

Q. & A. ON ELECTROSTATIC LOUDSPEAKERS

# RADIO & TV NEWS

*World's Leading Electronics Magazine*

JUNE  
1958  
35 CENTS

Special Features on—  
OUTDOOR P.A. SYSTEMS

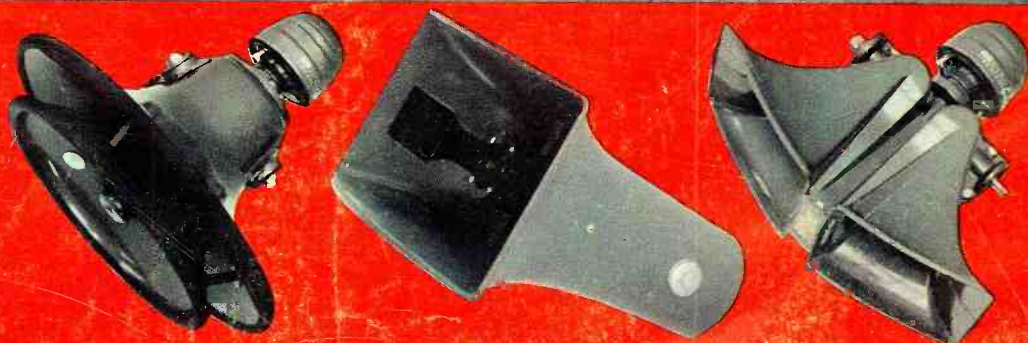
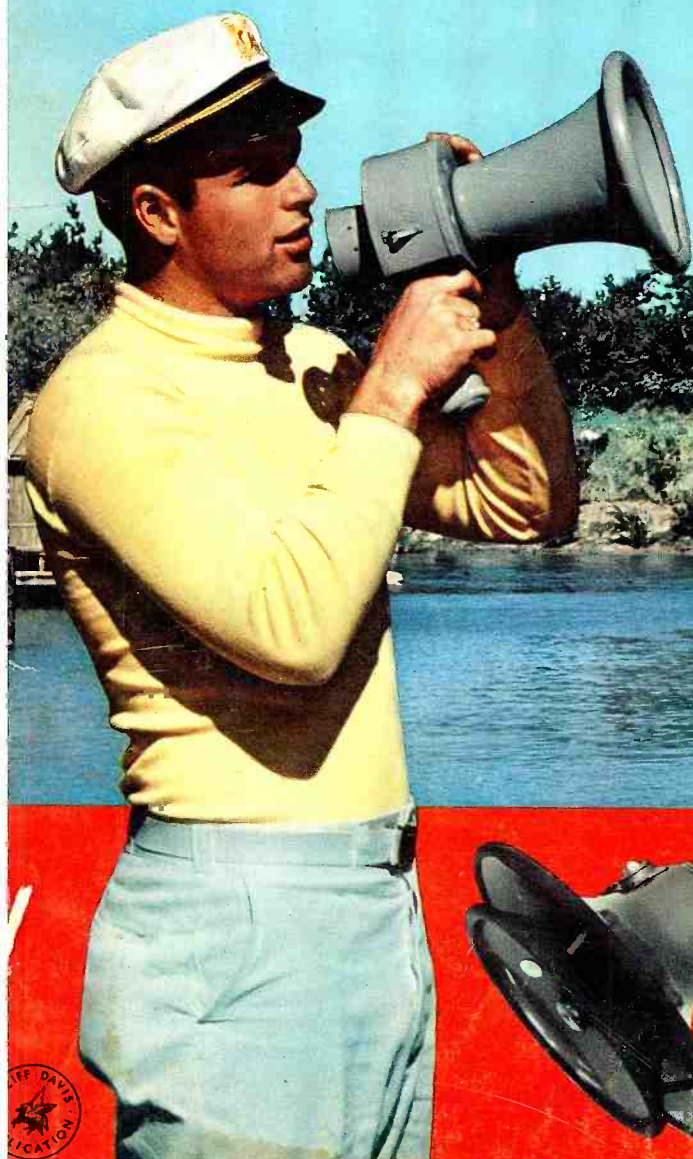





# How to make more money as an independent RAYTHEON BONDED ELECTRONIC TECHNICIAN



**Prominently display your Raytheon Bonded Certificate.** It impresses your customers just like a doctor's diploma or lawyer's certificate.



**Feature the Raytheon Creed Display and the Bonded Dealer Decal in your windows.** The Creed Display shows potential customers your Code of Business Ethics. The Decal identifies you as a nationally advertised Bonded Dealer.



**Carry "ID" Cards.** You and your technicians should always carry your Raytheon Identification Cards. Presenting the card puts your customers at ease when you must remove a set from the home.



**Advertise your Bonded Dealer standing.** Use the newspaper mats Raytheon makes available to you for local newspaper advertising. Rates are low, results high. Scripts for radio and TV spots are also available to you at no cost.



**Use the Yellow Pages.** List your shop as a Bonded Dealer shop in the Classified Telephone Directory — many customers select service dealers from this source.



**Make Mailings to Potential Customers.** Raytheon has available to you many attractive Post Card mailers and a special Bonded Dealer self-mailer. Regular mailings stimulate service business.



**Identify your shop.** This traffic stopping metal sign will tell all passersby that you are the Bonded Dealer in your community — the Bonded Dealer that Raytheon is presenting to America as the top TV-Radio technician in the country.

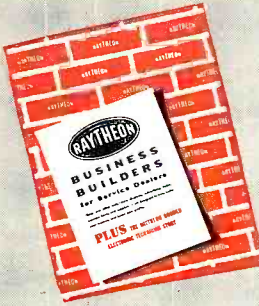

Finally, make the most of the hundreds of helpful sales and shop aids Raytheon has available to you. They're all shown in this Raytheon Business Builders booklet. Get a copy from your Raytheon Tube Distributor, today.

**P.S.** If you're not a Raytheon Bonded Dealer call the Raytheon Tube Distributor who sponsors the Bonded Program in your neighborhood. He'll tell you if you can qualify.



**RAYTHEON MANUFACTURING COMPANY**  
Receiving Tube and Semiconductor Operations

NEWTON 58, MASS. 55 Chapel Street	CHICAGO, ILL. 9501 Grand Ave. (Franklin Park)	ATLANTA 6, GA. 1150 Zonolite Rd. N.E.	LOS ANGELES 7, CALIF. 2419 So. Grand Ave.
--------------------------------------	--	--	--

Raytheon makes all these } Receiving and Picture Tubes, Reliable Subminiature and Miniature Tubes, Semiconductor Diodes and Transistors, Nucleonic Tubes, Microwave Tubes.





# Train at Home for SUCCESS in RADIO TELEVISION

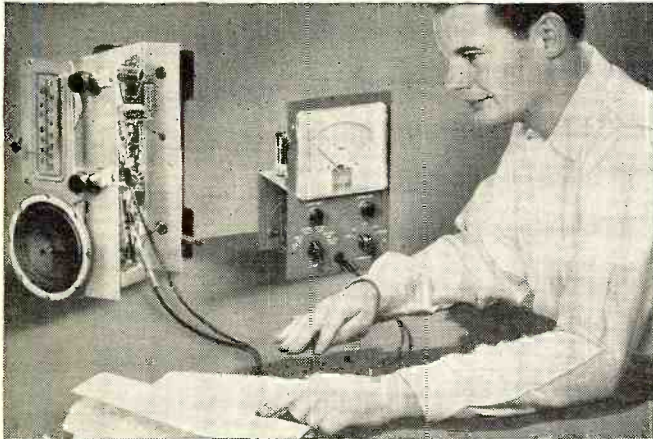

## You Learn at Home by Actual Practice

With NRI kits you build actual Radio-Television circuits and testing instrument. Practice locating and fixing Radio-Television troubles. Learn soon to earn extra money.



## Good Jobs in Radio-TV Communications

NRI trained men hold good jobs as operators and technicians in Radio and Television broadcasting stations, with Police, Marine and Aviation stations. Interesting work, good pay.



## There's Good Pay in Radio-TV Servicing

NRI trained technicians are needed, paid well, to help maintain 150 million home and auto Radios, 38 million TV sets. Color TV adding opportunities. Excellent field for spare time earning.

## Join the thousands N.R.I. has trained for Successful Careers in Radio-TV

Get the benefit of NRI's 40 years experience training men for success in this field. Get personal attention of experienced instructors. Also get practice with Radio-TV equipment—learn by *doing*—with kits supplied as part of your course. Courses are easy to learn. Most successful NRI men start without any knowledge of Radio, many without a high school education.



J. E. Smith  
Founder

## Find Out What Radio-TV Offers You

As trained Radio-TV Technician, you are prepared to supply much needed services. The technician is a respected and appreciated member of his community. Get Sample Lesson FREE. See how practical NRI has made learning at home. Mail the coupon. You also get 64-page Catalog telling about NRI, the lessons, equipment supplied, instruction services.

## N.R.I. TRAINED THESE MEN FOR SUCCESS



"I am a police captain and have a good spare time Radio-Television service business. Just opened new shop." C. W. LEWIS, Pensacola, Florida.



"Received my License and worked on ships. Now Chief Engineer Station WAPA. Grateful to N.R.I." R. D. ARNOLD, Rumford, Rhode Island.



"Enrolled while meat market manager. Got serviceman job. In a year my pay increased 50%." C. CARTER, San Bernardino, California.



"Have a Radar job. Also do spare time Radio-Television servicing. Have my own amateur Radio Station." F. ZAWAKE, Seranton, Pennsylvania.

## Added Income Soon—\$10, \$15 a Week in Your Spare Time

Soon after enrolling, many NRI students earn \$10, \$15 a week extra fixing sets in spare time. Vacuum Tube Voltmeter you build with parts we send helps you locate and fix troubles. Special lessons show you how. Many students use spare time earnings to pay for their training, and provide capital to start their own businesses when they get their National Radio Institute Diploma.

## Color TV Making More Jobs

Radio-Television is an industry noted for continued and spectacular growth. Number of trained men employed has increased steadily. Color TV and other late developments are creating need for more technicians. The future is very bright for trained men. Find out how you can get ready at low cost, on easy terms. Send for FREE Sample Lesson and Catalog. Mail coupon today—National Radio Institute, Dept. 8FE Washington 16, D. C.

## VETERANS—Approved under GI Bills

## MAIL COUPON TODAY

### NATIONAL RADIO INSTITUTE

Dept. 8FE, Washington 16, D. C.

Mail me Sample Lesson and 64-Page Catalog, FREE. (No Salesman will call. Please write plainly.)

Name \_\_\_\_\_ Age \_\_\_\_\_

Address \_\_\_\_\_

City \_\_\_\_\_ Zone \_\_\_\_\_ State \_\_\_\_\_

ACCREDITED MEMBER, NATIONAL HOME STUDY COUNCIL

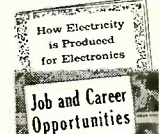

Send for Sample Lesson and Catalog FREE

RADIO & TV NEWS is published monthly by Ziff-Davis Publishing Company, William B. Ziff, Chairman of the Board (1946-1953), at 434 S. Wabash Ave., Chicago 5, Ill. Entered as second-class matter July 21, 1948, at the Post Office, Chicago, Ill., under the act of March 3, 1879. Authorized by Post Office Department, Ottawa, Canada, as second-class matter. SUBSCRIPTION RATES: one year U. S. and possessions, and Canada \$4.00; Pan American Union Countries \$4.50; all other foreign countries, \$5.00.



Reg. U. S. Pat. Off.

First in radio-television-audio-electronics

Average Net Paid Circulation 246,225

Radio & Television News • Radio News • Television News Trademarks Reg. U. S. Pat. Off.

# CONTENTS

JUNE, 1958

VOL. 59 ■ NO. 6

**Publisher**

**OLIVER READ, D. Sc., WIETI**

**Editor**

**WM. A. STOCKLIN, B. S.**

**Technical Editor**

**MILTON S. SNITZER**

**Service Editor**

**SIDNEY C. SILVER**

**Associate Editor**

**P. B. HOEFER**

**West Coast Editor**

**EDWARD A. ALTSHULER**

**Assistant Editor**

**J. JUSTER**

**Television Consultant**

**WALTER H. BUCHSBAUM**

**Art Editor**

**HERBERT ASCHER**

**Art and Drafting Dept.**

**J. A. GOLANEK  
JAMES A. ROTH  
MILTON WHELPLEY**

**Advertising Director**

**JOHN A. RONAN, JR.**

**Midwest Adv. Manager**

**W. ROBERT WOLFE**

**Western Adv. Manager**

**JOHN E. PAYNE**



**ZIFF-DAVIS PUBLISHING COMPANY**  
William Ziff, President; H. J. Morganroth, Vice-President; W. Bradford Briggs, Vice-President; Michael Michaelson, Vice-President and Circulation Director; Victor C. Stabile, Treasurer; Hershel B. Sarbin, Secretary; Albert Gruen, Art Director.

Editorial and Executive Offices  
One Park Avenue  
New York 16, N. Y. OR. 9-7200



MEMBER  
INSTITUTE OF



**BRANCH OFFICES:** Midwestern Office, 434 S. Wabash Ave., Chicago 5, Ill.; Western Office, Room 412, 215 W. 7th St., Los Angeles 14, Calif., John E. Payne, manager.

## INDUSTRY NEWS

Spot News.....	Washington Correspondent	25
New Transmitter for U.S. Satellite.....		82
All-Electronically Controlled Machine Tool Line.....		110

## HIGH FIDELITY AND AUDIO

Outdoor Public Address Systems.....	Norman H. Crowhurst	29
Electrostatic Loudspeakers—Questions and Answers.....	Warren Philbrook	36
Electronics at Disneyland.....		39
This Month's Cover.....		39
A "High-Power" Portable Paging System.....	Louis E. Garner, Jr.	45
New Compatible Stereo Disc.....	Milton S. Snitzer	53
FM Tuner Kit Features Novel "Front End".....		56
Hi-Fi—Audio Product Review.....		86
70 Watts with KT88's.....		94
Certified Record Revue.....	Bert Whyte	104
Sound on Tape.....	Bert Whyte	108

## TELEVISION-RADIO

For the Record.....	W. A. Stocklin	8
System Maintenance in Two-Way Mobile.....	Frank De Bra	34
I.F. Alignment? It's Easy!.....	Bob Eldridge	40
Your Business Telephone.....	William Leonard	58
Mac's Service Shop.....	John T. Frye	62
New G-E FM Detector.....	Christopher Burns	80
Service Association of the Month (MARTS, Milwaukee).....		100
Antenna News.....		102
Service Notes.....		116
Service Industry News.....		118

## TEST EQUIPMENT

Extend Your Signal Generator's Range.....	J. E. Pugh, Jr.	42
Universal Test Leads.....	Tracy Diers	52
Boost Your Scope's Sensitivity.....	Paul S. Lederer	54
New Tube Tester Data.....		92
Improved Sine-to-Square Wave Adapter.....	Rufus P. Turner	107

## AMATEUR

Adding 21 mc. to the Off-Center-Fed Antenna.....	Dr. R. G. Minarik, W9GJY	48
Compact 35-Watt Standby Transmitter.....	Hal Bumbaugh, W6HI	59

## ELECTRONIC CONSTRUCTION

A Slave Flash Trigger.....	R. L. Winklepleck	33
The Gremlin Sentry—an Automatic Control Switch.....	Robert Landis	49

## DEPARTMENTS

Letters from Our Readers.....	12	Manufacturers' Literature.....	96
Within the Industry.....	18	Technical Books.....	122
Sales Aids.....	91	What's New in Radio.....	125

Copyright © 1958 by Ziff-Davis Publishing Company. All rights reserved.  
SUBSCRIPTION SERVICE. All communications concerning subscriptions should be addressed to Circulation Dept., 434 S. Wabash Ave., Chicago 5, Ill. Subscribers should allow at least four weeks for change of address. Include your old address as well as new—enclosing, if possible, an address label from a recent issue of this magazine.

CONTRIBUTIONS: Contributors are advised to retain a copy of their manuscripts and illustrations. Contributions should be mailed to the New York Editorial Office and must be accompanied by return postage. Contributions will be handled with reasonable care, but this magazine assumes no responsibility for their safety. Any copy accepted is subject to whatever adaptations and revisions are necessary to meet the requirements of this publication. Payment covers all author's, contributor's, and contestant's rights, title, and interest in and to the material accepted and will be made at our current rates upon acceptance. All photos and drawings will be considered as part of the material purchased.



DeVry Tech *CAN PREPARE YOU IN SPARE TIME AT HOME...*

for a Profitable Future in

# Electronics

as used in

## Guided Missiles

ETC.

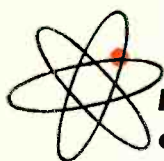

**No Previous Technical Experience  
or Advanced Education Needed!**

If you think you need a "pull", advanced education or previous technical experience to prepare for a profitable career in the fast-growing, big opportunity field of Electronics—you're mistaken. The most important thing is a sincere desire to be somebody and to get somewhere.

During the past 27 years we have successfully trained farmers, store clerks, factory hands and men of practically every calling from 17 to 55. If these men can do it in their spare time, why can't you?

Regardless of your experience, we urge you to fill in coupon below for full FREE facts about our modern training that follows the same basic method used in our Chicago and Toronto Laboratories. It will cost you nothing for information that may prove to be the turning point in your career. Act now! Send coupon TODAY!

### Draft Age?

We have valuable information for every man of draft age; so if you are subject to military service, be sure to check the coupon.

### Live-Wire Employment Service

DeVry Tech's Placement Department is in contact with some of the best-known employers in the Electronics field. The service is free to all graduates—and DeVry Tech's record in helping to place men has been outstanding.

*An INDEX to a Better Job,  
a Brighter Future*

Communications • Radar • Television

Micro-Waves • Radio • Computers • Industrial Electronics • Automation Electronics

### FREE BOOKLET!

We'll give you a free copy of an interesting booklet, "Electronics and YOU."

See for yourself how you may take advantage of the opportunities in this fast-growing field.



"One of North America's Foremost Electronics Training Centers"



Accredited Member  
of National  
Home Study Council

**DEVRY TECHNICAL INSTITUTE**  
CHICAGO 41, ILLINOIS  
FORMERLY  
DEFOREST'S TRAINING, INC.



### MAIL COUPON TODAY!

DeVry Technical Institute  
4141 Belmont Ave., Chicago 41, Ill., Dept. RN-6-0

Please give me your FREE booklet, "Electronics and YOU," and tell me how I may prepare to enter one or more branches of Electronics as listed above.

Name \_\_\_\_\_ Age \_\_\_\_\_

Street \_\_\_\_\_ Please Print \_\_\_\_\_ Apt. \_\_\_\_\_

City \_\_\_\_\_ Zone \_\_\_\_\_ State \_\_\_\_\_

Check here if subject to military training.

DeVry Tech's Canadian Training Center is located  
at 626 Roselawn Avenue, Toronto 12, Ontario

#2019



**POWER TUBES  
E-290T**  
triodes, tetrodes,  
pentodes and beam tubes  
— 8 pages.

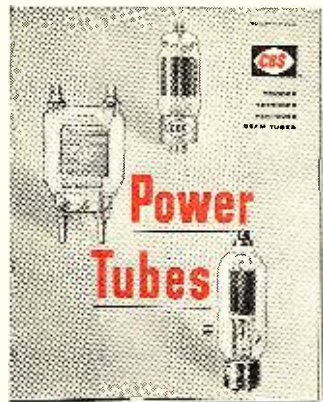

**MILITARY AND SPECIAL-  
PURPOSE TUBES  
E-290S**  
military, computer,  
uhf, hi-fi and pass tubes  
— 12 pages.



**GAS TUBES AND  
POWER RECTIFIERS  
E-290C**  
gas diodes, gas triodes  
and tetrodes (cold cathode  
and thyatron) and power  
rectifiers — 16 pages.



**PHOTOTUBES AND  
PHOTOCELLS  
E-290P**  
vacuum and gas  
phototubes and photocells  
— 12 pages.

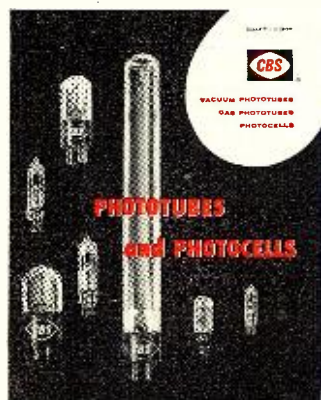

Now...the most  
comprehensive  
industrial  
tube line  
...over 400  
CBS types!

In keeping with the growing importance of industrial tubes, CBS-Hytron has more than doubled its industrial tube line. Over 400 types make it the most extensive line. For example, CBS-Hytron now offers the widest selection of gas tubes, phototubes and photocells.

The four industrial tube catalogs illustrated include: reference charts with ratings and typical operating conditions, basing and circuit diagrams, and application notes. Ask your CBS-Hytron distributor or write us for the ones you need.



**CBS-HYTRON**, Danvers, Mass.  
A Division of  
Columbia Broadcasting System, Inc.

*For the best in entertainment tune to CBS*



**IF JOBS LIKE THESE ARE "ON YOUR MIND"...**

*... but you can't qualify because you lack*

**ADVANCED TECHNICAL KNOWLEDGE...**

**SEND NOW FOR CREI'S NEW FREE BOOKLET**

It's crammed with facts and data—containing a time-proved plan to make you ready for the big jobs and a high-salaried career now being offered in

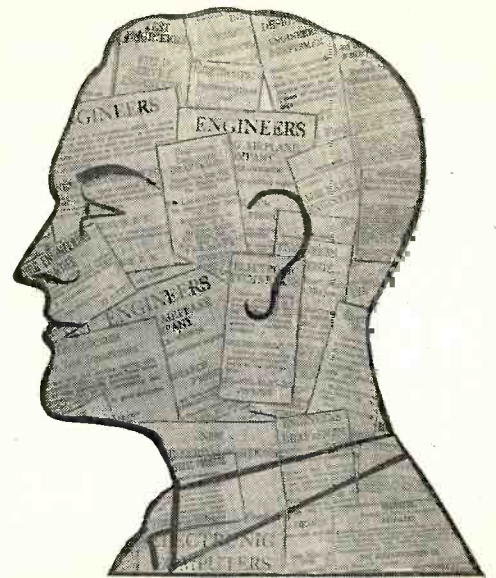

**ELECTRONICS — TELEVISION — BROADCASTING — GUIDED MISSILES — INSTRUMENTATION  
RADAR — COMPUTERS — AUTOMATION — ASTRONAUTICS — SERVOMECHANISMS  
AERONAUTICAL ELECTRONICS — TELEMETERING — COMMUNICATIONS — MANUFACTURING**

Hundreds of ads appearing almost daily in magazines and newspapers—all over the country—show how desperately the electronics industry needs trained men. On the other hand, they give you a good idea of what opportunities await you—if you get advanced technical training now. And no wonder trained men are needed! Look what's happening in "Astronautics," of which the earth satellite is just the most recent, but by no means the ultimate example. Computers, Radar, Aeronautical Electronics—are all booming—all need trained electronics men. Top manufacturers sold upwards of 13.5 billions of dollars worth of electronic equipment last year. By 1965 it's expected the radio-electronics industry will do about 22 billion dollars of business per year.

What do these figures mean to you? They mean that thousands of new electronics jobs have been added to the great, expanding field of electronics.

**LITERALLY THOUSANDS ARE NEEDED!**

You are needed—for development, research, design, production, testing, inspection, manufacture, broadcasting, telecasting, servicing. But you can qualify only if you take time to advance your knowledge... if you take 2 minutes right now to write for the free CREI booklet, with no obligation.

**SHORTEST DISTANCE TO A GOOD CAREER IS CREI TRAINING**

If you follow the plan outlined in our free booklet, you will be in line for promotion and pay increases in short order. Read what these typical CREI graduates have to say:

"In this time of less than two years, I have almost doubled my salary and have gone from wire-man to engineering assistant and now to junior engineer. I have CREI to thank."  
—Frank A. Eckert, 22 Clover Lane, Levittown, Pa.

"I chose CREI training upon recommendation of two top engineers. Before I completed the course, I became transmitter chief of a 5 kw station. I am now employed as a technician at a 100 kw TV station and in spare time have a good TV sales and service business."  
—Arlie D. Patton, 203 Burke Ave., San Antonio, Tex.

By method, experience, and personnel—CREI is equipped to teach you what

you will need when you translate your study into work. As proof that CREI knows what industry wants, many leading companies recommend CREI training for their own personnel. Among them: United Airlines, Canadian Broadcasting Corporation, Trans-Canada Airlines, Douglas Aircraft Co., The Martin Co., Columbia Broadcasting System, All-American Cables and Radio, Inc., Gates Radio Co., Canadair Ltd., Federal Electric Corporation and U. S. Information Agency (Voice of America). Their choice of training for their own personnel is a good cue for your choice of a school.

**TOP FIRMS LOOK FOR CREI MEN**

A CREI diploma itself is ample proof to many leading companies that a man is worth hiring. Moreover, employers contact us regularly for graduates to fill good jobs. Our placement bureau cannot keep up with the demands.

What do you want? To pass FCC exams? Start your own business? CREI has helped others reach these goals, and can help you. Or, do you want to go after good-paying electronics jobs, secure, permanent careers like those advertised above? Whatever your choice,

CREI can help you as it has helped thousands of men—provided you have the ambition to follow the plan.

**CREI ALSO OFFERS RESIDENCE TRAINING**

CREI Residence School in Washington, D. C. offers training at same high technical level. Day and evening classes start at regular intervals. Qualified residence school graduates earn degree: "Associate in Applied Science." Check coupon for catalog.

**VETERANS**

If eligible for training under the new G.I. Bill of Rights, check the coupon for full information.

*What's the next step? Certainly get more information. Mail the coupon below today, or write Capitol Radio Engineering Institute, Dept. 116-E, 3224 16th St. N.W., Washington 10, D. C.*



**MAIL FOR FREE BOOKLET**

**CAPITOL RADIO ENGINEERING INSTITUTE**

ECPD Accredited Technical Institute Curricula • Founded 1927

Dept. 116-E 3224 16th St., N.W. Washington 10, D.C.

Please send me your course outline and FREE illustrated Booklet "Your Future in the New World of Electronics"... describing opportunities and CREI home study courses in Practical Electronic Engineering Technology.

- CHECK FIELD OF GREATEST INTEREST
- Radar, Servo and Computer Engineering Technology
  - Electronic Engineering Technology
  - Broadcast (AM, FM, TV) Engineering Technology
  - Television Engineering Technology
  - Aeronautical Electronic Engineering Technology

**GI**

Name..... Age.....  
Street.....  
City..... Zone..... State.....  
Check:  Home Study  Residence School  Korean Veteran

**NOT FOR BEGINNERS.** If you have had a high school education, and experience in electronics—and realize the need of high-level technical knowledge to make good in the better electronic jobs—you can qualify for CREI home study training. (Electronics experience is not required for admission to CREI Residence School.) Please fill in the following information:

EMPLOYED BY.....  
TYPE OF PRESENT WORK.....  
EDUCATION: YEARS HIGH SCHOOL.....  
YEARS COLLEGE.....  
ELECTRONICS EXPERIENCE.....



Want a box  
at the opera?



## BUILD YOUR OWN!

A Bozak E-300 Kit—with Bozak Speakers, worthy associated equipment, and fine program material—is your lifetime pass to all the world's great music, at surprisingly low cost!

The Kit includes every needed part, assembles in a few hours. As an infinite baffle, the E-300 requires the very finest speakers: for a wide-range 2-way system, the Bozak B-207A; add a Bozak B-209 Mid-Range and N-10102 Crossover Network for finest one-w woofer 3-way performance.

Going stereo? A duplicate "300" will transform your livingroom into a living stage—your easy chair into the best seat in the world of music!

Hear the Bozaks at a Franchised Bozak Dealer. Write for literature.

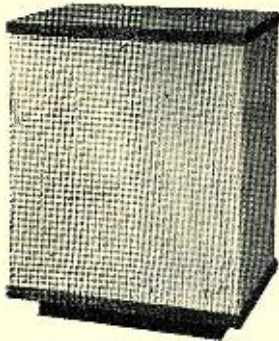

The Assembled E-300 Kit



B-209

B-207A

N-10102



The R. T. BOZAK Sales Co.  
Darien, Connecticut

For the **RECORD.**

## DOES LICENSING WORK?

**M**OST past debates over the pros and cons of service licensing, of necessity, have taken place in empty air. With little actual experience to go on, both protagonists and antagonists have had to come around, sooner or later, to sheer speculation on what could or could not happen.

Actually, it will be many a year before licensing—of one kind or another—is sufficiently widespread to make a definite appraisal possible. Nevertheless, we must be grateful for the fact that there is at least one place where licensing has been in effect long enough so that arguments on the subject need no longer be entirely academic.

In January 1957 a law licensing TV service dealers and technicians went into effect in Detroit, Michigan. In this instance, the Television Service Association of that city had a definite hand in shaping that legislation, with the hope that the result would be satisfactory to service dealers and technicians as well as to the city administration and the public. The cooperation between that group and the local license board has been a significant factor in whatever success the law has enjoyed. In this automobile capital, at least, we can say after more than a year of trial that some good things have come out of the law.

An independent poll by a visiting service dealer indicates that a substantial majority of Detroit's service dealers are satisfied with the law and the manner in which it is being administered.

The relatively small number of service dealers who were primarily responsible for the chicanery that gave the entire local industry a black eye have had their activities drastically curbed.

Relating to this change in the industry environment, "bait" advertising has been eliminated for all practical purposes. Once Detroit papers were heavy with ads offering TV service at ridiculously low prices. The unethical operators who went fishing for customers with this approach could always make up their profit by "adjusting" their final bills to cover work that was not necessarily done. This placed honest service people in an impossible competitive situation. Relieved of this pressure, honest dealers and technicians are able to price realistically and report on work done in a straightforward way. Psychologically the service industry has won new stature with and

new confidence from TV set owners.

The ordinance has *not* seemed to be a hardship on smaller, one-man shops, or even on earnest part-timers. Fees for dealer licensing and technician certification, along with other requirements, have not been set up to discriminate in favor of the well-established organization.

Where dissatisfied set owners have initiated complaints against service dealers, the administrators of the law have been able to work out amicable settlements in a high percentage of the cases. When it has been necessary to take offending dealers to court, however, the record of convictions has been running close to one hundred per-cent. It is interesting to note, in this connection, that the administrators consider their major task as being one of education.

May we conclude that licensing works? So it would seem—in the case of a specific law in a specific city. We must not lose sight of the fact that the Detroit experiment is not the first of its kind, and that there have been differing reactions elsewhere. In some cases, there have been charges and counter-charges to the effect that some elements of the industry are using the law to gain advantage over competitors. In other cases, such legislation simply provides that anyone wishing to service for profit may do so by paying his annual fee. Such an arrangement does wonders for a municipal budgetary problem, but provides no protection of any kind for either set owner or set repairer. In some cases, an inequitable law may cripple a healthy service industry by making it a scapegoat for blind public fury.

The nature of a specific law and its eventual administration is important to the answer of our leading question. Certainly, *one kind* of licensing can be made to work. In cases where public pressure seems to make licensing inevitable, it would therefore seem that interested dealers and technicians should forego whatever reservations they have to join in shaping and implementing the right kind of legislation.

On the other hand, it would be dangerous for them to assume that *any* kind of licensing can be a magic wand that will wave away all industry ills. Those who expect it to be an antidote for technical incompetence, poor business management, improper handling of customer relations, and lack of initiative will continue to get what they deserve. . . . W.S.



# See The Best Before You Build!

SEE THE AMAZING  
**ALLIED knight-kits**  
 IN THE WORLD'S LEADING ELECTRONIC SUPPLY CATALOG



**FREE!** send for it now

THERE'S A knight-kit FOR EVERY NEED

- LOWEST COST
- EASIEST TO BUILD
- LATEST DESIGN
- FINEST QUALITY

Do-It-Yourself: **SAVE UP TO 50%**



**knight-kits:**  
**BEST BUY**  
**HI-FI**  
**KITS**

- 18-Watt Amplifier
- 30-Watt Amplifier
- 25-Watt Amplifier
- 20-Watt Amplifier
- 10-Watt Amplifier
- FM-AM Tuner
- FM Tuner
- Preamplifier
- 2-Way Speaker System
- 3-Way Speaker System

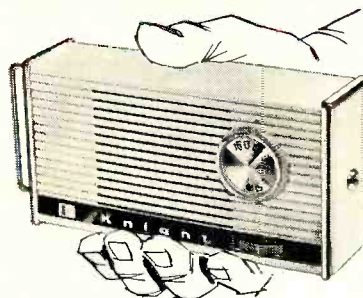

**knight-kits:**  
**BEST BUY**  
**HOBBY**  
**KITS**

- "Space-Spanner" Radio
- "Ocean-Hopper" Radio
- "Ranger" AC-DC Radio
- 2-Way Intercom
- Electronic Lab Kits
- Crystal Set
- Wireless Broadcaster
- 5-Transistor Portable
- 2-Transistor Pocket Radio
- Transistor Lab Kit
- 1-Transistor Radio
- Photoelectric System
- Electronic Photoflash
- Phono Oscillator



**knight-kits:**  
**BEST BUY**  
**INSTRUMENT**  
**KITS**

- 5" Oscilloscopes
- Vacuum Tube Voltmeter
- Tube Tester
- VOM's
- RF Signal Generator
- Signal Tracer
- Audio Generator
- Sweep Generator
- R/C Substitution Boxes
- Voltage Calibrator
- Capacitor Checker
- R/C Tester
- Transistor Checker
- Flyback Checker
- Battery Eliminator



**knight-kits:**  
**BEST BUY**  
**AMATEUR**  
**KITS**

- All-Band Ham Receiver
- Self-Powered VFO
- 100 kc Crystal Calibrator
- 50-Watt Transmitter
- RF "Z" Bridge
- Code Practice Oscillator

## ALLIED RADIO

404-PAGE ALLIED CATALOG

**FREE!**

Send for this value-packed catalog featuring the complete ALLIED KNIGHT-KIT line, as well as the world's largest stocks of everything in Electronics. You'll want this valuable, money-saving Buying Guide.

WRITE FOR YOUR **FREE** COPY TODAY



ALLIED RADIO CORP., Dept. 121-F8  
 100 N. Western Ave., Chicago 80, Ill.

Send FREE 1958 ALLIED 404-Page Catalog

Name \_\_\_\_\_

Address \_\_\_\_\_

City \_\_\_\_\_ Zone \_\_\_\_\_ State \_\_\_\_\_



**Sylvania comparisons point out—**

# The big difference

**Here's the inside story on why local "off-brands" don't measure up to Silver Screen 85® standards**

**I**F you're like most dealers, you know off-brand tubes don't have the same quality standards as first-line tubes. To help you see how big the difference is, Sylvania purchased a nationwide sample of sixty 21YP4A made by 19 different local tube makers. These tubes were put through the same production tests that all Sylvania tubes must pass.

**Not a single local off-brand passed all 54 mechanical and electrical tests!** Many of these were minor defects making little or no difference in whether or not the tube "lit up." But look how loose manufacturing controls can affect the important features of light output, focus, and life!

## LIGHT OUTPUT

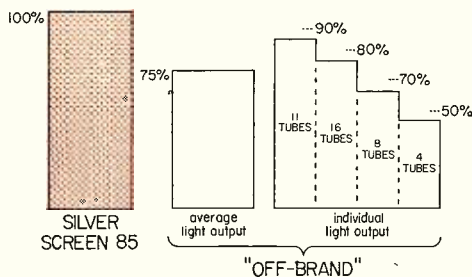

So far, 39 off-brand tubes have been compared with the *minimum* light output of Silver Screen 85. Five additional tubes couldn't even be tested. Eleven tubes were less than 90% as bright as the minimum for Silver Screen 85; 16 were less than 80%; 8 were less than 70%; and 4 were *less than 50%* as bright. Since most Silver Screen 85 tubes average as much as 125% of minimum standards, the difference becomes even greater. Small wonder that Silver Screen 85 is the easy way to more satisfied customers.

## FOCUS

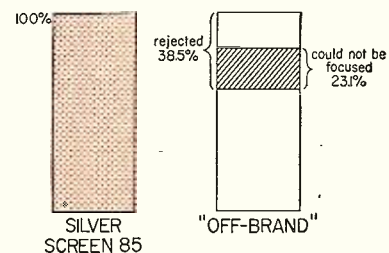
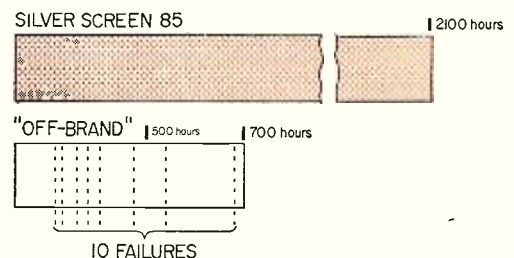

Chart 2 shows how these same 39 tubes stacked up to registered limits on focus voltage. 38.5% were rejected under these limits. Over half of all those rejected could not be focused in a TV receiver. Small wonder then that "Silver Screen 85" pictures are sharper, brighter, clearer.

## LIFE TEST



Nineteen off-brand tubes were placed on Sylvania's standard 2000-hour life test. Chart 3 tells you how fast these tubes developed slow-heating cathodes. Over half, or ten units, failed to go beyond the 700-hour mark. Small wonder then that Silver Screen 85 gives you less troublesome callbacks.

Of all the off-brand tubes tested, Sylvania engineers estimate that 43% probably would not have operated properly in a TV set. Why gamble your reputation, customer satisfaction, and success. It's just *good business* to sell up to "first line" picture tubes; Silver Screen 85 picture tubes.



# in Picture Tubes!



Take it from Bill Shipley: "Silver Screen 85' consumer advertising makes it easy to *sell-up* to 'first line' picture tubes."

**New TV Campaign dramatizes test results . . . sells consumers up to "first line" picture tubes . . . builds more profitable sales and satisfied customers for dealers everywhere.**

Sylvania's fabulous new family, "The Real McCoys," is one of the top new television shows of the season and has been named the "Sleeper of the Year." Week after week, on the "Real McCoys" Sylvania is making millions of set owners aware of the big difference in picture tubes.

New commercials like the "Brightness Test" are pre-selling consumers on the "first line" performance of Silver Screen 85.

For dealers everywhere it means more and more customers asking for "Silver Screen 85"—Pre-sold customers make satisfied customers—strengthening your business reputation and building long-range profitable growth.

Sylvania has designed this powerful new selling tool for you. Get behind it and *sell-up* to "first line" Silver Screen 85 picture tubes.

## Highlights of Sylvania's TV "Brightness Test."



"Don't be fooled by picture tubes that look alike — they don't act alike."



Sylvania's Silver Screen 85 is over twice as bright as this "off-brand" tube.



"Insist on a nationally known Silver Screen 85—there's one to fit every make TV."



# SYLVANIA

SYLVANIA ELECTRIC PRODUCTS INC.  
1740 Broadway, New York 19, N. Y.  
In Canada: Sylvania Electric (Canada) Ltd.  
University Tower Bldg., Montreal

LIGHTING • TELEVISION • RADIO • ELECTRONICS • PHOTOGRAPHY • ATOMIC ENERGY • CHEMISTRY-METALLURGY

June, 1958

11



NOW...

*stereophonic*

HIGH  
FIDELITY  
*components*

by

**Pilot**



SP-215

Stereo Preamplifier

\$189.50



SM-244

Stereo Preamp  
and Amplifier

\$189.50

PRICES SLIGHTLY HIGHER IN WEST

For complete details,  
mail this coupon today.

**Pilot** Radio Corporation DQ-6  
37-06 36th St., L. I. C. 1, New York

Please send literature covering  
Pilot Stereo Components.

NAME \_\_\_\_\_

ADDRESS \_\_\_\_\_

CITY \_\_\_\_\_ ZONE \_\_\_\_\_ STATE \_\_\_\_\_

Manufacturer in electronics  
for over 39 years



# Letters

from our Readers

Every month we are deluged with mail from our readers requesting product recommendations, specific design information, and specialized technical assistance. Because of the very many personal variables in evaluating products, we cannot do more than to refer you to our reports on products that we have actually checked. And although we would like to help with design and extensive technical information, our volume of mail makes it impossible for us to devote the amount of time that would be needed to be fully helpful. So, keep the letters coming, but go easy on the above types of requests. . . The Editors.

### BASIC ELECTRONIC COUNTING

I read with interest the article by Ed Bukstein in the March issue of RADIO & TV NEWS entitled "Basic Electronic Counting." I thought I would add a note of encouragement for more articles of this nature.

There is, I believe, practical knowledge to be gained by reading articles on computers which are presented in a logical and concise manner. It allows an insight into the vast complexities of automation and electronic computer operations.

MONTE L. WALPOLE  
Engineering Staff, KSD, KSD-TV  
St. Louis, Missouri

To the Editors:

As a subscriber to your RADIO & TV NEWS, I look forward each month to your many fine articles, especially on servicing TV.

The article entitled "Basic Electronic Counting" by Ed Bukstein in the March edition is a very interesting branch of electronics, and I would certainly like to see more articles on binary computation.

LECIL MEYER  
Meyer's Radio & TV Service  
Grandbury, Texas

To the Editors:

Would appreciate several more articles to follow up "Basic Electronic Counting" by Bukstein (March, RADIO & TV NEWS).

This is the best written article on this subject I have seen. Let's get into the subject a little deeper.

PHILIP L. BRUCE  
Long Beach, California

To the Editors:

I think the straightforward treatment in the "counting" article is excellent. I suggest that more articles on this timely subject be presented in the same lucid manner.

L. A. W. EAST  
Montreal, Quebec

To the Editors:

I find your article on "Basic Electronic Counting," March, 1958 issue, most interesting. I would like to have more of this type of article. Congratu-

lations on a fine technical magazine! I am looking forward to your next issue.

CARLTON PIEPER  
Hampton, Virginia

OK, OK. We were really swamped with favorable response on the article. The second in the series has already appeared in May, and more are in the works for future issues.—Editor.

\* \* \*

### 30-WATT TRANSISTOR MODULATOR

In answer to the many hams who have written us requesting substitute transistors for the 2N278's used in the "30-Watt Transistor Mobile Modulator" (January 1958 issue), here is what the author has to say.

To the Editors:

At present I know of only two other manufacturers of transistors equivalent in power-handling capability to the Delco 2N278. These are Honeywell, producer of the H-2 and related units for switching and servo applications; and Cle vite, which is reported to be sampling equipment manufacturers with a newly developed unit of high power rating. Both of these, however, are more costly than the Delco 2N278.

A great many types of lower powered transistors are available at prices about 1/4 that of the 2N278. Most of these are rated for 8 watts maximum audio output per pair. Although it might be possible to parallel 3 or 4 carefully selected pairs to obtain a higher total power output, certainly new problems of matching would be raised, and the cost saving would be small. Due to the difficulty of obtaining matched units in quantities greater than one pair, I have not tried this method myself.

Very likely you have received inquiries regarding the possibility of using Delco 2N277's in place of 2N278's. The 2N277 has a low breakdown voltage rating and is not suitable for this particular modulator application.

There is one encouraging note. As a consequence of the interest in the circuit there has been a recent 15% price



Get into

# TELEVISION RADIO-ELECTRONICS



**LEARN ALL 8 PHASES  
BY SHOP METHOD**

**OF THE INDUSTRY  
HOME TRAINING**

1. Television . . . including Color TV
2. Radio . . . AM, FM
3. Industrial Electronics
4. Communications
5. Sound Recording & Hi-Fidelity
6. Automation
7. FCC License Preparation
8. Radar & Micro Waves

Let National Schools of Los Angeles, a Practical Resident Technical School for over 50 years, train you at home by Shop-Method for unlimited opportunities in All phases of TV, Electronics, Radio.

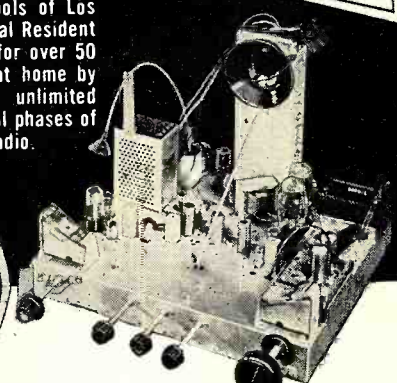

**You get 19 big kits  
of equipment!**

**GOOD JOBS . . . MORE MONEY  
SECURITY . . . ALL CAN BE YOURS**

YOU are needed in the great modern Television-Electronics industry. Trained technicians are in growing demand, at excellent pay, in sales and service, manufacturing, broadcasting, telecasting, communications, research, and many other important branches of the field. National Schools Master Shop-Method Training, with newly added lessons and equipment prepares you in your spare time right in your own home for these fascinating opportunities. **OUR OUTSTANDING METHOD IS PROVED BY THE SUCCESS OF GRADUATES ALL OVER THE WORLD!**

**YOUR TRAINING IS ALL INCLUSIVE**

We prepare you for a long list of job opportunities. Thousands of TV and Radio receivers are being sold every day—more than ever before. And, now, Color TV is here. Applications of Electronics in industry—**AUTOMATION**—are growing in tremendous strides. The whole field is alive—opening up new, important jobs rapidly. National Schools complete training program qualifies you in all phases of the industry.

**YOU EARN WHILE YOU LEARN**

Many students pay for their entire training—and more—with spare time earning. We'll show you how you can, too! Early in your course you receive material that shows you how to earn extra money servicing TV and Radio receivers, appliances, etc., for friends and acquaintances.

**YOU GET EVERYTHING YOU NEED**

Clear, profusely illustrated lessons, shop-tested manuals, modern circuit diagrams, practical job projects—all the valuable equipment shown above—many other materials and services—consultation privilege with our qualified staff, and Graduate Employment Service. **EVERYTHING YOU NEED** for outstanding success in Electronics.

**INDUSTRY NEEDS YOU. NATIONAL SCHOOLS  
WILL TRAIN YOU. SEND FOR FACTS TODAY  
NO OBLIGATION.**

**YOU LEARN BY SHOP METHOD . . .** you do servicing, circuit analysis, and do over 100 down-to-earth experiments. You build a Superhet Receiver and a modern TV Receiver, from the ground up, including a new, big screen picture tube. You also receive a professional, factory-made **MULTI-TESTER**. All of this standard equipment is yours to keep . . . at just one low tuition.

**RESIDENT TRAINING AT LOS ANGELES**

If you wish to take your training in our Resident School at Los Angeles, the world's TV capital, start NOW in our big, modern Shops, Labs and Radio-TV Studios. Here you work with latest Electronic equipment—professionally installed—finest, most complete facilities offered by any school. Expert, friendly instructors. Personal attention. Graduate Employment Service. Help in finding home near school—and part time job while you learn. Check box in coupon for full information.

Approved for  
GI Training



**NATIONAL SCHOOLS**  
LOS ANGELES 37, CALIF.

**FREE!  
VALUABLE BOOK  
& SAMPLE LESSON  
—Just Send  
Coupon!**



**NATIONAL SCHOOLS**

TECHNICAL TRADE TRAINING SINCE 1905  
LOS ANGELES 37, CALIFORNIA

**GET FAST SERVICE—MAIL NOW TO  
NATIONAL SCHOOLS, DEPT. RH-68**

4000 S. FIGUEROA ST. LOS ANGELES 37, CALIF.

Rush free TV-Radio "Opportunity" Book and sample lesson. No salesman will call.

NAME \_\_\_\_\_ AGE \_\_\_\_\_  
ADDRESS \_\_\_\_\_  
CITY \_\_\_\_\_ ZONE \_\_\_\_\_ STATE \_\_\_\_\_

Check if interested ONLY in Resident School training at Los Angeles.  
VETERANS Give date of Discharge \_\_\_\_\_



# MASTER THE BASICS OF TELEVISION

the easy RIDER "picture book" way

## BASIC TELEVISION by Dr. Alexander Schure

NOW AVAILABLE

The whole world of black and white television is before you for only \$10.00. You can master the basics of television easily, rapidly and thoroughly with this 5-volume "learn by pictures" training course.

### It's so easy to learn

Here's how this easy, illustrated course works. Every page covers one complete idea! There's at least one big illustration on that same page to explain it! You build a thorough, step-by-step knowledge at your own pace—as fast as you yourself want to go.

### No experience, education needed

BASIC TELEVISION uses the same methods that have proven so successful in the famous Rider picture books on electricity and electronics. All that is assumed is that you have a knowledge of radio. Every phase of television is made instantly clear—explained in plain English supported by carefully prepared, large and exciting drawings that make every idea crystal clear.

#198, soft cover 5 volumes, \$10.00 per set;

## NEW BOOKS FOR GREATER

**HOME AIR CONDITIONING** by J. Derman, H. Seaman, F. Makstein. Modern up-to-the-minute text provides a firm foundation in air conditioning theory upon which the practical know-how for installation and repair can be built. Starting with the basic physics of air conditioning, all component parts including compressors, condensers, capillary tubes etc. and their functions are covered. Typical window and packaged installations are described and illustrated. Smaller commercial installations are included. Trouble-shooting and repair techniques explained. Recent and future developments in air conditioning covered. More than 100 illustrations support the text. \$3.50.

**METALLIC RECTIFIERS AND CRYSTAL DIODES** by Theodore Conti. Growing use of metallic rectifiers and crystal diodes in computers and guided missiles as well as in radio television and telegraph circuitry makes this book of great interest to the engineer, technician and experimenter. Covering construction, characteristics, basic design data, applications, trouble-shooting repair and replacement, this book presents the basic information enabling the reader to understand and apply these components with sure results. #213, soft cover, \$2.95

**ELECTROSTATICS** edited by Alexander Schure, Ph.D. This volume, on one of the cornerstones in the study of electricity, considers fundamental physical units and quantities preparatory to the study of Columb's Law and Gauss' Law. The electrical field is considered both quantitatively and qualitatively making liberal use of worked out examples. #166-17, \$1.35.

**INDUSTRIAL CONTROL CIRCUITS**, by Sidney Platt —Control circuits are responsible for the rigid regulation and control of countless industrial processes. They constitute the core of industrial electronics. This book covers those control applications most frequently encountered in industrial electronics. The uses of industrial control circuits are discussed and described in detail, showing how basic electronics is applied to these circuits. #202, soft cover, \$3.90.

**STEREOPHONIC SOUND**, by Norman H. Crowhurst — World-famous audio authority Norman H. Crowhurst's new book is the first true assessment of this exciting new medium for realistic sound. 128 pp., illus. #209, \$2.25.

**REPAIRING TELEVISION RECEIVERS**, by Cyrus Glickstein. The most modern completely practical book, written by an expert with long experience in television receiver repair. Devoted to trouble-shooting and repair techniques which are modern, yet down-to-earth. Covers the use of simple as well as elaborate test equipment of all kinds. Profusely illustrated. Soft Cover, 212 pp., 5 1/2 x 8 1/2", illus. #191, Only \$4.40.

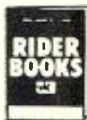

FREE! Handsome genuine leather, gold-stamped book-mark, if you write today for FREE Catalog RTN-6.



Buy these and many other RIDER BOOKS at your electronics parts jobber, book store or department store book department. Look for the Rider Bookseller. If your favorite store does not sell the Rider books you want, order direct. Add state, city tax where applicable. Canadian prices 5% higher.

**JOHN F. RIDER PUBLISHER, INC.**

116 West 14th Street,  
New York 11, N.Y.

In Canada: Charles W. Pointon, Ltd. 6 Alcina Ave., Toronto, Ontario

### 5 complete volumes

It starts with the transmitter and discusses in detail the following subjects: Volume 1 deals with the transmitter; the handling and the operation of the camera; formation of the picture signal and the general content of the transmitter. Volume 2 covers the organization of the entire TV receiver treating each section individually from antenna to picture tube. Volumes 3, 4 and 5 contain the TV receiver circuit explanations. Each volume covers a specific number of sections in the receiver. In effect, the presentation is like a spiral—first an overall view of the whole and then the detailed explanation of each part. The most perfect modern teaching technique. The result—maximum understanding.

### Learn at home—no correspondence

This course is so complete, so different—there's no need for the usual letter writing, question and correspondence. You learn in the comfort of your own home, in your spare time... at your own pace. More Than 700 Illustrations \* 688 pp.

#198-H, cloth bound in a single binding, \$11.50

## ELECTRONIC KNOW-HOW

**HOW TO READ SCHEMATIC DIAGRAMS**, by David Mark. Teaching theory and the recognition of symbols, this book is ideal for all those people beginning a career or are starting hobbies in electronics. Covering the symbols and abbreviations used in schematic diagrams related to the electronics field, this book starts with individual components and carries through to receivers and similar equipment. Components and circuits are identified and explained. Soft cover, 160 pp., illus. #208, \$3.50.

**BASICS OF DIGITAL COMPUTERS** by John S. Murphy. Anyone with some knowledge of the fundamentals of electronics can understand and master the basics of electronic digital computers with this new three-volume "picture-book" training course. At least one BIG illustration is given on each page to make the text crystal-clear. Text explains development of computers, basic theory of computer arithmetic, covers circuits, the program, memory, the generation and distribution of timing pulses and control. Written for all who need or desire an understanding of the theory of computers. #196, 3-volume soft cover set, \$6.95; #196-H, cloth bound, \$7.95.

**IMPEDANCE MATCHING** edited by Alexander Schure, Ph.D. The most efficient transfer of energy from one point to another is paramount in every electrical and electronic system. This is the function of impedance matching. This book presents comprehensive coverage of the theoretical as well as practical considerations relating to the delivery of maximum power between any type of generator and the load. To make the book most usable, explanatory numerical examples illustrate the application of equations in the mathematical treatment. Impedance matching devices, their application at audio and radio frequencies and in transistor circuits are covered. #166-23, soft cover, \$2.90.

### FAMOUS 'PICTURE-BOOK' COURSES

**BASIC ELECTRICITY, BASIC ELECTRONICS, BASIC SYNCHROS & SERVOMECHANISMS**, by Van Valkenburgh, Nooger Neville, Inc. — The fabulous picture-text books that teach faster and easier! The theory, principles, and practice of electricity, electronics, and synchros and servos are here presented in a manner that permits a rapid grasp of the fundamentals of these vitally important subjects. Over 2,000 specially prepared illustrations present, explain, and make every topic discussed picture-clear.

Basic Electricity, #169, soft cover, 5 vols., 624 pp., per set \$10.00. #169H, cloth bound in single binding \$11.50.

Basic Electronics, #170, soft cover, 5 vols., 550 pp., per set \$10.00. #170H, cloth bound in single binding \$11.50.

Basic Synchros and Servomechanisms, #180, soft cover, 2 vols., 270 pp., per set \$5.50. #180H, cloth bound in single binding \$6.95.

reduction on Delco 2N278's. A further price reduction is a possibility.

T. A. PREWITT, W9UKT  
Kokomo, Indiana

### SCHEMATICS FOR OLDER SETS

To the Editors:

I have an old model EC-1 Ecophone receiver, for which I am very anxious to obtain a schematic diagram. Can you tell me where I might obtain a copy of the diagram, and any other service information on this particular receiver?

KEVIN WERNER

Albuquerque, New Mexico

We suggest that reader Werner and any other of our readers who have similar requests contact Howard W. Sams & Company, 2201 East 46th Street, Indianapolis 5, Indiana for help along these lines. The company maintains a large file of factory service data covering radios and allied equipment dating back to 1923, and they can usually supply at least a schematic diagram. A charge of fifty cents per page is made to cover photocopy costs. Other sources worth investigating are the older Rider Manuals, some of which are still in jobbers' hands, and Supreme Publications, 1760 Balsam Road, Highland Park, Ill. which has a book of schematics covering the years 1926-1938 as well as manuals for individual years from 1939 through 1942 and 1946 to the present. Not all companies and models are represented but if in doubt, check with the publishers. —Editor.

### SOUND PRESSURE AND LOUDNESS

To the Editors:

Much as I admire G. A. Briggs, and enjoy his articles on audio, I find I must take issue with some statements of his in his article in the February issue of RADIO & TV NEWS.

When Mr. Briggs says "Acoustically, the increase in level caused by an increase in power from 30 to 60 watts is the same as from 1 to 2 watts . . . ." he seems to imply that the subjective increase in the loudness of a tone is the same in both cases. A little earlier in the article, he emphasizes that a 3 db increase in sound pressure produces an increase in loudness "more like 33% than 100%."

I am certain that Mr. Briggs knows a great deal more about loudspeaker design than I, but I am not altogether certain that he completely understands the relationship between sound pressure and loudness. Let me clear up a few points. First, while intensity is a physical measure, loudness is a psychological measure, a dimension of auditory experience, and can only be evaluated subjectively. The unit of loudness generally used by psychologists and acousticians is the "sone" and has been defined as the loudness of a 1000 cps tone, 40 db above the auditory threshold (about .0002 dyne/cm<sup>2</sup>). The sone is a linear measure, that is, a loudness of 10 sones is twice as loud as a loudness



**WE'RE MAKING IT EASIER THAN EVER TO BECOME A WELL PAID  
RADIO-TEL VISIO SERVICE TECHNICIAN**

**NOW - Just \$6 Starts You Training in  
RADIO-TELEVISION  
the SPRAYBERRY "Learn-by-Doing" Way . . .**

**25 BIG, COMPLETE KITS  
of PARTS & EQUIPMENT**

To help you learn *fast* the practical side of Radio-Television, we send you expertly engineered training kits to test and assemble for interesting, valuable shop-bench practice!

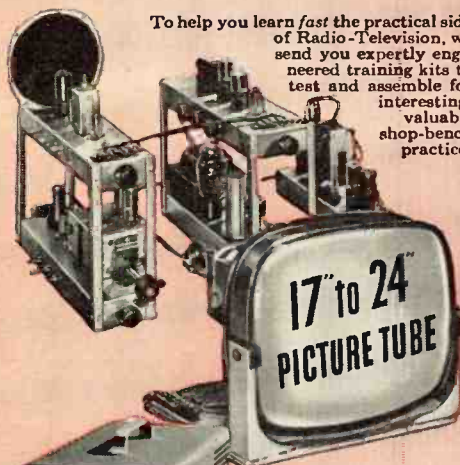

• The new Sprayberry Training Television Receiver, built and tested in 5 sections.

• Now offered . . . this fine modern oscilloscope.

• You build this powerful two-band superheterodyne radio receiver.

**Big New  
CATALOG  
AND  
Sample Lesson  
FREE!**

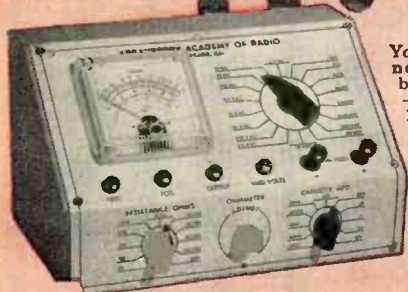
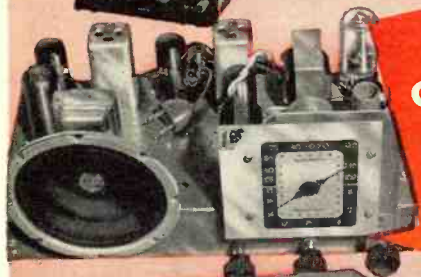

You build the new Sprayberry tester—a complete 18-range Volt-Ohm-Milliammeter test meter.

★ ★ ★ This great industry is begging for trained men . . . to step into good paying jobs or a profitable business of their own! Our new plan opens the doors of Radio-Television wide to every ambitious man who is ready to act at once!

Men by the thousands . . . trained Radio-Television Service Technicians . . . are needed at once! Perhaps you've thought about entering this interesting, top paying field, but lack of ready money held you back. Now—just \$6 enrolls you for America's finest, most up to date home study training in Radio-Television! Unbelievable? No, the explanation is simple! We believe Radio-Television *must* have the additional men it needs as quickly as possible. We are willing to do our part by making Sprayberry Training available for less money down and on easier terms than ever before. This is your big opportunity to get the training you need . . . to step into a fine job or your own Radio-Television Service Business.

**Complete Facts Free—Act Now; Offer Limited**

Only a limited number of students may be accepted on this liberal and unusual basis. We urge you to act at once . . . mail the coupon below and get complete details plus our big new catalog and an actual sample lesson—all free. No obligation . . . no salesman will bother you.

**HOME STUDY TRAINING IN SPARE TIME**

Under world-famous 27-year old Sprayberry Plan, you learn entirely at home in spare time. You keep on with your present job and income. You train as fast or as slowly as you wish. You get valuable kits of parts and equipment for priceless shop-bench practice. And everything you receive, lessons and equipment alike, is all yours to keep.

**LET US PROVE HOW EASILY YOU CAN LEARN!**

Radio-Television needs YOU! And Sprayberry is ready to train you on better, easier terms, than any ambitious man can afford. *Just \$6 starts you!* Mail coupon today . . . let the facts speak for themselves. You have everything to gain. Let us prove the kind of opportunity that's in store for you!

**SPRAYBERRY Academy of Radio-Television**  
1512 Jarvis Avenue, Dept. 25-H, Chicago 26, Illinois

**Mail This Coupon Now—No Salesman Will Call**

**Sprayberry Academy of Radio-Television**  
Dept. 25-H, 1512 W. Jarvis Ave., Chicago 26, Ill.

Please rush all information on your ALL-NEW Radio-Television Training Plan. I understand this does not obligate me and that no salesman will call upon me. Include New Catalog and Sample Lesson FREE.

NAME..... Age.....

ADDRESS.....

CITY..... ZONE..... STATE.....





He who is fortunate enough to own the Garrard 301 Transcription Turntable and the Garrard TPA/10 Tone Arm can enjoy the unique pleasure of knowing that his is the finest . . . the handsomest . . . record-playing combination in the entire high fidelity galaxy.

A pair of great products . . . great because they reflect 35 years of skill and the standards of leadership. No gadgets . . . no compromises . . . only the time-proven features which guarantee continuing, undeviating excellence.

# Garrard

**WORLD'S FINEST  
RECORD PLAYING  
EQUIPMENT**

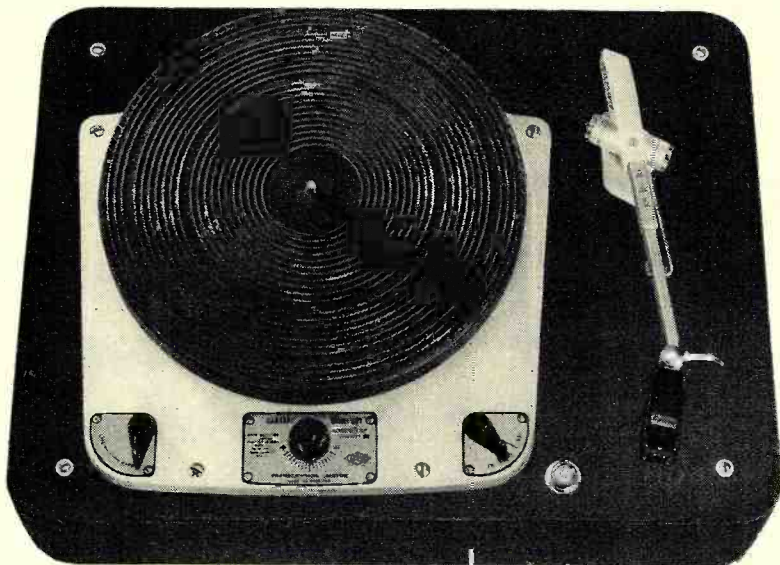

**Model 301  
PROFESSIONAL  
TRANSCRIPTION  
TURNTABLE**

- Features continuously variable control of each speed . . . the record can be "tuned" to match a musical instrument
- Heavy-duty 4-pole shaded motor is entirely Garrard-built
- Cast aluminum turntable is a full 6½ lb. . . . dynamically-balanced
- Motor and connected levers are completely isolated from unit by an exclusive damping system of tension-compression springs
- Exclusive built-in pressure lubrication system
- Performance of each 301 is certified with a written individual test card **\$89.00**

There's a Garrard for every high fidelity system

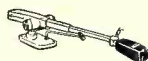

**Model TPA/10  
TRANSCRIPTION  
TONE ARM**

- Built to insure professional quality performance, with traversing and vertical friction reduced to absolute minimum by special cone-type ball-bearing pivots, as in the finest chronometers
- Takes any cartridge
- Fits into more installations than any other professional tone arm, since it is adjustable in length and tracking angle . . . plays up to a full 15" record
- Simple to install, with specially designed templates **\$24.50**



**Model RC88  
4-Speed Super  
Auto-Manual  
Changer  
\$67.50**



**Model RC88  
4-Speed Deluxe  
Auto-Manual  
Changer  
\$54.50**



**Model RC121/II  
4-Speed Intermix  
Auto-Manual  
Changer  
\$42.50**



**Model T Mk II  
4-Speed  
Manual Player  
\$32.50**

For Information Write Dept. GF-48 **GARRARD SALES CORP., Port Washington, N. Y.**

of 5 sones. Through a series of experiments a series of curves showing loudness as a function of intensity and frequency have been obtained and published.

If we examine these curves, we see that for a given intensity of sound, the loudness in the middle of the frequency range is greater than that at either extreme (the Fletcher-Munson effect); and, we see that for uniform logarithmic increases in intensity, loudness increases slowly at first, then more and more rapidly. For a 1000 cps tone, a sound pressure of 80 db produces a loudness of 37 sones; 90 db, a loudness of 48 sones; and, 100 db, a loudness of 80 sones. The difference in loudness between 80 and 90 db is 11 sones. The difference between 90 and 100 db is 32 sones, almost three times as much! Thus, while the ratios between sound pressures may be the same between 30 and 60 watts and between 1 and 2 watts, the loudness ratios may be vastly different. Since we are concerned primarily with loudness and not with sound pressure in our judgement of hi-fi equipment, this point should be made clear. As far as I have been able to determine, popular literature on sound reproduction has either ignored this particular non-linearity of the ear, or has concentrated on the other aspect, the change in the loudness contour with frequency. However, I'm certain a great many of your readers would be interested in knowing why the last few degrees of a volume control may produce a disproportionate increase in loudness.

Since I am shooting at sitting ducks anyway, I might as well fire a few more times. The smallest changes in loudness that can be determined by a good listener range from 6 db (for 1000 cps) at the threshold of hearing to about .5 db at 70 db. These figures can be changed by certain temporal and binaural effects as well as by changing the nature of the stimulation. For complex tones, music for example, the smallest changes in volume that can readily be determined at normal intensity levels are above 1 but below 3 db. In view of these figures, many broadcast step attenuators are calibrated in steps of 2.7 db. So—I take a dim view of Mr. Briggs' statement that an increase of 3 db in sound pressure sounds more like 33% than 100%. If it sounds like anywhere near 33%, I'll eat one of his loudspeaker cones.

L. R. ZEITLIN  
Sound Engineering  
Newton, Mass.

We feel sure that Mr. Briggs knows quite well the difference between loudness and sound pressure since he has elaborated on this subject many times in some of his books. Perhaps the article did not make the distinction and bring up some of the other interesting points mentioned by Mr. Zeitlin.—Editor.



## college grads get ahead faster!

. . . have higher incomes . . . advance more rapidly. Grasp your chance for a better life. Share rewards awaiting college men. Important firms visit campus regularly to employ Tri-State College graduates. Start any quarter. *Approved for Vets.*

### Bachelor of Science degree in 27 months

Complete Radio Engineering courses (TV, UHF, FM, Electronics). Also Mechanical, Civil, Electrical, Chemical, Aeronautical Engineering. *In 36-months a B.S. in Business Administration* (General Business, Accounting, Motor Transport Management). Superior students faster. More professional class hours. Small classes. Enrollment limited. Beautiful campus. Well-equipped labs. Prep courses. Enter June, Sept., Jan., Mar. Earnest capable students (whose time and budget require accelerated courses and modest costs) are invited to write *Jean McCarthy, Dir. Adm., for Catalog and book "Your Career in Engineering and Commerce."*



**TRI-STATE COLLEGE**

1668 College Ave. Angola, Indiana



## 110V, AC POWER SUPPLY FOR 274N RECEIVERS

Just plug it into the rear of your 274-N RECEIVER . . . any model. Complete kit and black metal case, with ALL parts and diagrams. Simple and easy to build wiring changes to be made. Designed especially for the 274-N receiver. **Only \$8.95.** Filament trans. for 274N receivers. Pri. 110V. 60 cy. AC. Sec. 24V. @ .6A. An excellent buy at . . . . . **\$1.95 ea.**

## SPLINED TUNING KNOB FOR 274N RECEIVERS

An exclusive O-R item manufactured for us. Fits BC-453, BC-454 and other 274N receivers. This is a really hard-to-obtain item. **Only .89c ea.**



## OFFENBACH-REIMUS

1564 Market Street, San Francisco, Calif.



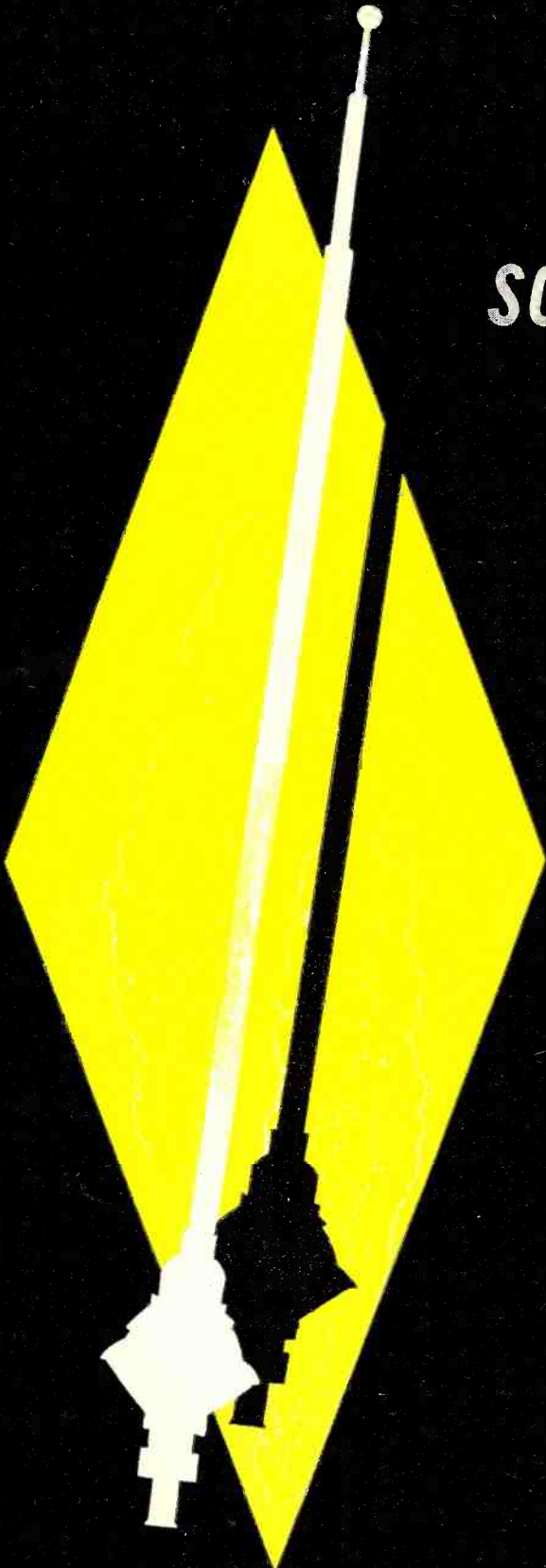

*soon...*

# LOK-MATIC® by WARD

A revolutionary concept  
in auto antenna design.  
See our full page  
announcement in the  
June issue of  
Jobber News and  
Electronic Wholesaling.

watch **w a r d** WARD  
PRODUCTS  
CORP.

1148 Euclid Avenue, Cleveland 15, Ohio  
Division of The Gabriel Company  
In Canada: Atlas Radio Corp., Ltd.,  
50 Wingold Ave., Toronto, Ontario



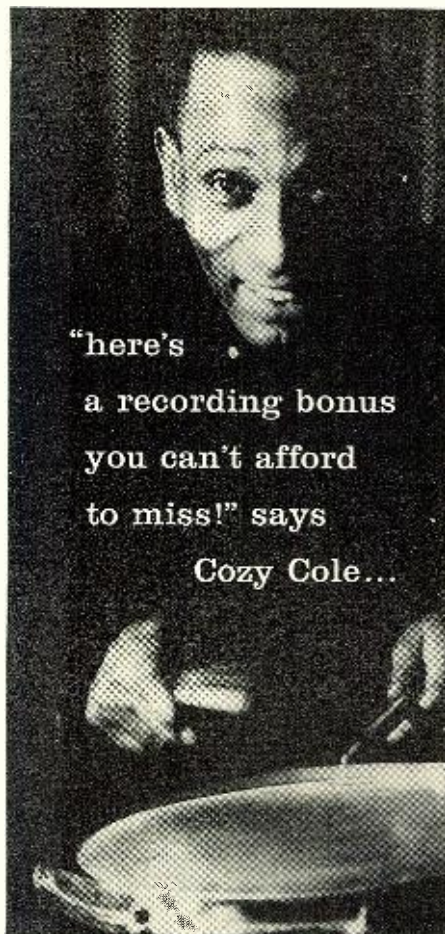

"here's  
a recording bonus  
you can't afford  
to miss!" says  
Cozy Cole...

## SOUNDCRAFT'S 'DIXIELAND JAMFEST IN STEREO'

"is one of the hottest sessions  
I've ever recorded!"

AND IT'S YOURS... RECORDED IN STEREO OR MONAURAL ON ANY 7" REEL OF SOUNDCRAFT TAPE YOU BUY. To demonstrate the superb quality of Soundcraft tapes, you can have this \$11.95 collector's item recording for just the price of the tape plus 75¢ postage and handling! Over 20 minutes of Dixieland Jazz Classics, featuring Cozy and fellow Jazz Greats Coleman Hawkins, J. C. Higginbotham, "Red" Allen, Lou Stein, Sol Yaged and Milt Hinton... an exclusive by Soundcraft... not for sale anywhere at any price! Soundcraft tape is invariably used for recording great artists and great moments in music! Ask about your bonus recording at your Soundcraft dealer today!

ALWAYS BUY SOUNDCRAFT  
... you can't afford not to!



REEVES **SOUNDCRAFT** CORP.  
10 E. 52 St., N.Y. 22 • West Coast: 342 N. La Brea, L.A. 36

# Within the Industry

**DONALD W. GUNN** has been appointed vice-president, sales, of *Sylvania Electronic Tubes*, a division of *Sylvania Electric Products Inc.*



A member of the organization since 1931, Mr. Gunn joined the lighting division in Salem, Mass. In 1936 he became a sales engineer for the company in Chicago and since that date has worked successively as a quality engineer, supervisor of quality control, eastern district sales engineer, east central district sales engineer, and assistant to the general sales manager.

He was appointed equipment sales manager for electronic products in 1951 and division general sales manager in 1953.

\* \* \*

**GEORGE SILBER**, president of *Rek-O-Kut Company*, has been elected chairman of the board of directors of the Institute of High Fidelity Manufacturers, Inc.

Mr. Silber, who was the first president of the Institute, succeeds Avery Fisher, president of *Fisher Radio Corp.* Mr. Fisher, the first board chairman of the association, will continue to serve as a director.

\* \* \*

**SWITCHCRAFT, INC.** has moved to its new home at 5555 N. Elston Avenue, Chicago 30, Illinois... **CGS LABORATORIES, INC.** has transferred its headquarters to Ridgefield, Connecticut. The new location is at the intersection of Routes 7 and 35 on the northern edge of the town... Construction of a permanent plant for the **GENERAL ELECTRIC** computer department has begun in Deer Valley Park, near Phoenix, Arizona. Occupancy is scheduled for January of next year... **AMERICAN GELOSO ELECTRONICS, INC.** has tripled the size of its corporate headquarters. In a new move to the twelfth floor of the building occupied since last May and located at 312 Seventh Avenue, New York, N.Y., the new quarters permit expanded executive and business offices and show rooms... Due to destruction of its plant by fire, **SPAR ENGINEERING & DEVELOPMENT, INC.** has moved from Wyncote to 2829 Philmont Road, Bethayres, Pennsylvania... **SERVOMECHANISMS, INC.** will lease new and larger quarters for its research laboratory in Goleta, California. The building will be leased from the City of Santa Barbara and contains 11,000 square feet... **THE MAGNAVOX COMPANY OF TENNESSEE**, a wholly owned subsidiary of **THE MAGNAVOX COMPANY**, announces an

expansion program for the firm's Greeneville and Jefferson City plants. This expansion will cost in excess of a million dollars and will be completed by July 15... An increased volume of business has necessitated moving to larger quarters for the **BARKER SALES COMPANY**. The firm's new address is 339 South Broad Avenue, Ridgefield, N. J... **IMPACT EXTRUSION PRODUCTS, INC.** has moved to larger quarters at 39 Powerhouse Road, Roslyn Heights, N. Y... A new research and development facility has been set up in the Boston area by **HARVEY-WELLS ELECTRONICS, INC.** of Southbridge, Massachusetts... Operations of the western sales office of **POLYTECHNIC RESEARCH & DEVELOPMENT CO., INC.**, Brooklyn, N. Y., have been discontinued.

\* \* \*

**HELEN STANILAND QUAM**, of *Quam Nichols Company*, has been elected

president of the Association of Electronic Parts & Equipment Manufacturers, Inc. She is the first woman to head a major trade group in this industry.



Mrs. Quam, who is board chairman and distributor sales manager of the firm bearing her name, has been active in trade association work for many years, having served as treasurer of the association for nineteen consecutive years.

Col. Gail S. Carter, *Merit Coil & Transformer Corp.*, was elected first vice-president of the trade association, and Robert E. Svoboda of *Amphenol Electronics Corp.* was chosen second vice-president. Re-elected officers include Kenneth Hathaway, *Ward Leonard Co.*, treasurer, and Kenneth C. Prince, executive secretary.

The association also paid tribute to A. N. (Bud) Haas of *Bud Radio*, first president of the association and last chairman of the informal predecessor organization, as he relinquished his gavel to the newly elected president, Mrs. Quam.

\* \* \*

**RAYTHEON MANUFACTURING COMPANY** has announced that three of its veteran employees have been awarded the Navy Meritorious Public Service citation for outstanding contributions to the Navy in the field of guided missile technology.

Honored for their achievements were T. C. Wisenbaker, assistant manager of the firm's missile systems division; Thomas L. Phillips, manager and chief engineer of the division's Bedford, Mass. laboratory; and Joseph



# THOUSANDS OF E-V STEREO CARTRIDGES

are now in use, accepted as the standard of the industry. Don't buy a new high-fidelity cartridge until you've read this vital stereo report.

## SPECIFICATIONS

RESPONSE: 20-16000 cps.  $\pm 2.5$  db to RIAA  
ELEMENTS: Ceramic  
OUTPUT: (Westrex 1A) .5 volt rms.  
COMPLIANCE:  $2 \times 10^{-6}$  CM/dyne  
TRACKING FORCE: 6 grams  
WEIGHT: 2.4 grams  
STYLUS: .7 mil  
MOUNT: EIA (RETMA). Standard  $\frac{1}{2}$ " and  $\frac{7}{16}$ " centers  
CHANNEL ISOLATION: 20 db

THE MISSING LINK to popular-priced stereophonic sound reproduction has been found: It's the new Electro-Voice TOTALLY COMPATIBLE Stereo Cartridge... plays the new stereo discs superbly... LP's too... even better than existing cartridges.

By breaking the stereo cartridge cost bottleneck, Electro-Voice has made popular-priced quality stereo a reality. E-V's ceramic stereo cartridge (Model 21D with .7 mil diamond stylus) sells for only \$19.50 (Audiophile net) and is available now at your audio dealer or from your serviceman.

## Here are some of the answers to your questions concerning stereo:

**Q** How does the COMPATIBLE E-V Stereo Cartridge differ from CONVENTIONAL cartridges?

**A** It has the ability to play both the new type stereophonic discs and conventional records. Inherent in its design is an improved monaural performance. *Exclusive* design for rumble suppression of 15 db or better will permit the use of Electro-Voice's Stereo Cartridge with any type of changer or transcription player!

**Q** Are stereo discs compatible with conventional cartridges?

**A** Most cartridges damage the stereo record. DO NOT BUY STEREO DISCS UNTIL YOU HAVE AN E-V STEREO CARTRIDGE. You may then play monaural or stereo discs monaurally. Add a second speaker and amplifier, and you have stereophonic sound.

**Q** What about modification problems?

**A** Using an Electro-Voice Stereo Cartridge, which is constructed so that its output is already corrected to the RIAA curve, you will not require the equalization of the *second* amplifier. Inserting the cartridge is simple. It will fit virtually any standard tone or transcription arm. The addition of a second amplifier and speaker is not complicated.

**Q** What about record availability?

**A** Recordings by major record manufacturers will be available in mid-1958.

**Q** What effect will stereo cartridges and records have on your present equipment?

**A** Only your cartridge will be obsolete. All other components are compatible with stereo.

**Q** What if you don't have a HI-FI system now... should you wait?

**A** No. Proceed as before—with one exception: you should insist on a stereo cartridge initially. When you are ready for stereo, merely add a *second* speaker and amplifier.

**Q** How do you go about getting your Electro-Voice Stereo Cartridge?

**A** Visit your dealer. If you don't know the name of your nearest dealer, please write Electro-Voice. Ask for E-V Stereo Model 21 D with .7 mil diamond stylus or E-V Stereo Model 26 DST Turnover with .7 mil diamond Stereo tip and 3 mil sapphire tip for monaural 78 rpm records (\$22.50).

# STEREO IS HERE STEREO

don't buy an obsolete cartridge... replace with the totally compatible Electro-Voice stereo cartridge



## Electro-Voice

ELECTRO-VOICE, INC.  
BUCHANAN, MICHIGAN  
CANADA: E-V of Canada Ltd., 73 Crockford Blvd., Scarboro, Ontario

FOREMOST IN ELECTRO-ACOUSTICS . . .

Microphones, Phono-Cartridges, High-Fidelity Loudspeakers and Enclosures, Public Address Speakers, Marine Instruments, EVI Professional Electronic Instruments and Military Material.





# HERE IS HOW YOU CAN CONVERT TO STEREO...

You can play any monaural source connected to Amplifier "A" through both amplifiers, effectively doubling power output!

Allows you to monitor stereo tape recordings as you make them

You can reverse channels if program material requires

Lets you play stereo from any source

For playing monaural records with your stereo pickup

Play any monaural source connected to Amplifier "B" through both amplifiers

The master volume control adjusts volume level of both amplifiers simultaneously

Provides loudness compensation on both channels, if desired

Master power switch turns on A-C of both amplifiers simultaneously

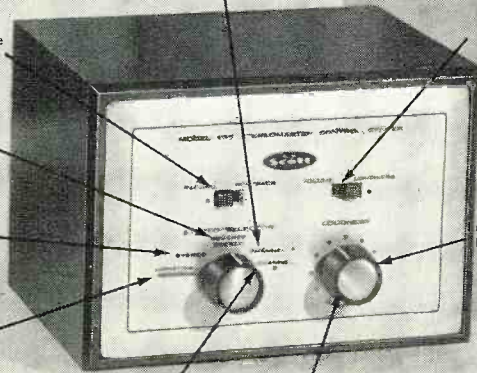

## HERE'S HOW THE STEREO-DAPTOR WORKS

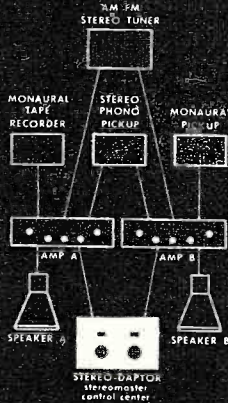

### SPECIFICATIONS

H. H. Scott Stereo-Daptor  
Stereomaster Control Center

Compatibility: Any amplifier in any of the groups shown below may be used with a second amplifier IN THE SAME GROUP for best results with the Stereo-Daptor.

Group I: 99-A, B, C, D; 210-F; 120-A; 120-B; 210-C.

Group II: 121-A, B, C; 210-D, E.

Group III: Any systems with separate preamplifiers and power amplifiers.

Group IV: Two identical complete amplifiers having tape monitoring input and output connections.

Controls: Master Volume: Loudness-Volume: Function Selector (with these positions - Stereo; Reverse Stereo; Monaural Records; Monaural Channel A; Monaural Channel B) Tape Monitor: Power off (on volume control).

Connecting Cables: Four two-foot shielded cables are supplied for all necessary connections. Maximum recommended cable length 3 feet.

Custom Installation: The Stereo-Daptor is easily custom mounted, and no special mounting escutcheons are required.

Price: \$24.95\* completely enclosed. Accessory cases extra

\*slightly higher West of the Rockies

## NEW H. H. SCOTT STEREO-DAPTOR

- Updates your present H. H. Scott System for Stereo records and tape.
- Lets you buy a monaural H. H. Scott System now; convert later.

Just add the Stereo-Daptor and a new H. H. Scott amplifier to your present H. H. Scott system and you can play the new stereo records, stereo tape, stereo AM-FM or stereo from any source.

The Stereo-Daptor permits control of two separate amplifiers from a central point. A Master Volume Control adjusts the volume levels of both channels simultaneously. Special switching lets you play Stereo, Reverse Stereo, use your Stereo Pickup on Monaural Records, or play monaural program material through both amplifiers at the same time. This gives you the full power of both amplifiers. No internal changes are required when used with H. H. Scott amplifiers.

only \$24.95\*

**IMPORTANT! Stereo-Daptor works with All current H. H. Scott amplifiers and most older models . . . with any system having separate pre-amplifier and power amplifier . . . and with complete amplifiers having tape monitor input and output provisions.**

H. H. Scott Inc. 111 Powdermill Road, Maynard, Mass.  
Export: Telesco International Corp., 36 West 40th Street, New York City

Rush me complete information on the New H. H. Scott Stereo-Daptor and your new catalog R-6

NAME.....  
 ADDRESS.....  
 CITY..... STATE.....

H. Leiper, manager of the company's Oxnard, California laboratory.

Wisembaker's citation declared his "imagination, engineering skill, and management ability have aided immeasurably in the Sparrow III weapon system, which has tremendously improved the performance of Navy interceptor armament." Phillips was lauded for his "extraordinary ability . . . for the solution of some of the most formidable problems . . . in practical radar technique and missile guidance systems." Leiper's award cited his contributions in "reliability and serviceability" in creating "greatly improved weapons for the Navy."

**GEORGE S. BOND** has been appointed assistant to the chairman of the board of *Howard W. Sams & Co., Inc.*



Mr. Bond was advertising and sales promotion manager of *P. R. Mallory & Co. Inc.* for the past four years. He joined this firm thirteen years ago as chief engineer, after a tour of duty with the Navy destroyer service as a Lieutenant in World War II.

A graduate of Purdue, Mr. Bond is president of the Central Indiana chapter of the National Industrial Advertising Association and a director of that organization. He is also active in the Association of National Advertisers and is a past member of the American Society for Metals and the American Society for Quality Control.

**HENRY G. SELLERS, JR.** has been appointed assistant director of research of *ORRadio Industries, Inc.* . . . *Xcelite Incorporated* has named **ARCH WARDEN** vice-president. He will also continue his duties as sales manager. **CLARENCE SCHWABEL** has been named secretary-treasurer and **A. J. (ARLIE) HOLMES** is now assistant sales manager . . . *Simpson Electric Company* announces that **J. R. WHITESIDE**, executive vice-president of the firm, has been appointed president . . . **ANTHONY F. ANDERSON** has joined *Sarkes Tarzian, Inc.*, rectifier division, as sales engineer . . . **DR. ROBERT M. BOWIE** has been appointed vice-president of *Sylvania Research Laboratories*, a division of *Sylvania Electric Products Inc.* . . . The board of directors of *Price Electric Corporation* announces the election of **JAMES V. ROUGHAN** as president . . . **ROBERT WECHSLER** has been named advertising, sales promotion, and public relations manager of *American Gelsolo Electronics, Inc.* . . . **HENRY E. BOWES** has been appointed vice-president, marketing, of *Philco Corporation* . . . Three new vice-presidents have been named in the consumer products division of *Hoffman Electronics Corp.* They are: **MARVIN G. WHITNEY**, administrative assistant; **JOHN STEVENS**, director of engineering; and **CHARLES A. NICHOLS**, chief engineer . . . **ROBERT E. SAVOLD** is now field engineer for *Polarad Electronics Corporation* . . . **DONALD C.**



**FREE!**

# ALLIED'S 1958 CATALOG

**404** value-packed PAGES

the only **COMPLETE** catalog for everything in electronics

Get ALLIED'S 1958 Catalog—it's complete, up-to-date—404 pages packed with the world's largest selection of quality electronic equipment at lowest, money-saving prices. Get every buying advantage at ALLIED: fastest shipment, expert personal help, lowest prices, guaranteed satisfaction...

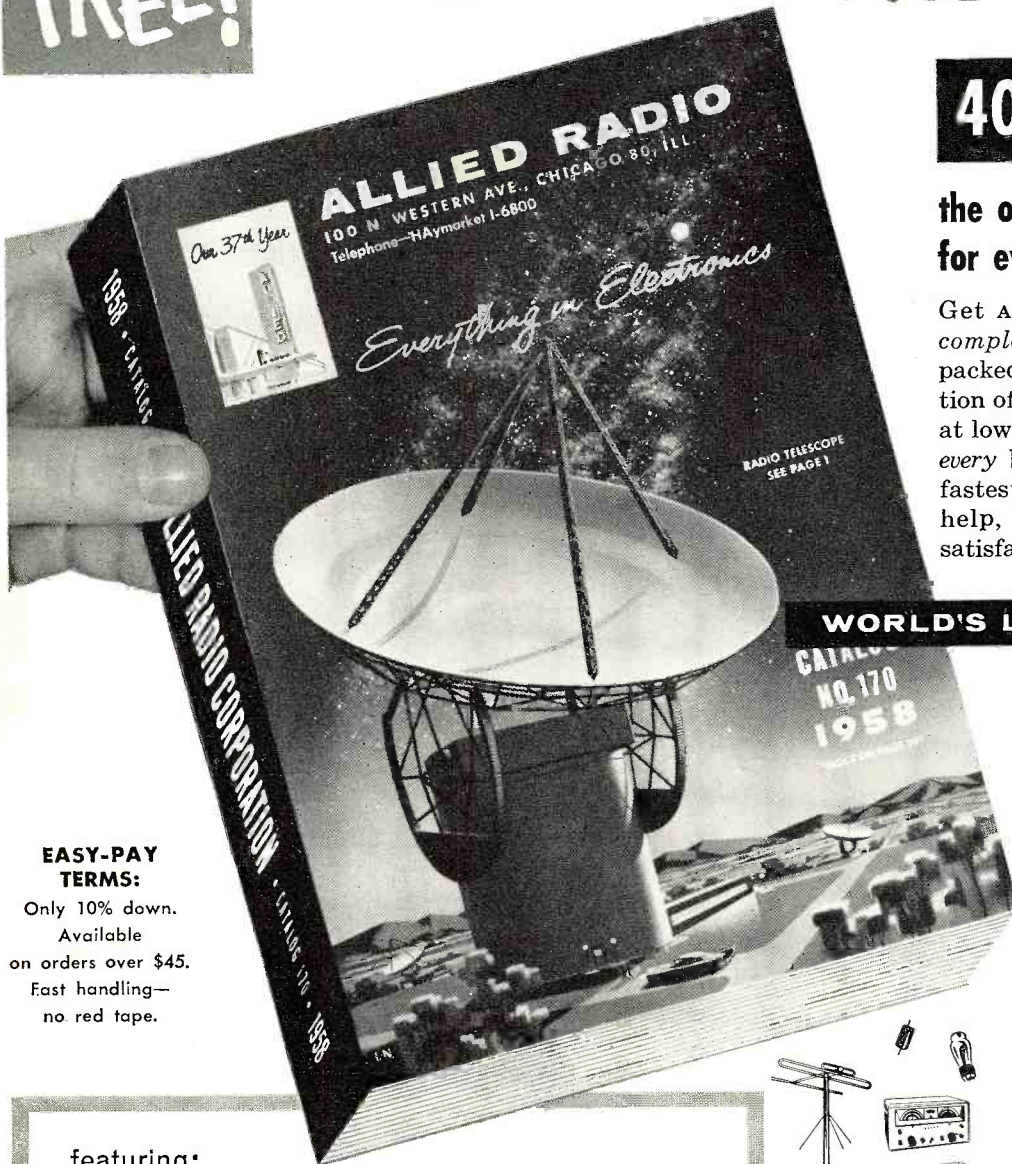

## WORLD'S LARGEST STOCKS

**EASY-PAY TERMS:**  
Only 10% down.  
Available on orders over \$45.  
Fast handling—no red tape.

- Latest Hi-Fi Systems and Components
- Money-Saving, Build-Your-Own KNIGHT-KITS
- Recorders and Supplies
- Public Address Systems and Accessories
- TV Tubes, Antennas and Accessories
- Amateur Receivers, Transmitters, Station Gear
- Test & Lab Instruments
- Specialized Industrial Electronic Equipment
- Huge Listings of Parts, Tubes, Transistors, Tools, Books

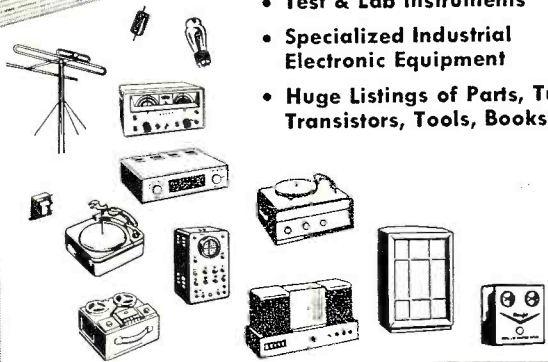

featuring:

### ALLIED'S money-saving knight-kits:

Finest electronic equipment in money-saving kit form. Over 50 quality kits available—Hi-Fi amplifier, tuner and speaker kits, Hobby kits, Test Instruments, and Ham kits. ALLIED KNIGHT-KITS are easiest to build and they SAVE YOU MORE.

### EVERYTHING IN HI-FI

World's largest selection of quality Hi-Fi components and complete music systems—available for immediate shipment from stock. Save on exclusive ALLIED-Recommended complete systems. Own the best in Hi-Fi for less!

send for the leading electronic supply guide

**FREE!**

ALLIED RADIO CORP., Dept. 1-F8  
100 N. Western Ave., Chicago 80, Ill.

Send FREE 404-Page 1958 ALLIED Catalog

Name \_\_\_\_\_

Address \_\_\_\_\_

City \_\_\_\_\_ Zone \_\_\_\_\_ State \_\_\_\_\_



*Our 37th Year*

## ALLIED RADIO

World's Largest Electronic Supply House

June, 1958



# You can rely on QUAM SPEAKERS in every SOUND SYSTEM installation

You get trouble-free operation and excellent sound reproduction with Quam Adjust-a-Cone Public Address Speakers. Their wide frequency response range and heavy rugged construction assure you of complete customer satisfaction.

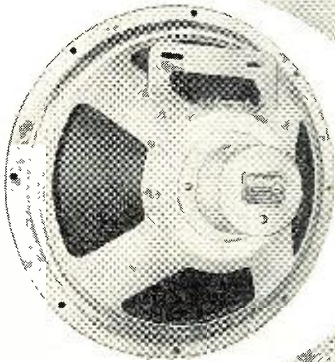

## Quam—and only Quam

Lowest possible flux loss  
Accurate magnet alignment

Precise centering and  
voice coil alignment

Greater heat and humidity  
protection in outdoor  
speakers

— gives you these important benefits:

made possible by the patented U-Shaped Pot

because of the patented Adjust-a-Cone  
Suspension

with the new exclusive Humi-Gard Cone

Over 25 years of engineering "know-how" is built into every Quam speaker. EIA standards are rigidly adhered to, your assurance of top quality and performance.

Write for your free copy of Catalog S-757, describing the complete line of Quam Public Address, Outdoor and Intercom speakers.

*QUAM, the quality line for all your speaker needs*

## QUAM-NICHOLS COMPANY

238 EAST MARQUETTE AVENUE • CHICAGO 37, ILLINOIS

In Canada: A. T. R. Armstrong, Ltd., 700 Weston Road, Toronto 9, Ontario  
D. Eldon McLennan, Ltd., 1624 W. Third Avenue, Vancouver 9, B.C.

### NEW!— HI-FI MUSIC MINDER . . .

automatically shuts off entire hi-fi system after last record has played and turntable stops.

Completely electrical. Simply plug in record changer and hi-fi equipment—the MUSIC MINDER does the rest.

Available at all leading hi-fi shops and parts distributors.

Another first by the leader in quality hi-fi components.



\$7.20 NET



C.B.C. ELECTRONICS CO., INC.  
2601 NORTH HOWARD ST.  
PHILADELPHIA 33, PENNA.

### TREMENDOUS SAVINGS ON PRECISION RESISTORS

Manufactured by leading company. 1% tolerance carbofilm, HiStability, Low temperature co-efficiency. New, Popular Ohmage.

5 lb. assortment of 1/2, 1 and 2 watts . . . . . \$5.00  
10 lb. assortment . . . . . \$9.00

Please include postage with order.

#### UNITED SALES COMPANY

537 State Street Ithaca, New York

DICKSON has joined the semiconductor division of *Motorola Inc.* as product manager for diodes . . . The appointment of **JACK V. BRINER** as district sales engineer for the industrial instrumentation division of *Texas Instruments Inc.* has been announced.

\* \* \*

**ABRAHAM B. COHEN**, well-known sound engineer, has set up an engineering and consulting service at 1325 Rosedale Ave., New York 72, N. Y. He was formerly associated with *University Loudspeakers, Inc.* as engineering manager—a position he held for many years.



He is the author of numerous technical articles on hi-fi and public address as well as of the book, "Hi-Fi Loudspeakers and Enclosures."

He will devote his energies to a study of new and original product designs and the advancement of application methods.

\* \* \*

**VINCENT T. FRUNGILLO** is now the manager of manufacturing cost control, television picture tubes, *Sylvania Electronic Tubes*, a division of *Sylvania Electric Products Inc.* . . . **JOHN E. STOCKTON** has been promoted to the post of supervisor, systems and procedures, in the organization and methods planning office of *Federal Telecommunication Laboratories*, a division of the *International Telephone and Telegraph Corporation* . . . The appointment of **DR. E. M. BALDWIN** as general manager of *Fairchild Semiconductor Corp.* has been announced . . . **ROSS E. HUPP** has been named manager, research and development, *Erie-Pacific Division of Erie Resistor Corporation* . . . **JAMES R. BYRNE** has been elevated to the position of credit manager of *The Hallicrafters Company* . . . **NORMAN CAPLAN** has been appointed manager, communications products dept., telecommunications division, *RCA* . . . *Eitel-McCullough, Inc.* has announced the appointment of **PAUL D. WILLIAMS** to the post of assistant director of research. At the same time, **MYRON C. POGUE** has been named to the newly created post of manager of market research . . . **ALBERT J. HARCHER** has been named works manager at *Clevite Transistor Products*, a division of *Clevite Corporation* . . . The election of **DR. ALFRED H. WILLIAMS** to its board of directors was announced by *International Resistance Company* . . . *Warwick Manufacturing Corp.* announces the appointment of **EDWIN B. HASSLER** as director of engineering, television division, and **JOHN T. RALPH** as director of engineering, radio products division . . . The appointment of **PETER HUMENIUK** as manager, engineering, of *General Electric's* television receiver department has been made known by the firm . . . An indefinite leave of absence from his duties at *Setchell-Carlson, Inc.* has been announced by

(Continued on page 115)





# RCA INSTITUTES



# OFFERS YOU THE FINEST OF HOME STUDY TRAINING

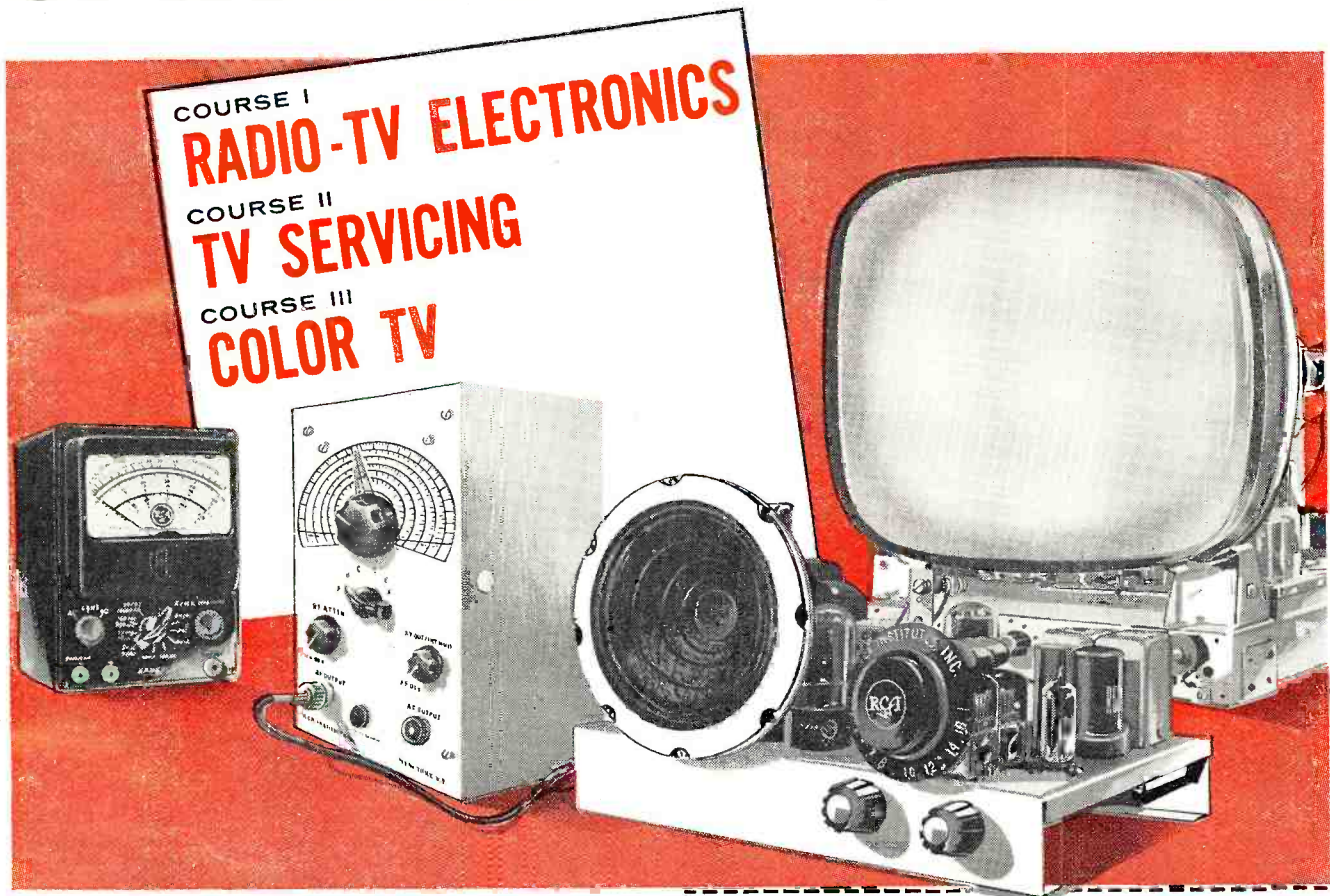

COURSE I  
**RADIO-TV ELECTRONICS**  
 COURSE II  
**TV SERVICING**  
 COURSE III  
**COLOR TV**

The equipment illustrated and text material you get with each course is yours to keep. Practical work with very first lesson. Courses for the beginner and the advanced student. Pay-as-you-learn. You need pay for only one study group at a time.

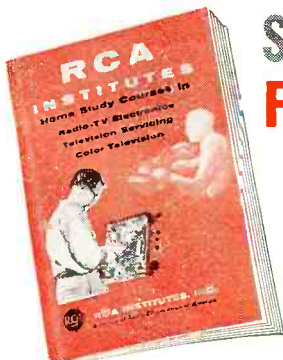

**SEND FOR THIS FREE BOOK NOW**

Resident School courses in New York City offer comprehensive training in Television and Electronics. Day and evening classes start four times each year. Detailed information on request.

**RCA Institutes, Inc.** Home Study Dept. RN-68  
 A Service of Radio Corporation of America  
 350 West Fourth Street, New York 14, N. Y.

Without obligation, send me **FREE** 52 page CATALOG on Home Study Courses in Radio, Television and Color TV. No Salesman will call.

Name.....  
 Please print

Address.....

City..... Zone..... State.....

Korean Vets! Enter discharge date.....

**CANADIANS**—Take advantage of these same RCA courses at no additional cost. No postage, no customs, no delay. Send coupon to:





**RCA VICTOR COMPANY, LTD.**  
 5001 Cote de Liesse Rd., Montreal 9, Que.

To save time, paste coupon on postcard



# University P·S·E

THE ONLY GENUINE PLAN FOR BUILDING A SPEAKER SYSTEM  
EASY ON YOUR BUDGET • NEVER OBSOLETE

 <p><b>Why is P·S·E never obsolete?</b></p>	 <p><b>How can I improve my present system —or add stereo?</b></p>
<p><b>A:</b> Every University speaker component has built-in versatility and flexibility, such as dual impedance and adjustable response woofers . . . speakers that may be used for mid-range and/or treble response . . . adjustable networks. Even our enclosures and kits were designed with P·S·E in mind. All these features guard against obsolescence. And when you start or expand your system with University P·S·E, your original speaker(s) will always be an integral part at every stage... never discarded.</p>	<p><b>A:</b> Very easy with P·S·E. Whatever your present equipment, the variety and flexibility of University's speakers assure compatible integration, while the unique versatility of University crossover networks and filters makes possible almost any number of crossover frequencies and impedances to <i>custom</i>-improve the system you now have. Thus P·S·E is also the smart way to add stereo. If you are starting from scratch, you can budget your stereo speaker system from beginning to end.</p>
 <p><b>How is P·S·E easy on your budget?</b></p>	 <p><b>Why is P·S·E the only genuine plan?</b></p>
<p><b>A:</b> With P·S·E you can start as modestly as you like—with one extended range speaker, for example—and save part of your speaker budget until you've had more listening experience in your own home. Then, as your tastes develop and your budget allows, you can build up in successive, relatively inexpensive steps to a great variety of magnificent speaker systems. You are thus able to devote most of your initial budget to the selection of quality amplifying and program source equipment which cannot be economically altered or substituted later on.</p>	<p><b>A:</b> Because <i>all</i> University speaker components are <i>especially matched</i> and designed with <i>exclusive</i> built-in features that provide the versatility essential to such a plan. Because University makes the <i>world's widest range</i> of quality speaker components—woofers, mid-range, extended range, 2- and 3-way Diffaxials, tweeters, networks—that give you an almost <i>unlimited selection</i> of superb speaker systems to start or develop until you gratify your ultimate aspirations!</p>

## HOW P·S·E WORKS... a typical example



Get this P·S·E booklet at your high fidelity dealer. It lists all the more popular systems you can build the P·S·E way, plus complete specifications on all University speakers, networks, enclosures and enclosure kits. Or write Desk S-4, University Loudspeakers, Inc., 80 South Kensico Ave., White Plains, N. Y.



**STEP 1** Start with the University Diffusicone-8 and realize immediate listening satisfaction.



**STEP 2** Improve the high frequency reproduction to beyond audibility by adding the Model HF-206 Hypersonic Tweeter and N-2B L/C crossover network.

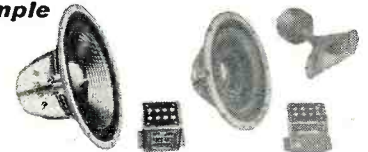

**STEP 3** Reinforce bass response with the Model C-12W Adjustable Response 12" woofer and N-2A L/C network. The Diffusicone-8 now functions as a mid-range speaker. The result . . . the deluxe multi-speaker system you want tomorrow but started today . . . the P·S·E way!

LISTEN

University® sounds better







**Latest Information  
on the Electronic Industry**

*Spot News*

By RADIO & TV NEWS'  
WASHINGTON EDITOR

**STEREO ENTHUSIASM MOUNTS: FIVE RECORD COMPANIES RELEASE DISCS**—A full-fledged swing to stereo on all fronts—discs, cartridges, kits, and even a standardization program—is under way . . . Five independent record companies have announced that they are now shipping stereo discs: Audio Fidelity, Esoteric, Urania, Hallmark, and ABC-Paramount. More, including RCA, have reported that they expect to have stereos available this summer. Some of the records are specifically stereos, while others are compatible for monaural or stereo. In the main, the 45-45 Westrex system has been adopted . . . The engineering committee of the Record Industry Association of America has set up stereo design standards revolving about the 45-45 system.

**\$2.7-BILLION SERVICE INCOME PREDICTED FOR '58**—According to the president of the National Electronic Distributors Association, Joseph DeMambro, an estimated \$2.7-billion will be spent this year for servicing.. The forecast was based on 46-million TV sets now in use, the 95-million home and 35-million auto radios in operation, and the record-breaking 5-million phonographs, including hi-fi and record-playing attachments, that were made last year.

**MICROWAVE DRONE-GUIDANCE SYSTEM DESIGNED TO TEST AIR DEFENSES**—A microwave electronic-guidance system designed to help the Air Force test our defenses against the most modern air weapons available to an enemy has been successfully demonstrated.. The guide, specifically engineered for the Q-4 and 5 supersonic drones, is also being considered as a universal system for controlling other target drones for test purposes, pilotless aircraft, and missiles . . . The system enables a control team anywhere on the ground—or in the air—to track a drone, command its engine and flight controls, and receive flight data.. The drone, equipped with highly transistorized transmitting and receiving equipment, transmits coded information to either the airborne or ground detectors and receives coded commands in return.

**OVER \$50-MILLION AUTHORIZED FOR GUIDED-MISSILE RADAR CONTRACTS**—The Sperry Gyroscope Company has received a contract amounting to nearly \$59-million for the production of radar and missile-guidance radars to be installed in TALOS guided missile ships.. TALOS will form the major armament of the light cruisers "Galveston," "Little Rock," and "Oklahoma City" now being converted into guided-missile cruisers.

**HAMS GET NEW RULES**—The FCC has amended parts 2 (frequency allocations) and 12 (amateur) rules with reference to operations in the 1800-2000 kc. band so as to preclude the use by amateurs of frequencies in the 1875-1925 kc. region after 12:00 Midnight (Eastern Standard Time) on May 10, 1958. The order applies to all ham stations and was issued to permit the expansion of Government-operated Loran radio-navigation facilities on 1900 kc. due to national defense considerations. . . . However, hams may continue to use 1800-1825 and 1975-2000 kc. on a shared basis with Loran.

**AMATEURS TO RECEIVE NEW CALL-SIGN PREFIX**—According to the Commission, when single letter K or W prefixes are no longer available for assignment in a continental call area, such as the second and sixth call areas, two-letter prefixes will be assigned.. The WA prefix will be assigned to all ham stations except stations of Novice class operators.. When practicable, the WN prefix will be assigned to the Novice operators; otherwise the WV prefix will be assigned.

**OPERATING TV STATIONS MOVE UP TO 510**—As we went to press, the FCC announced that 424 v.h.f. TV stations were now on the air and 86 u.h.f. stations were also telecasting; thus bringing the total to 510.. In Utica, New York, the Malco Theatres group was told that its request for a u.h.f. station on channel 54 (710 to 716 mc.) had been approved with a power of 25.7 kw. -50-



# Exciting News From CHANNEL MASTER'S Test Lab!

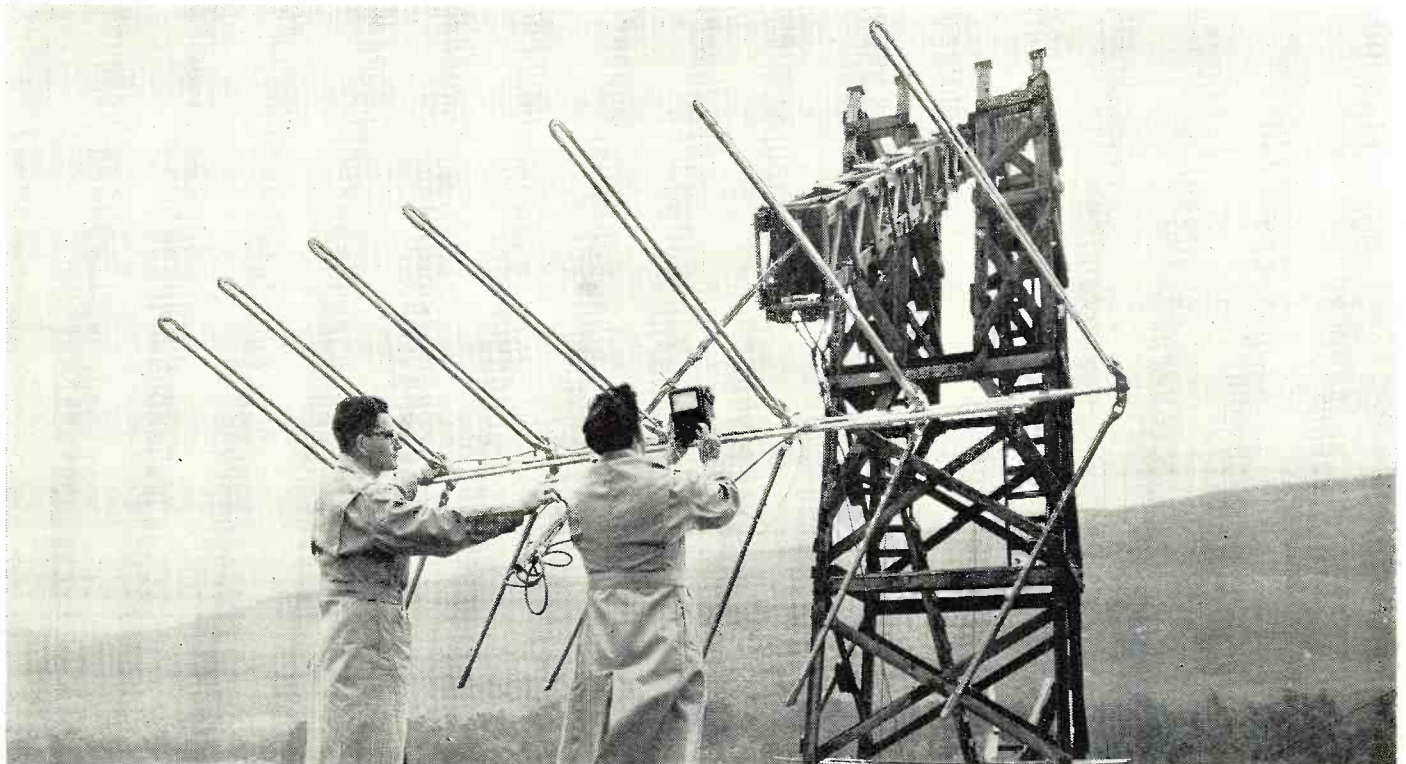

New 350A Series "T-W" Antenna - 7, 5, and 3-element models.

## 5 New Performance And Durability Features Are Built Into The NEW T-W Antenna

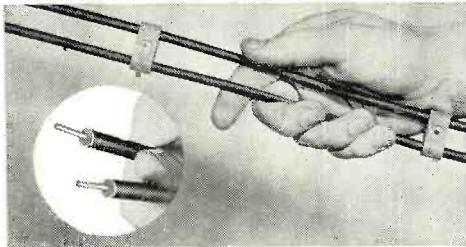

### 1. New Weatherproof Harness Delivers Peak Performance In All Climates

Give your customers the world's most powerful TV antenna performance . . . and never worry about weather problems. The extra-thick 1/4" virgin polyethylene insulation protects impedance match and electrical efficiency against rain, salt, or sea air. 16 gauge copper conductors. Dealers in coastal areas will particularly go for this new T-W feature.

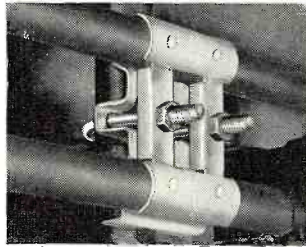

### 2. New Mast Bracket Installs Faster

A few seconds is all it takes with the new single 3/8" U-bolt. New design mast bracket is really rugged, too. 4 rivets through the bracket and mast secure the antenna permanently in place . . . can't ever twist or slip out of position.

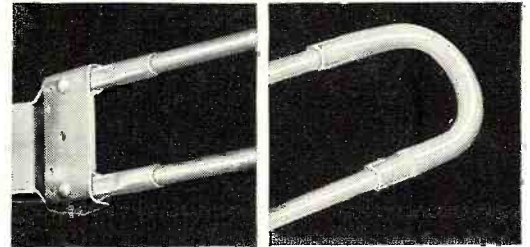

### 3. New Ruggedized Elements Provide Extra Durability

3. Seamless 1/2" diameter external sleeves supply "shock-proof" reinforcement of all elements at the brackets.
4. All dipoles are reinforced at the fold with a seamless 1/2" diameter U-bend.
5. 20% heavier wall thickness on all elements.



**PLUS FAMOUS "TRAVELING WAVE" PERFORMANCE!**  
Highest Gains . . . Highest Front-To-Back Ratios of Any VHF Antenna.

**CHANNEL MASTER CORP.**

ELLENVILLE, N. Y.

The World's Largest Manufacturer of Television Antennas

RADIO & TV NEWS



the experts say... in High Fidelity the best buys are **EICO**<sup>®</sup>

**EICO**  
KITS and WIRED

**BETTER ENGINEERING** Since 1945 EICO has pioneered the concept of test instruments in easy-to-build kit form — has become world-famous for laboratory-precision instruments at low cost. Now EICO is applying its vast experience to the creative engineering of *high fidelity*. Result: high praise from such authorities as Canby of AUDIO, Marshall of AUDIOCRAFT, Holt of HIGH FIDELITY, Faniel of POPULAR ELECTRONICS, Stocklin of RADIO TV NEWS, etc. — as well as from the critical professional engineers in the field.†

**SAVE 50%** Mass purchasing, and a price policy deliberately aimed to encourage mass sales, make this possible.

**EASY INSTRUCTIONS** You need no previous technical or assembly experience to build any EICO kit — the instructions are simple, step-by-step, "beginner-tested."

**DOUBLE 5-WAY GUARANTEE** Both EICO, and your neighborhood distributor, guarantee the parts, instructions, performance... as well as *lifetime* service and calibration at nominal cost... for any EICO kit or wired unit.

**BEFORE YOU BUY, COMPARE** At any of 1200 neighborhood EICO distributors coast to coast, you may examine and listen to any EICO component. Compare *critically* with equipment several times the EICO cost — then you judge. You'll see why the experts recommend EICO, kit or wired, as best buy.

† Thousands of unsolicited testimonials on file.

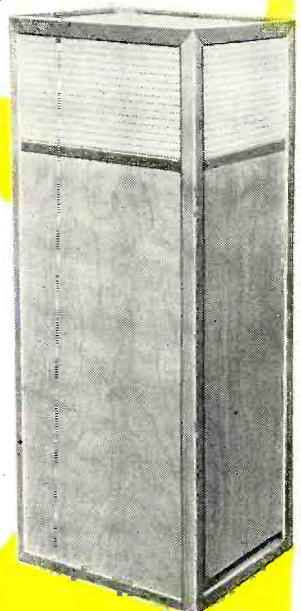

HFS2 Speaker System

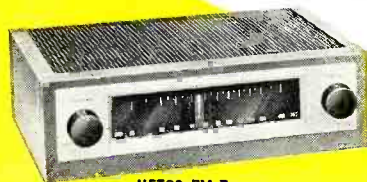

HFT90 FM Tuner with "eye-tronic" tuning



HF61 Preamplifier

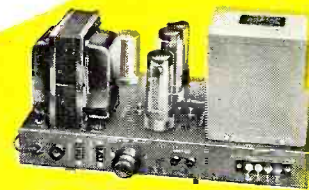

HF60, HF50 Power Amplifiers



**HFS2—Speaker System:** Uniform loading & natural bass 30-200 cps achieved via slot-loaded split conical bass horn of 12-ft path. Middles & lower highs from front side of 8 1/2" cone, edge-damped & stiffened for smooth uncolored response. Suspensionless, distortionless spike-shaped super-tweeter radiates omni-directionally. Flat 45-20,000 cps, useful to 30 cps. 16 ohms. HWD: 36", 15 1/2", 11 1/2". "... rates as excellent... unusually musical... really non-directional" — Canby, AUDIO. "Very impressive" — Marshall (AUDIOCRAFT). Walnut or Mahogany, \$139.95. Blonde, \$144.95.

**HFT90 FM Tuner** equals or surpasses wired tuners up to 3X its cost. New, pre-wired, pre-aligned, temperature-compensated "front end"—drift-free. Sensitivity, 1.5 uv for 20 db quieting is 6X that of other kit tuners. DM-70 traveling tuning eye. Response 20-20,000 cps ± 1 db. Cathode follower & multiplex outputs. Kit \$39.95\*. Wired \$65.95\*. Cover \$3.95. \*Less cover, excise tax incl.

**HF61A Preamplifier**, providing the most complete control & switching facilities, and the finest design, offered in a kit preamplifier, "... rivals the most expensive preamps... is an example of high engineering skill which achieves fine performance with simple means and low cost."—Joseph Marshall, AUDIOCRAFT. HF61A Kit \$24.95. Wired \$37.95. HF61 (with Power Supply) Kit \$29.95. Wired \$44.95.

**HF60 60-Watt Ultra Linear Power Amplifier**, with Acro TO-330 Output Transformer, provides wide bandwidth, virtually absolute stability and flawless transient response. "... is one of the best-performing amplifiers extant; it is obviously an excellent buy." —AUDIOCRAFT Kit Report. Kit \$72.95. Wired \$99.95. Matching Cover E-2 \$4.50.

**HF50 50-Watt Ultra-Linear Power Amplifier** with extremely high quality Chicago Standard Output Transformer. Identical in every other respect to HF60 and same specifications up to 50 watts. Kit \$57.95. Wired \$87.95. Matching Cover E-2 \$4.50.

**HF30 30-Watt Power Amplifier** employs 4-EL84 high power sensitivity output tubes in push-pull parallel, permits Williamson circuit with large feedback & high stability. 2-EZ81 full-wave rectifiers for highly reliable power supply. Unmatched value in medium-power professional amplifiers. Kit \$39.95. Wired \$62.95. Matching Cover E-4 \$3.95.

**HF-32 30-Watt Integrated Amplifier Kit** \$57.95. Wired \$89.95.

**HF52 50-Watt Integrated Amplifier** with complete "front end" facilities and Chicago Standard Output Transformer. Ultra-linear power amplifier essentially identical to HF50. The least expensive means to the highest audio quality resulting from distortion-free high power, virtually absolute stability, flawless transient response and "front end" versatility. Kit \$69.95. Wired \$109.95. Matching Cover E-1 \$4.50.

**HF20 20-Watt Integrated Amplifier**, complete with finest preamp-control facilities, excellent output transformer that handles 34 watts peak power, plus a full Ultra-Linear Williamson power amplifier circuit. Highly praised by purchasers, it is established as the outstanding value in amplifiers of this class. Kit \$49.95. Wired \$79.95. Matching Cover E-1 \$4.50.

Prices 5% higher in the West

**HF12 12-Watt Integrated Amplifier**, absolutely free of "gimmicks", provides complete "front end" facilities & true fidelity performance of such excellence that we can recommend it for any medium-power high fidelity application. Two HF12's are excellent for stereo, each connecting directly to a tape head with no other electronic equipment required. Kit \$34.95. Wired \$57.95.

**HFS1 Two-Way Speaker System**, complete with factory-built cabinet. Jensen 8" woofer, matching Jensen compression-driver exponential horn tweeter. Smooth clean bass; crisp extended highs. 70-12,000 cps ± 6 db. Capacity 25 w. Impedance 8 ohms. HWD: 11" x 23" x 9". Wiring time 15 min. Price \$39.95.

**THE HI-FI EXPERTS SAY:**

"For those who have been looking for a well-engineered yet inexpensive power amplifier, the newly-released EICO Model HF20 unit might offer a simple solution to their problem. Not only does this unit provide 20 watts of power but the circuit incorporates a preamplifier and a variety of controls on a single chassis."

William A. Stocklin, Editor, RADIO TV NEWS

"The new EICO 'standard' speaker system... produces sound that to my musical ears rates as excellent, from high top to clean low bottom."

Edward Tatnall Canby, AUDIO Magazine

Fill out coupon on other side for FREE CATALOG



HF52, HF20 Integrated Amplifiers



HF12 Integrated Amplifier



HF30 Power Amplifier

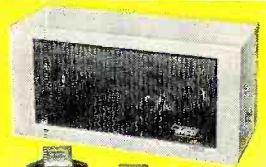

HFS1 Speaker System



33-00 Northern Boulevard, L. I. C. 1, N. Y.  
Over 1 Million EICO instruments in use the world over.



the specs prove it . .  
your BEST BUY is

**EICO**®

for COLOR & Monochrome TV servicing

**FREE CATALOG**

shows you HOW TO SAVE 50%  
on 50 models of top quality  
professional test equipment.  
**MAIL COUPON NOW!**



**NEW!**  
**TV-FM SWEEP  
GENERATOR &  
MARKER #368**  
KIT \$69<sup>95</sup> WIRED \$119<sup>95</sup>

Entirely electronic sweep circuit (no mechanical devices) with accurately-biased inductor for excellent linearity. Extremely flat RF output: new AGC circuit automatically adjusts osc. for max. output on each band with min. ampl. variations. Exceptional tuning accuracy: edge-lit hairlines eliminate parallax. Swept Osc. Range 3-216 mc in 5 fund. bands. Variable Marker Range 2-75 mc in 3 fund. bands; 60-225 mc on harmonic band. 4.5 mc Xtal Marker Osc., xtal supplied. EXT. Marker provision. Sweep Width 0-3 mc lowest max. deviation to 0-30 mc highest max. dev. 2-way blanking. Narrow range phasing. Attenuators: Marker Size, RF Fine, RF Coarse (4-step decade). Cables: output, 'scope horiz., 'scope vertical. Deep-etched satin aluminum panel; rugged grey wrinkle steel cabinet.

**NEW! RF  
SIGNAL GENERATOR  
#324**  
KIT \$26<sup>95</sup> WIRED \$39<sup>95</sup>



150 kc to 435 mc with ONE generator! Better value than generators selling at 2 or 3 times its cost! Ideal for IF-RF alignment, signal tracing & trouble-shooting of TV, FM, AM sets; marker gen.; 400 cps audio testing; lab. work. 6 fund. ranges: 150-400 kc, 400-1200 kc, 1.2-3.5 mc, 3.5-11 mc, 11-37 mc, 37-145 mc; 1 harmonic band 111-435 mc. Freq. accurate to ±1.5%; 6:1 vernier tuning & excellent spread at most important alignment freqs. Etched tuning dial, plexiglass windows, edge-lit hairlines. Colpitts RF osc. directly plate-modulated by K-follower for improved mod. Variable depth of int. mod. 0-50% by 400 cps Colpitts osc. Variable gain ext. amplifier: only 3.0 v needed for 30% mod. Turret-mounted coils slug-tuned for max. accuracy. Fine & Coarse (3-step) RF attenuators. RF output 100,000 uv; AF sine wave output to 10 v. 50-ohm output Z. 5-way jack-top binding posts for AF in/out; coaxial connector & shielded cable for RF out. 12AU7, 12AV7, selenium rectifier; xmfr-operated. Deep-etched satin aluminum panel; rugged grey wrinkle steel cabinet.

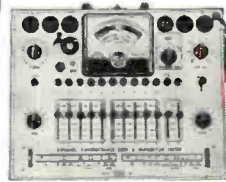

**NEW! DYNAMIC  
CONDUCTANCE  
TUBE & TRANSISTOR  
TESTER #666**  
KIT \$69<sup>95</sup> WIRED \$109<sup>95</sup>

**COMPLETE with steel cover and handle.**

SPEED, ease, unexcelled accuracy & thoroughness. Tests all receiving tubes (and picture tubes with adapter). Composite indication of Gm, Gp & peak emission. Simultaneous sel of any 1 of 4 combinations of 3 plate voltages, 3 screen voltages, 3 ranges of continuously variable grid voltage (with 5% accurate pot). New series-string voltages: for 600, 450, 300 ma types. Sensitive 200 ua meter. 5 ranges meter sensitivity (1% shunts & 5% pot). 10 SIX-position lever switches: freepoint confection of each tube pin. 10 pushbuttons: rapid insert of any tube element in leakage test circuit & speedy sel. of individual sections of multi-section tubes in merit tests. Direct-reading of inter-element leakage in ohms. New gear-driven rollehart. Checks n-p-n & p-n-p transistors: separate meter readings of collector leakage current & Beta using internal dc power supply. Deep-etched satin aluminum panel; rugged grey wrinkle steel cabinet. CRA Adapter \$4.50



**NEW!**  
**COLOR  
and Monochrome  
DC to 5 MC LAB & TV  
5" OSCILLOSCOPE  
#460**  
KIT \$79<sup>95</sup> WIRED \$129<sup>50</sup>

• Features DC Amplifiers!

Flat from DC-4.5 mc, usable to 10 mc. VERT. AMPL.: sens. 25 rms mv/in; input Z 3 megs; direct-coupled & push-pull thruout; K-follower coupling bet. stages; 4-step freq-compensated attenuator up to 1000:1. SWEEP: perfectly linear 10 cps-100 kc (ext. cap. for range to 1 cps); preset TV V & H positions; auto. sync. ampl. & lim. PLUS: direct or cap. coupling; bal. or unbal. inputs; edge-lit engraved lucite graph screen; dimmer; filter; bezel fits std photo equip. High intensity trace CRT. 0.06 usec rise time. Push-pull hor. ampl., flat to 400 kc, sens. 0.6 rms mv/in. Built-in volt. calib. Z-axis mod. Sawtooth & 60 cps outputs. Astig. control. Retrace blanking. Phasing control.



**NEW! PEAK-to-PEAK  
VTVM #232 & UNI-  
PROBE (pat. pend.)**  
KIT \$29<sup>95</sup> WIRED \$49<sup>95</sup>

Half-turn of probe tip selects DC or AC-Ohms.

Uni-Probe - exclusive with EICO - only 1 probe performs all functions!

Latest circuitry, high sensitivity & precision, wide ranges & versatility. Calibration without removing from cabinet. New balanced bridge circuit. High Z input for negligible loading. 4 1/2" meter, can't burn-out circuit. 7 non-skip ranges on every function. 4 functions: ±DC Volts, -DC Volts, AC Volts, Ohms. Uniform 3 to 1 scale ratio for extreme wide-range accuracy. Zero center. One zero-adj. for all functions & ranges. 1% precision ceramic multiplier resistors. Measure directly peak-to-peak voltage of complex & sine waves: 0-4, 14, 42, 140, 420, 1400, 4200. DC/RMS sine volts: 0-1.5, 5, 15, 50, 150, 500, 1500 (up to 30,000 v. with HVP probe & 250 mc with PRF probe). Ohms: 0.2 ohms to 1000 megs. 12AU7, 6AL5, selenium rectifier; xmfr-operated. Deep-etched satin aluminum panel, rugged grey wrinkle steel cabinet.



**5" PUSH-PULL  
OSCILLOSCOPE  
#425**  
KIT \$44.95  
Wired \$79.95



**7" PUSH-PULL  
OSCILLOSCOPE  
#470**  
KIT \$79.95  
Wired \$129.50

**TUBE TESTER  
#625**

KIT \$34.95  
Wired \$49.95  
• tests 600  
mil series  
string type  
tubes  
• illuminated  
roll-chart

Pix Tube Test Adapter ..... \$4.50



**6V & 12V  
Battery Elim  
& Charger  
#1050:**  
KIT \$29.95  
Wired \$38.95

Extra filtered for transistor opt., #1060:  
Kit \$38.95 Wired \$47.95



Sep. hi-gain RF  
& lo-gain audio  
inputs.  
Special noise  
locator. Calibra-  
ted wattmeter.

KIT \$24.95  
Wired \$39.95

**DELUXE MULTI-SIGNAL TRACER #147**

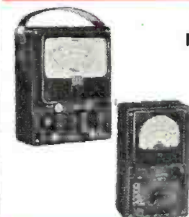

**20,000 Ohms/Volt  
MULTIMETER #565**  
KIT 24.95  
Wired \$29.95

**1000 Ohms/Volt  
MULTIMETER  
#536**  
KIT \$12.90  
Wired \$14.90



Reads 0.5 ohms  
-500 megs, 10  
mmfd-5000 mfd,  
power factor.

KIT \$19.95  
Wired \$29.95

**R-C BRIDGE & R-C-L COMPARATOR  
#950B**



**VTVM PROBES** KIT Wired  
Peak-to-Peak ..... \$4.95 \$6.95  
RF ..... \$3.75 \$4.95  
High Voltage Probe-1 ..... \$6.95  
High Voltage Probe-2 ..... \$4.95

**SCOPE PROBES**  
Demodulator ..... \$3.75 \$5.75  
Direct ..... \$2.75 \$3.95  
Low Capacity ..... \$3.75 \$5.75

EICO, 33-00 Northern Blvd., R-6  
L.I.C. 1, N. Y.

Show me HOW TO SAVE 50% on Test Equipment and Hi-Fi. Send me FREE Catalog and name of neighborhood distributor.

Name.....  
Address.....  
City..... Zone..... State.....

TURN PAGE  
FOR MORE  
EICO VALUES

**EICO**®

Send for  
**FREE CATALOG**  
now

Prices 5% higher on West Coast.

L.I.C. 1, N.Y.



# Outdoor Public Address Systems

By  
NORMAN H. CROWHURST

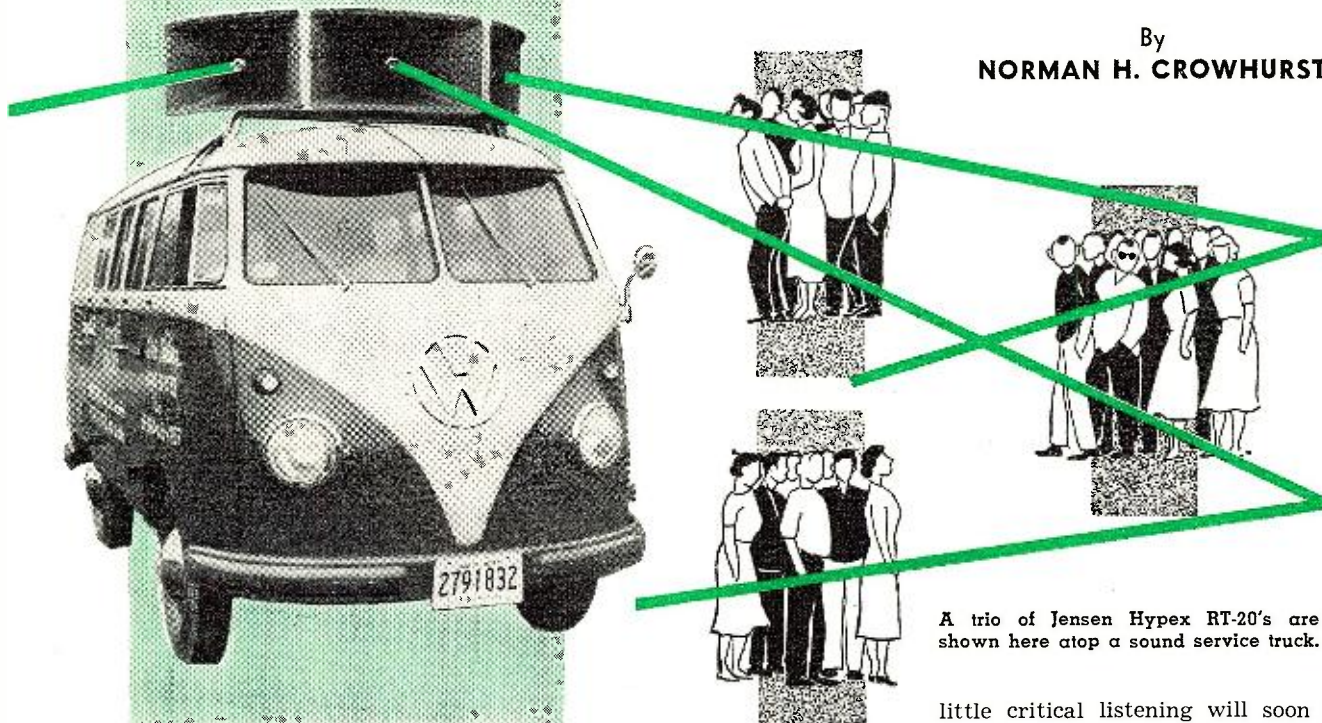

A trio of Jensen Hypex RT-20's are shown here atop a sound service truck.

*Here's some good, practical information for anyone who wants to get into the profitable p.a. field.*

**D**URING the summer months when work in the television and radio department seems to be a bit slow, public address installations can provide a shot-in-the-arm to the service shop. The local county fair, garden parties, open-air dances, an open-air market, or the local stock car races all provide opportunities for the service dealer to keep busy during the normally quiet summer months.

The first problem, of course, is getting a foot in the door. Anyone requiring the services of a public-address "expert" needs assurance that the man knows his business. Confidence is conveyed if you show that you are aware of the requirements of the job and the various contingencies which might arise. Don't ask how many loudspeakers or microphones he'll need—it's your job to tell him! But, before you are in a position to make recommendations there is quite a bit of information you will have to elicit regarding the locale and scope of the project to be handled.

## Microphones

A microphone for broadcasting announcements or any form of voice relay should give good, crisp reproduction without distorting the speaker's natural delivery. Such requirements do not necessarily demand a very

smooth frequency response although a unit with this characteristic will invariably do the job. Often a microphone with a certain amount of "peakiness" in its response will prove quite effective for announcements and voice relay. The important thing here is to check the microphone with one or more typical voices to determine whether or not the mike picks them up with an adequate degree of naturalness.

While a microphone with a certain peakiness in its performance is often adequate if not advantageous for "speech only" purposes, for relaying music from a small orchestra, band, or piano, a microphone with the smoothest possible response is indicated, otherwise the music is apt to sound rather rough or harsh.

Most manufacturers clearly indicate the applications for which their various microphones are best suited but, in the final analysis, a brief trial under working conditions is the truest test. If you want to know which is the best microphone for picking up a piano or small orchestra, the quickest and most definitive test is to obtain the available types, put them alongside one another over the piano or in the orchestra and switch from one to another to see which gives the most pleasing reproduction of the music. A

little critical listening will soon pinpoint the right microphone for the job at hand.

Two other things to consider in selecting a microphone for outdoor use are wind discrimination and the unit's ability to exclude other background noise. Since there is no guarantee on an outdoor job that, when the time comes, there may not be a 15 mph wind blowing, this problem requires forethought. Many microphones are so susceptible to wind noise that the sound they are intended to carry is virtually eliminated.

Wind is not picked up in the manner of ordinary sound. Such pickup is caused by the fact that the microphone housing constitutes an obstacle to the wind the same as telephone wires, trees, and other things that cause a "howl" when the wind blows. A wind above a certain velocity will produce a sound in the microphone housing and, since this sound is close—in fact, inside the microphone itself—it produces a tremendous output, often one that will exclude the desired sound pickup altogether.

Two things must be considered in selecting a microphone for such service. First, the microphone itself should not be overly susceptible to wind noise and, second, if further precaution is necessary to protect it, the effectiveness of the wind preventive measures should be checked.

Sometimes "man-on-the-street" interviewers use a pocket handkerchief to minimize wind pickup just by wrapping it loosely around the microphone so as to divert the air current away from the surface of the microphone it-



Fig. 1. Pole-mounted loudspeakers must be raised above the audience, aimed at rear of area, to get good distribution of the sound.

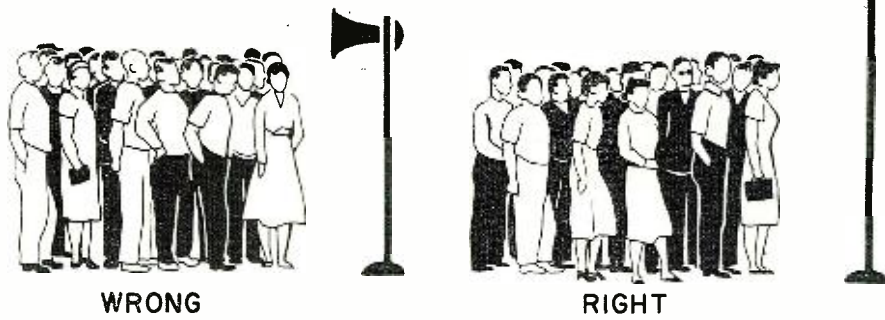

come from a distance while the announcer is speaking "close-up."

### Loudspeakers

Choosing the correct loudspeaker for the job is again dependent on whether it is to be used for voice only or is intended to relay music as well. It is also necessary to provide adequate coverage of the area to be served. This brings us to the matter of choosing a unit which will make maximum utilization of the power amplifier output without wasting any of it in directions where it will do no good.

A plan for a loudspeaker installation can be made using a blueprint of the site but the better technique is to visit the spot for a first-hand "look-see" at the areas to be covered. If possible, try to make such a survey when some activity is scheduled for the area so that you can determine just how much background noise is likely to be encountered.

Often when you ask the organizer of an event whether there will be much extraneous noise to overcome, he will say "It's quite quiet." What he means by this can be almost anything. One surveyor for a public address firm visited a plant where the organizer assured him that the machinery (which was not running at the time) was "quite quiet." On this basis the installation was made and turned out to be totally inadequate. What was "quite quiet" to the man used to the uproar turned out to be loud enough to make it necessary to converse "lip-to-ear."

This probably is the best clue in determining the loudness of the background sound against which the p.a. system must work. Try carrying on a conversation under "normal" conditions. Can you be heard without raising your voice? Do you need to raise it a little? Do you have to shout? Do you need to get close to your listener's ear before he can hear you? These are successive degrees of loudness and will help determine the power and number of loudspeakers needed.

In planning loudspeaker placement, be on the lookout for obstacles. Remember that sound does not feed effectively around corners of buildings or other obstacles. The entire audience area should be in a direct line with some loudspeaker. No space should be obscured by corners that project and cut off the sound.

If possible, try to arrange for adequate coverage of the entire area without blasting some of the audience out of their seats. For example, if loudspeakers are mounted at head level for a standing audience, they will blast into the ears of the people standing directly in front of them while those farther away will have to strain to hear, due to the obstacle effect of other heads.

In a case like this, the loudspeakers should be mounted on tall enough poles so that they can be directed down at the audience. In this way the persons right below the speakers will not be appreciably closer to the sound source

self. This is a moderately effective method and when it happens to be the only one available, serves the purpose.

In some outdoor locations, it may be possible to set up a speaker's booth to protect the microphone from the wind. The only point which must be checked here is that when such an arrangement is employed another type of microphone may be required. The "boxy" tone of the speaker's voice due to the enclosure may dictate the use of a highly directive microphone that will exclude the sound from the box and pick up only the speaker's voice. Often the more directive microphones are sensitive to wind noise but the fact that you are using a booth to exclude the wind means you can now use a directional microphone to make the best of the speaker's voice.

If, for some reason, a booth cannot be used, a simple general-purpose dynamic microphone (with a wind shield, if necessary) may be the best bet. The best way to determine suitability is, of course, to test out a group of microphones by operating them on a windy day.

Noise rejection isn't often a required characteristic of a microphone but when it is, the use of an appropriate type, such as a second-order differential or gradient microphone, can often save the situation. For example, if the announcer's location happens to be adjacent to the kitchen area of a garden party where the clashing of crockery could easily drown out the speaker's voice, a noise rejection microphone will exclude these extraneous noises because they

Fig. 2. A typical outdoor sound distribution problem is shown here. The basic figures are shown at top, while the final details are shown below.

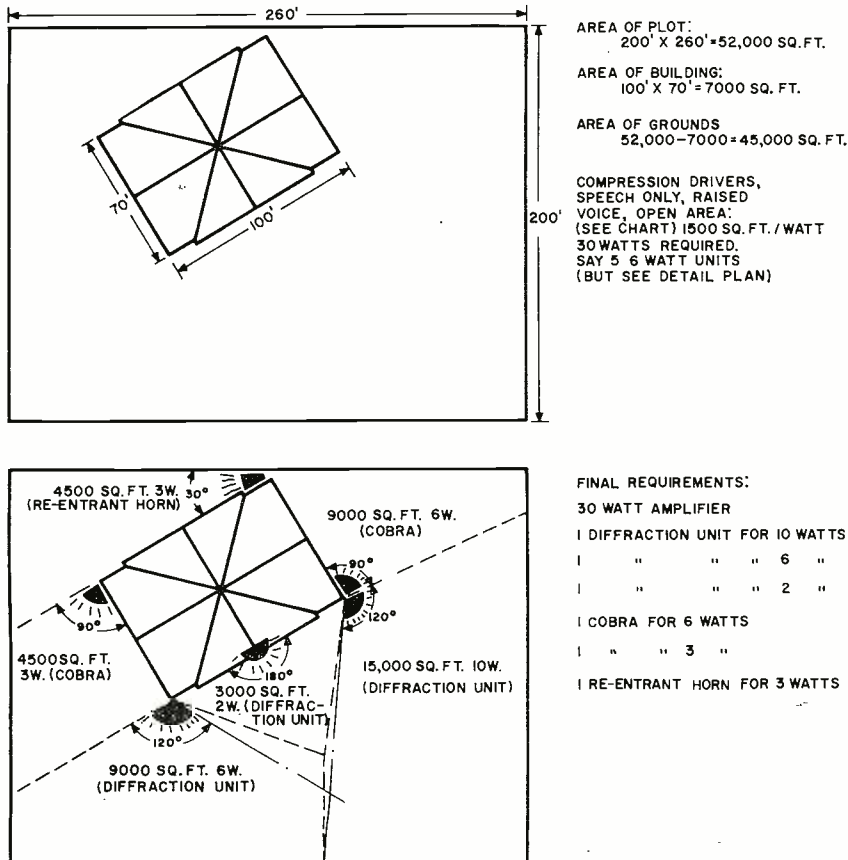



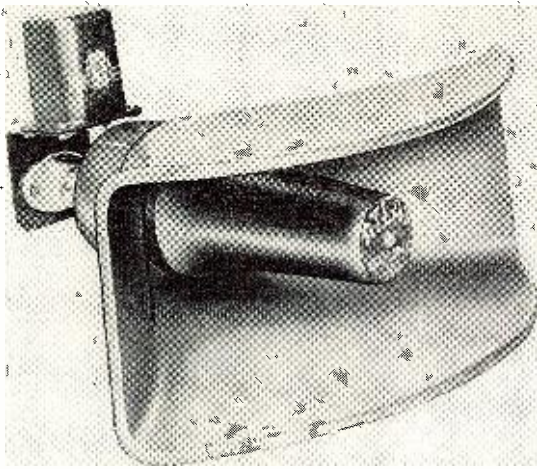

Shown here is the Atlas Cobra-Jector Model CJ-30 public-address system loudspeaker unit along with its transformer.

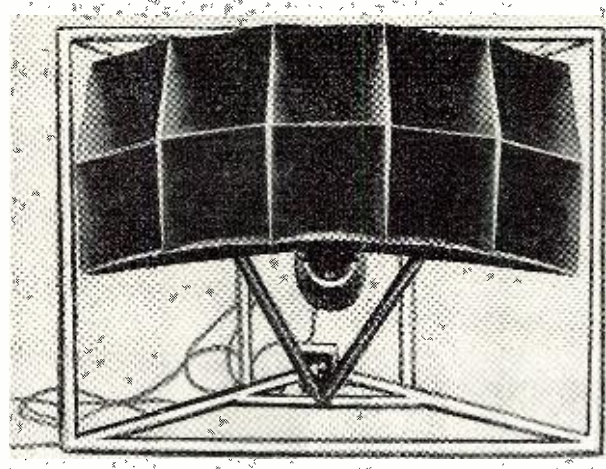

An example of a multi-cellular horn driven by a compression driver. Unit shown is Altec 290C HF driver and H-1003 horn.

than the rest of the audience. The fact that the loudspeaker is directly toward the people farther away will tend to equalize the intensity over the entire listening area despite a slightly more indirect reception by the people standing immediately beneath the installation. See Fig. 1.

### Speaker Horns

When you have a clear picture of where you intend to put the speakers and the area they have to serve, you will be in a better position to choose the right loudspeaker for the job. If the area to be served by each unit represents a fairly narrow angle from the loudspeaker location, the straight or re-entrant type horns are probably the best. Such units produce a radiation in a comparatively narrow angle. If a wider angle is needed, several such horns may be used together.

All of these units, by the way, are especially adapted for speech but, if they are of the larger type, they can be used for music as well.

For a more accurate control of the areas served, the multi-cellular type can be useful for the high-frequency end of the speech spectrum. If the system is to be used on music as well, such horns will need to be supplemented by the large outdoor bass horn type.

A very useful unit for wider angle radiation is the two-way or diffraction horn which is of the re-entrant type for the lower frequencies with a direct horn for the higher frequencies. However, the horn shaping of both units is different from the ones mentioned earlier and this makes all the difference in the shape of the radiation pattern. Such a horn produces a radiation pattern over an angle approaching 180 degrees in the horizontal plane. This can be useful in a number of applications.

There is one more type that is especially suited to outdoor applications—the 360-degree radiator. In large areas where the crowd is fluid, these horns can be mounted as a bell (inverted or right side up) on suitable

TYPE OF PROJECTOR	HORIZONTAL ANGLE (in degrees)	VERTICAL ANGLE (in degrees)
Round re-entrant horn	30 to 100	30 to 100
Straight horn (round)	30 to 75	30 to 75
With above units, size governs the low-frequency limit, usually specified in the catalogue.		
Multi-cellular	Can be tailored to needs by arrangement of cells	
Large box horn	Not particularly directional	
Two-way (incl. diffraction type)	120 to 180	60 to 90
Rectangular re-entrant (incl. cobra-type)	80 to 120	40 to 60
360-degree radiator	360	60 to 90

The efficiency of the unit in converting electrical power into sound delivered to the above areas depends on the design of the unit, whether a compression driver or cone unit is used. See Table 2 for details on efficiency of coverage.

Table 1. The sound distribution provided by different loudspeaker types. The figures are subject to wide variations. It is suggested that manufacturers' specifications be checked for the particular speaker unit that is to be used.

Table 2. Square foot area coverage that is provided per each amplifier watt.

LOUDSPEAKER Program type	COMPRESSION DRIVERS <sup>1</sup>		CONES WITH FLARES <sup>2</sup>		
	Speech & music		Speech only	Speech & music	
	Walled	Open	Walled	Open	Walled
Audience area <sup>3</sup>					
Loudness measure <sup>4</sup>					
Normal speaking	15,000	5,000	1,500	500	
Raised voice	5,000	1,500	500	150	
Shouting	1,500	500	150	50	
Close shouting	500	150	50	15	

- Notes: 1. Compression drivers are the high-pressure type units, used with any kind of horn or bell projection unit that gives well-utilized distribution of sound.  
 2. Cones with flares are small cone-type loudspeaker units mounted in a horn-type flare projection unit of some kind.  
 3. The use of a walled audience area restricts flow of sound outside the area and also helps to keep out extraneous sound.  
 4. The loudness measure lists the level at which one would have to speak to a neighbor in the audience area to be heard.

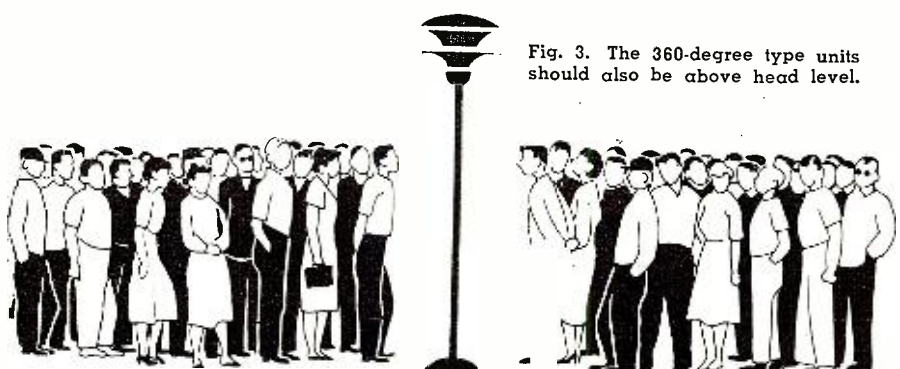
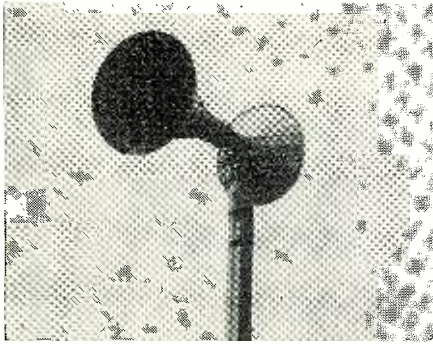

Fig. 3. The 360-degree type units should also be above head level.





A special pole-mounted speaker used for air-raid warning. This Racon installation uses a 6-foot straight horn with a dispersion of 40°. Eight driver units, able to handle 300 watts of audio, feed the horn.

pedestals. They radiate sound in a horizontal plane through an angle of 360 degrees without wasting energy into the air above.

Of course, the mounting for this kind of loudspeaker must be such that it places it above the heads of the crowd to prevent blasting or dead spots. Mounting such speakers on ten or fifteen foot poles is usually adequate because those nearby get an indirect sound while those farther away get more direct radiation. See Fig. 3.

We have not discussed the use of cabinet-type loudspeakers for outdoor applications because, in general, they are much less efficient than horns and it is usually important to utilize every bit of the sound produced by the amplifier.

### Power Needs

The accompanying charts (Tables 1 and 2) will help in selecting loudspeakers and finding out how many are required to cover the area, always keeping in mind that the manufacturers' ratings should not be exceeded.

If awkward corners require additional speakers for adequate coverage, it may be possible to operate these speakers at less than their maximum level since the area is smaller than the units are designed to serve. This may entail the use of a few extra units to provide uniform coverage. See Fig. 2.

This kind of adjustment can be accomplished by the use of a 70-volt line and suitable matching transformers with the speakers. Several of the loudspeaker manufacturers now offer

multiple matching transformers which permit the speakers to operate from the 70-volt line. Different taps enable the speaker to be set to draw 1, 2, 3, or 5 watts, for example, or a higher power transformer may provide for 2.5, 5, 7.5, or 10 watts, and so on. This makes for flexibility in a large installation where four or more speakers are required. The method of reckoning is quite simple. Just add the values according to the speaker taps used to arrive at the total power needed. This is the wattage rating of the amplifier required. Of course it is necessary to use amplifiers with 70-volt outputs.

Most local p.a. jobs can be covered quite adequately with a 30-watt or, at most, a 60-watt amplifier. Some of the bigger jobs—stock car racing meets, for example—may require much higher wattages to handle the job. It may be possible to borrow "matching" amplifiers from friends operating in other areas—on a reciprocal basis, of course.

### Operation

Each amplifier should work into its own section of the loudspeaker load, with the input for the auxiliary amplifiers attenuated from the output of the main amplifier. Most amplifiers have provision for a high-level input from a radio tuner or crystal pickup. This is suitable for connecting in from the main amplifier's output using the 4-ohm, or lowest available, output tap on the main amplifier. See Fig. 4.

The gain controls on the auxiliary amplifiers can be used to balance the levels from the individual loudspeaker groups. If no gain control is provided for this purpose, it is possible to make up a separate circuit, consisting of a fairly low resistance gain control with connecting leads, to go to the low-impedance output of the main amplifier and the high-level input of the auxiliary amplifier.

For good outdoor public address work the amplifier should include provision for a 70-volt line as such facilities are almost a necessity where distances are involved. The amplifier should also have both microphone and high-level inputs.

Plus features for an amplifier used for p.a. work include some provision for tone control, bass boost and cut, and treble boost and cut. If the sys-

tem is being used exclusively for speech, the bass should be cut down to give greater intelligibility. Sometimes it is also advantageous to boost the treble. For relaying music the balance should be set to give the most pleasant reproduction over the system.

For outdoor installations it is always advisable to use an amplifier with a power transformer rather than an a.c.-d.c. type. This enables ground to be isolated from the supply. It is advisable, even if not compulsory in your locality, to make a good ground connection on any outdoor system. This reduces the shock hazard and may save you a costly liability defense. A 70-volt line with audio can, of course, deliver a hefty jolt—even if it is not likely to be fatal. Failure to operate with the circuit properly grounded could cause you unnecessary trouble, so why take the chance.

### Wiring

The only aspect of public address installation that still needs to be covered is the mechanical details.

Wiring for an outdoor installation should, of course, be waterproof and the equipment protected. It should also be installed in such a way that it does not constitute a hazard to the audience. Cables running on the ground can cause nasty falls and if it is impractical to bury the wires, they should be covered in a suitable manner. Cables can be run overhead, but they should be installed high enough to clear the tallest person. It is no excuse to say that the cable was visible, therefore the person should have ducked. Safety precautions are your responsibility—not the crowd's.

Care of this kind also pays off in another way. It avoids the embarrassment of a system breakdown due to a prankster with wire cutters.

If the 70-volt outputs are used, heavy current carrying capacity is not required. Any suitable wire, preferably with the insulation color coded (e.g., black and red) to aid in phasing, that is weatherproof, and physically tough enough should serve. In some areas there may be local regulations governing the kinds of cable that may be used so it is wise to check with your city's Dept. of Electricity first.

Finally, a brief word about p.a. system maintenance. The audience doesn't want to be aware of the sound sources. This means that your equipment shouldn't break down at inauspicious moments, necessitating flurried and embarrassing "public" repairs.

If you provide a good installation, the audience will not be aware of it—but a poor installation will give you a professional "black eye." Good public address is unlikely to be noticed by anyone except another p.a. man. He may realize you've done a good job, but the average member of the audience shouldn't be conscious that you've done any job at all—he should just hear what he is supposed to hear—the program—not the p.a.! —[30]

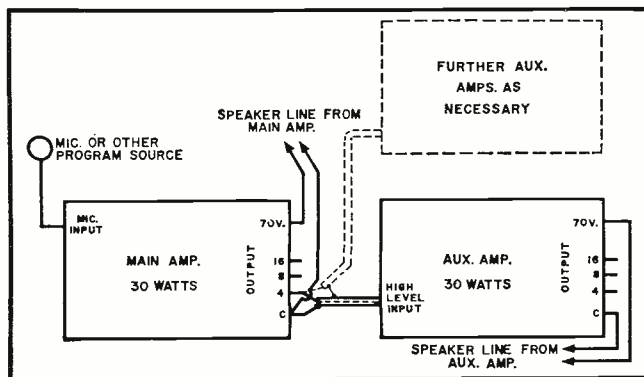
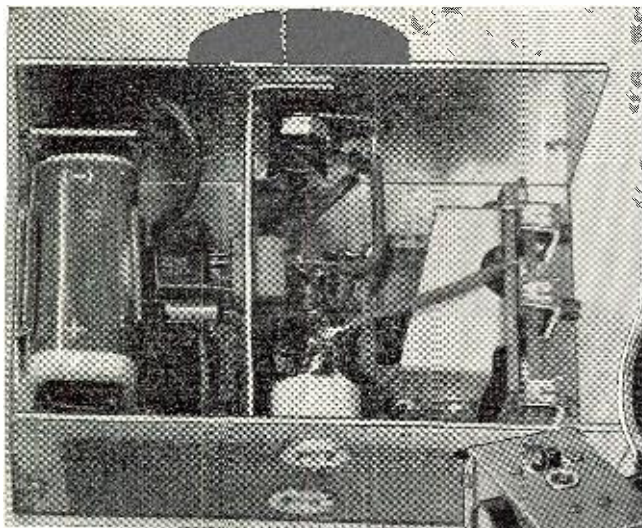

Fig. 4. How to use standard 30- or 60-watt p.a. amplifier units for installations needing more power than a single amplifier will provide.



By R. L. WINKLEPLECK



Trigger unit with Argus flash gun plugged into crystal socket (see inside view). A standard flash gun outlet is mounted beside the switch.

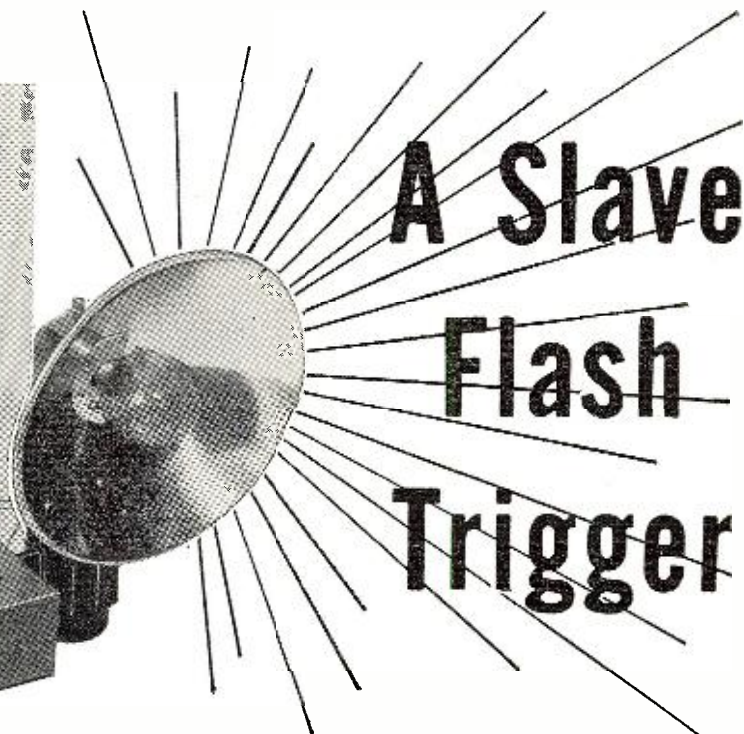

# A Slave Flash Trigger

*Use one of your extra flash guns as a slave unit, fired by this shirt-pocket-size light trigger.*

**A**LMOST every camera sold today is a flash camera. Flash bulbs are being sold in volumes never even dreamed of a few years ago. The next step for many photographers is multiple flash. This usually means a wired extension flash unit, but tangled cords are discouraging and interest soon focuses on a light-actuated slave flash outfit.

Commercial units are often expensive, bulky, and heavy. They're demanding of both "A" and "B" batteries and are sometimes temperamental.

Here's a real improvement. It's not a full-fledged "slave" but only the trigger. One of your extra flash guns acts as the slave flash, its personality

changed by this shirt-pocket size "light trigger."

Small size, extreme sensitivity, fast response, and complete dependability are all achieved by using some of the newer components. The light-sensing unit is a brand new silicon solar cell just introduced by *International Rectifier*. High-gain transistors form a d.c. amplifier with power to spare and the relay is one of those small, sensitive *Advance* units. The power comes from a single 15-volt hearing-aid battery which can provide a lot of service and still last out its shelf life.

A *p-n-p* and an *n-p-n* transistor are joined in a complementary-symmetry d.c. amplifier. The transistors' zero

signal currents *buck* each other; so, there's very little dark current through the relay coil. Under conditions of low room illumination, the output of the silicon cell is only a couple of microamperes and the 150X amplifier gain produces about .3 milliampere flow through the relay coil. The bright burst of light from a flash bulb, however, may increase cell output to over 100  $\mu$ a. with a resultant 15 ma. amplifier output—far more than the minimum required to dependably actuate the relay. It is, therefore, easily possible to adjust the relay so that it will not respond to room lights but will promptly trip from a flash. Incidentally, the response time of the silicon cell, the transistor amplifier, and the relay is so short that an "SF" or "SM" bulb in the slave will peak with, or even before, the peak of an "M" type bulb on the camera which initiates the action.

The unit pictured is assembled in a  $3\frac{1}{4} \times 2\frac{1}{8} \times 1\frac{1}{8}$ " "Minibox." The two outlets on the box fit the flash guns of the author's color and black-and-white cameras; so, it's possible to use either gun as a slave and the only additional equipment needed—to have the advantage of multiple flash—is the small "trigger" which occupies no more space in the gadget bag than a couple of flash bulbs.

For the photographer who wants a complete slave flash gun, an alternate circuit is offered which consists of the original components plus a capacitor and resistor. The flash socket and reflector are attached to the box in place of the flash contacts. This incorporates the popular B-C flashing circuit which is now so widely used. The flash bulb itself replaces the switch. When a bulb is placed in the socket, the unit is turned on; and, when it is flashed, the unit is automatically turned off.

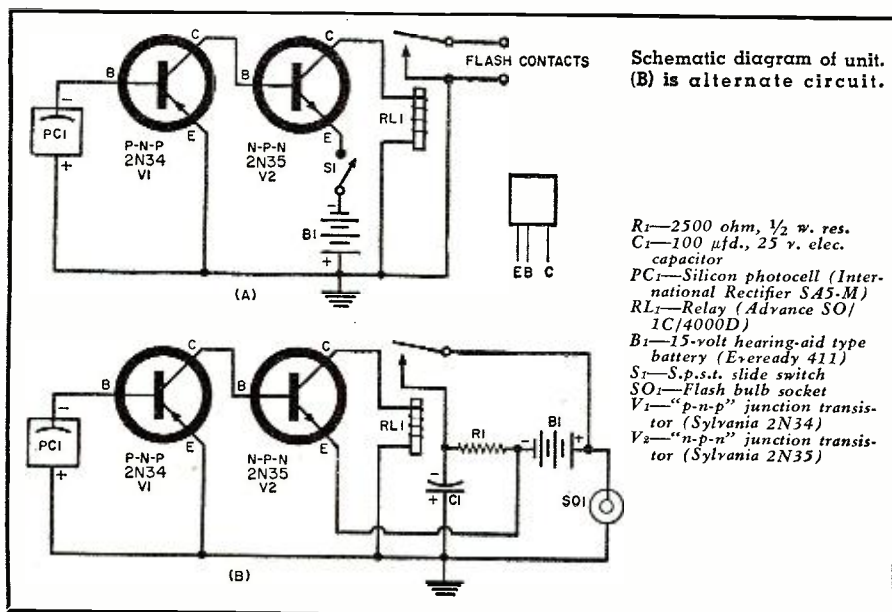



# System Maintenance

## in Two-Way Mobile

Final adjustment of a two-way unit is made when it is re-installed, since the antenna is involved. The transmitter section is on the left, the receiver is to the right, and the power supply is located between them.

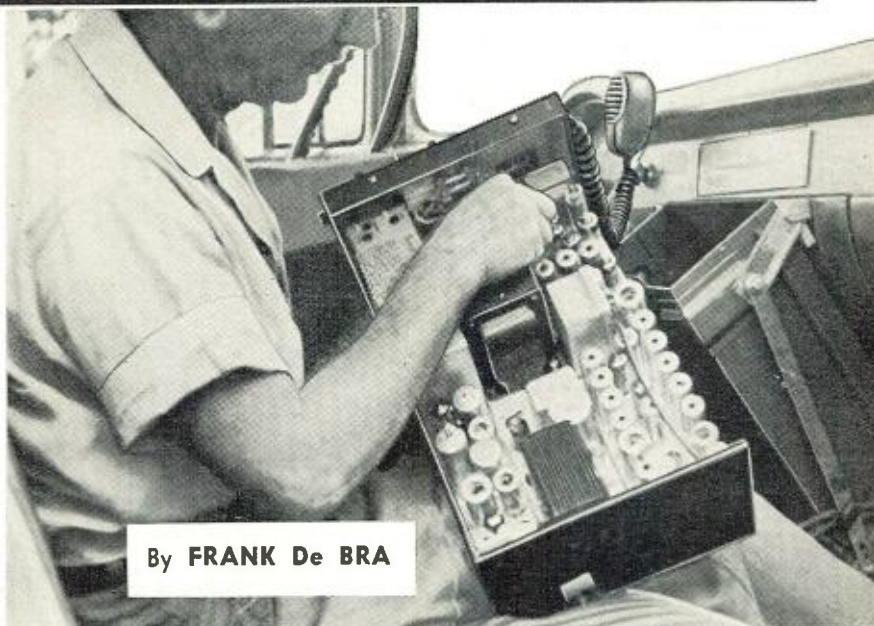

By FRANK De BRA

*Emphasis is on preventing rather than correcting faults: systematic, regular checks are mandatory.*

**M**OBILE-RADIO communications equipment must operate dependably and efficiently day in and day out. However, no communications system can be better than the maintenance given it. Therefore, this maintenance must be thorough and efficient. In order to attain this goal, a systematic maintenance procedure must be developed.

It is true that most communications equipment will operate for long periods of time completely unattended. But, it is equally true that the efficiency and dependability of a communications system falls off with the passing of time. Tubes age and weaken, connections become loose and broken, fuses become fatigued—many things happen to decrease the efficiency of the system. A systematic maintenance procedure, properly set up and carried out, will ensure continued and efficient operation.

Maintenance should start even before the equipment is installed. Receivers should be checked for proper frequency, sensitivity, squelch action, and audio. Transmitters should be checked for frequency, deviation, and power output. Both the transmitter and its receivers should be "netted" before they are installed; i.e., units in the same network or system should be adjusted or aligned to each other. Relays, switches, and plugs all should be checked for proper operation.

For setting up maintenance procedures, an installation may be divided into four parts:

1. The primary power supply. This covers the fuses, cables, and switches up to the power supply in an a.c.-operated installation. In a mobile installation it covers the battery, the generator, the voltage regulator, the fuse, any relays, and the wiring and cable up to the unit itself.

2. Cables. This covers all wires and cables exterior to the unit and separate from the primary power supply. It also includes the antenna and lead-in. In a base station, it also includes all remote-control wiring.

3. The radio unit. This covers the receiver and the transmitter, and the power supply for both, whether they are separate or all one unit.

4. Accessories. This covers anything not already covered: loudspeakers, microphones, remote-control units, and so on. Here is a system-maintenance check list that should be helpful.

Primary power supply: Normally it is not the responsibility of the service organization to maintain the battery, generator, voltage regulator, and associated wiring. However, it is to your advantage to check the entire supply in order to ensure that the radio will be properly supplied with power. Things to look for include:

Battery: Check the connections. Clean, tighten, or replace as required. Clean the top of the battery. Make sure the cell caps are in good condition and the vent holes are clear. Check the water level in each cell, adding water if necessary. Check the battery cables. Make sure the battery

is mechanically secure in its mounting.

Generator: With a voltmeter, check for proper output, no-load and full-load. Check the condition and cleanliness of the brushes and the armature. Check, clean, and tighten the connections. Lubricate if necessary. Make sure the drive belt is in good condition and under proper tension. Check the condition of the connecting wires.

Voltage regulator: Check for proper operation. Check, clean, and tighten all connections. Check the condition of the wiring.

If you find something wrong with these components, and it is not your responsibility to maintain them, contact the proper person and explain that the radio cannot function properly because of faults in these components. Request that proper action be taken.

In an a.c.-operated unit, there is very little trouble encountered in the primary power supply. However, a.c. voltages can be consistently too high or too low, or can vary from too high to too low. Keep a check on this. It might be necessary to install a voltage regulator.

Fuses and fuse holders: Check the voltage drop across the fuse under full load. If it exceeds 0.1 volt, there is a high-resistance connection or a dirty fuse holder, or the fuse itself could be faulty. Check, clean, and tighten the connections. Clean the fuse holder and fuse caps. Burnish with fine sandpaper. Never use steel wool around the equipment! The particles cause rust and they get into places where they can cause trouble.

Power cables and wiring: Check, clean, and tighten the radio "A" ground. This connection can corrode due to



electrolysis, even though several feet from the battery. Remove the caps from any power plugs and visually inspect the connections. Clean and lubricate the plug threads. Check, clean, and lubricate plug contacts.

Upon completion of the check for the primary power supply, measure the voltage drop at the radio unit. It should not exceed .5 volt. A drop of .7 volt or more should be corrected.

Cables: Check and repair, or replace, as necessary. Check for frayed or broken insulation and loose, broken, dirty, or corroded connections. Remove all plug caps and visually check all wires and connections. Clean and lubricate the plug threads. Clean and lubricate the contacts. Check the antenna leads for shorts, opens, intermittents. If in a mobile installation, be sure the cable isn't mashed where it goes under a seat or through a bulkhead. Clean the insulator. Check the antenna mount for mechanical security. Finally, check the antenna itself.

The radio unit: Begin with the power supply. Check visually for broken, burned, or otherwise defective parts. Clean as required. Check the vibrator against a known good one by substitution. Remove the end bells from the dynamotor and check the condition of the connections, brushes, and commutators. Clean, repair, adjust, or replace as required. Check the voltages against those specified by the manufacturer. Check, clean, repair, and adjust all relays.

Next, the receiver: Check visually for any defective parts, loose or broken connections. Clean thoroughly. Move the tubes up and down in the sockets to clean the contacts. Be sure each tube is firmly seated in its proper socket. Check the discriminator for zero on the proper transmitter. Check the sensitivity; and if it is below standard make the necessary adjustments or repairs. Check the audio for both quality and quantity. Check voltages against the manufacturer's standards. If you make repairs or replace tubes, be sure to check the alignment and bring the receiver up to the proper sensitivity.

The transmitter: Check visually for defective parts and connections. Clean thoroughly. Check the voltages. Check the relays. Clean, adjust, repair wherever necessary. Check the frequency and the deviation. Adjust the frequency to exactly plus or minus zero kilocycles—not just to within tolerances. Check the quality of the modulation. Check the r.f. power.

Accessories: Be sure to check in the same manner as any other equipment. In a mobile installation, there are control heads, loudspeakers, microphones, etc. In a base station, there might be one or more remote-control units, microphones, speakers, and handsets.

Before finishing with the transmitters and receivers, make doubly sure that they are properly netted. In a two-way system, the transmitters and the receivers must all be on the same

frequency. This does not mean just within FCC tolerances. Adjust all receivers and all transmitters to be on the *same* frequency as well as within correct frequency limits.

After you have finished with a unit, give it an air check. If it is a base station, contact enough vehicles so that you are positive the station is functioning normally. If it is a mobile unit, contact the base station and/or other vehicles. Be sure, after re-installing a unit in a vehicle, that you retune the unit to the vehicle's antenna. The antenna on the vehicle might not happen to match your shop dummy closely enough.

Be thorough in your checking. Remember that it is to *your* advantage to keep the equipment operating with as little service as possible. Don't skip over something just because it is apparently operating normally. The principal aim is to keep the equipment operating. The more thorough you are with these checks the fewer unexpected breakdowns you will have.

Learn to use your senses in your maintenance. After you become acquainted with a unit, you will be able to detect much regarding its condition just by listening to it. A burned component will reveal itself to your nose, and your eyes will spot broken parts, wires, and connections, many times before you can trace them down with a meter. Your sense of touch warns you of overheated parts before they become dangerously hot. Learn to use your senses unconsciously—be constantly alert to catch a fault before it causes trouble.

These checks won't do much good unless you maintain proper and adequate records. If you haven't already done so, set up a record system. The FCC requires certain minimum records, but yours should go far beyond the FCC requirements. Your records should reflect the actual condition of the equipment at all times, the frequency of routine checks, the frequency of unexpected "outages," and the maintenance cost to you in salaries and parts.

Whenever you take the contract to service an established system, give the entire system a proper routine check *before* you accept it for contract service. During the course of this check, bring all of the equipment up to the standard of the manufacturer. This is only reasonable and will protect you against extensive repairs on a maintenance-contract basis. A properly installed and maintained system should operate at least three months between routine checks.

Proper maintenance cannot be performed without proper test equipment. Every idea expressed here applies equally to the maintenance of your test equipment. Keep meters calibrated so that they mean what they say. Keep your jigs and test cables in good repair. Keep your shop power supply in good condition—batteries fully charged, chargers operating normally. Good maintenance can only be



A "must" for two-way service is a monitor like the Motorola unit shown in use here. It measures modulation deviation and r.f. carrier-frequency departure directly in kilocycles.

performed by a good technician using good equipment in good condition.

This type of service is called "preventive maintenance." It is designed to prevent the need for troubleshooting that results when equipment breaks down unexpectedly. Properly organized and conducted, preventive maintenance will disclose faults before they become serious, thus giving you the opportunity to avoid many subsequent, substantial repairs.

This approach has three distinct advantages: 1. It reduces the number of breakdowns and increases the efficiency of the system, thus creating customer good will. 2. It permits the service outfit to *schedule* the work rather than to wait for a customer to call with trouble. 3. It permits the service organization to handle more work without additional salary and equipment costs.

-50-

This typical upright, high-gain, low-band antenna, rising above the TV antennas, identifies the fixed station.

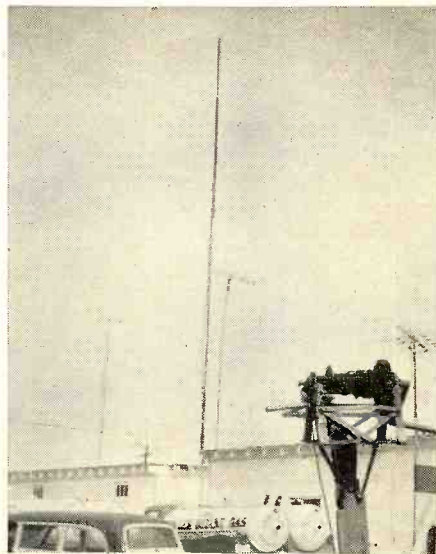



# Electrostatic Loudspeakers

## Questions and Answers

By WARREN PHILBROOK

*Just what is the story on the use of electrostatic speakers for hi-fi systems?*

ELECTROSTATIC speakers is a subject about which there has been considerable controversy, especially at "the engineering level." The controversial atmosphere has been largely promoted by the fact that each engineer contributing to it works for a company which either does or does not make an electrostatic loudspeaker. This fact follows a natural human tendency which may affect the conclusion the engineer is likely to draw. But the net result to the laymen is that he finds himself confused about the whole issue. One writer convinces him an electrostatic loudspeaker is a complete waste of money and another convinces him he doesn't have a hi-fi system without one. Which is he to believe?

The truth must be somewhere between these extremes. So we will try to assess the merits of this kind of speaker by answering some of the pertinent questions that crop up from time to time, starting with the most obvious.

**Question 1.** *What will an electrostatic tweeter add to the reproduction of my hi-fi system?*

The simplest answer to this question, assuming that the electrostatic tweeter behaves as perfectly as one can behave, is that it will reproduce the range from well below 5000 to 20,000 cycles with very good uniformity. But to the layman, this statement sometimes gives the impression that the electrostatic tweeter is handling three-quarters of the frequency range, because 5000 to 20,000 cycles is numerically three-quarters of the range from zero to 20,000 cycles. This impression arises from lack of familiarity with what physicists call "Fechner's Law."

This can be explained quite simply by pointing out that the musical spectrum from 20 to 20,000 cycles consists of

about 10 octaves. Each octave is a musical interval that sounds like the same change in pitch to the ear and represents a change in frequency of two to one. Multiplying 20 cycles by 2 gives 40 cycles. Multiplying a second time gives 80 cycles, a third time 160 cycles, and so on. The tenth time brings us up to a little over 20,000 cycles. Each one of these steps represents the same "amount" of frequency range as far as the ear is concerned.

Although frequencies as low as 20 cycles are audible, frequencies needed in musical (or other) program material seldom fall below about 40 or 50 cycles. There may be harmonics of some of the high pitched instruments (up to 20,000 cycles) that are audible but there is only a very small amount of sound energy in this top octave.

Equipment that gives uniform response from 40 to 10,000 cycles does not sound appreciably inferior to one that gives uniform response from 20 cycles to 20,000 cycles. This represents knocking off one octave from each end, leaving a range of 8 octaves instead of the original 10. If we take the 10-octave figure, then the electrostatic tweeter will handle the top 2 octaves or  $\frac{1}{5}$ th of the audible range. If we take the 8-octave figure, the electrostatic tweeter handles the top octave, or only  $\frac{1}{8}$ th of the most useful range. This gives a better assessment of how much the electrostatic tweeter will add to the over-all sound picture.

Although the electrostatic tweeter only adds the last one, or at most two, octaves, this band is important to a sense of realism or presence. But there is a danger of trying to assess it by comparative listening. You expect to hear something too "tangible." This last octave or so really adds "definition" to the picture, rather than giving

Typical high-quality electrostatics. Pickering unit is at left; JansZen at right. Such units should be considered more than simply tweeters as they operate well down into midrange.

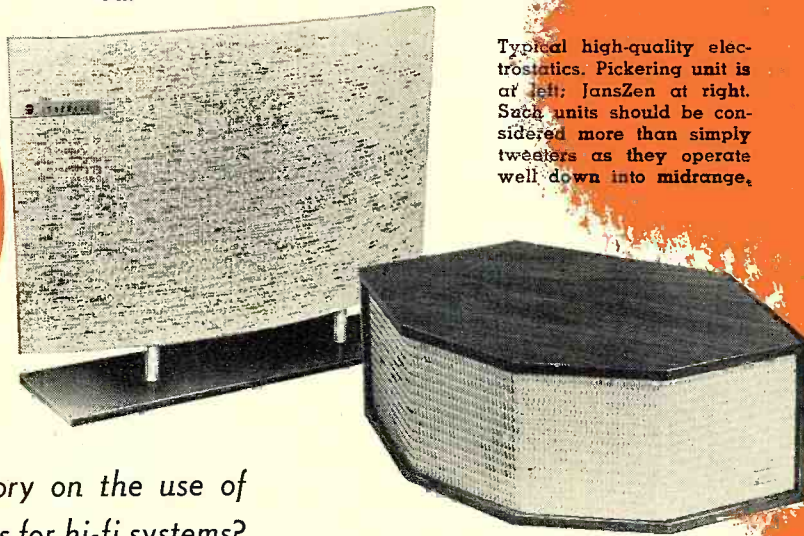

it any additional "color" or "scenery." So don't listen with the object of hearing something you didn't hear before. It will not make audible any additional instruments that were not audible before. Listen rather for the clarity or sharpness of the things you already could hear.

Some demonstrations of tweeters have deliberately accentuated these very high frequencies, which very often contain almost as much noise hiss as program components and thus many listeners have (not without justification) gotten the impression that the only thing the tweeter adds is "a bit more noise." This effect is particularly noticeable if the tweeter has coloration, that is, if it emphasizes certain frequencies in this additional frequency band more than others. This is one of the advantages of electrostatic tweeters, in comparison with some other types: that normally, they give a smoother frequency response over the range.

The other particular thing to look for in the performance of a tweeter is the way it distributes the frequencies within its range. It should not be highly directional, nor, on the other hand should it be extremely non-directional. Neither gives a good representation of the original sound pattern. The high-frequency radiator or tweeter should radiate these frequencies in a manner similar to those immediately below the same range, so one does not get the impression of the frequencies above 5000 cycles being squirted, or widely dispersed, in a manner quite different from the frequencies lower down.

This is important because the prop-



erties of these high frequencies is to add definition to the lower frequencies. If they become separated due to a different directional distribution, this objective is often lost.

**Question 2.** *How does the electrostatic tweeter compare with other types?*

There are three basic types of tweeter one can consider here. The electrostatic, the direct cone radiator, and the compression driver. These are shown in Figs. 1, 2, and 3. There are two bases for comparison: (1) the smoothness of frequency response; and (2) the directional pattern of the radiation.

A well-designed electrostatic tweeter has a smooth frequency response, because it avoids the problem encountered by each of the other units. The whole of the diaphragm is driven by the electric driving force and most of its surface area also radiates sound.

Sometimes the diaphragm is curved into a cylindrical shape and sometimes it is only slightly curved, almost flat. This will alter the radiation pattern considerably. The cylindrical or half cylindrical shape gives a wide-angle distribution, almost uniformly. The shape coming nearer to flat tends to beam the sound in a comparatively narrow angle. Somewhere between these two extremes is probably ideal for giving the best frequency distribution to match the rest of the system.

The direct radiator is really a miniature cone-type loudspeaker and this type may suffer from non-uniformity of frequency response, because the diaphragm inevitably "breaks up" at the high frequencies so one part is traveling forward while another part is traveling backwards. This not only may cause a non-uniformity in the frequency response, but also a non-uniformity in its directional characteristics. As a result this type of tweeter produces a radiation of the extreme high frequencies that may be unlike the distribution produced by most kinds of musical instruments.

The compression driver, on the other hand, has a much different type of distribution. Its horn loading of the diaphragm produces a good uniform response, comparable to that of the electrostatic. The different types of horn available will produce different radiation patterns similar to the effect of different shapings in the electrostatic diaphragm. So the choice seems to rest (from this standpoint) between the electrostatic and the compression driver types.

**Question 3.** *Announcements have been made about electrostatic loudspeakers with a wider range than just tweeters. What are the prospects for wide-range electrostatic loudspeakers?*

The basic problem here is quite an old one. The electric driving principle involves electric forces between the "plates." These forces are very small and quite insufficient to produce an acoustic drive unless the plates are placed very close together, but a very

close spacing limits the possible travel of the diaphragm. The third factor in this department is the workable high-voltage polarization that can be used before ionization of the air takes place.

The combination of these design factors means that a certain air movement requires a definite area of diaphragm, much bigger than with the cone-type loudspeaker. It seems that, with the best design, the dimensions of the loudspeaker both ways (height and width) must be a little larger, at least, than the lowest wavelength to be radiated. So a loudspeaker to radiate down to 1000 cycles would need to be more than 1 foot wide and high. Going down to 500 cycles would need a loudspeaker with a dimension of considerably more than 2 feet in each direction, and so on.

These loudspeakers have been constructed and are appearing on the market, and they give an extremely uniform frequency response over the range they cover. Their directional characteristic is a subject of some controversy, however, because they do tend to radiate a wave that follows the shape of the diaphragm, whatever that may be, usually a slight curvature from flat. This, again, is less like the wave radiation from any true musical source. The question really reduces to which is the more important, the uniform frequency response or a certain kind of distribution of the sound energy.

Another thing to listen for in some electrostatic loudspeakers is something that does not show up too well on the frequency response. This is a certain coloration of the program due to a metal diaphragm being used. All vibrating metal parts *tend* to have a quality of their own, almost like a resonance. It is not a true resonance, because it is not concentrated on any one frequency. But it does produce a kind of coloration to the presentation, that can be quite noticeable, as compared with the softer or more viscous materials like impregnated paper and certain classes of plastic, that are used as diaphragms for the cone loudspeakers.

The effects of these differences can only really be assessed by listening for individual choice.

**Question 4.** *A lot has been said about distortion in electrostatic speakers. Do they distort more than other types, and if so, is it possible for this distortion to be minimized?*

The reason for distortion in an electrostatic loudspeaker is illustrated in Fig. 4. The force of attraction between

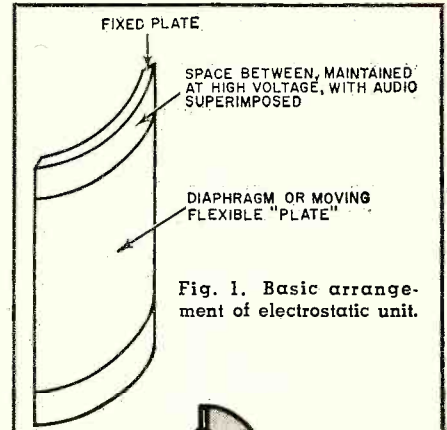

Fig. 1. Basic arrangement of electrostatic unit.

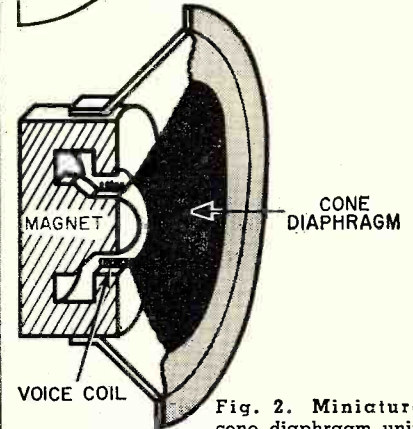

Fig. 2. Miniature cone diaphragm unit.

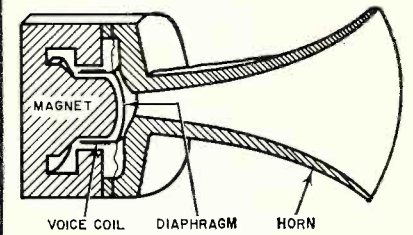
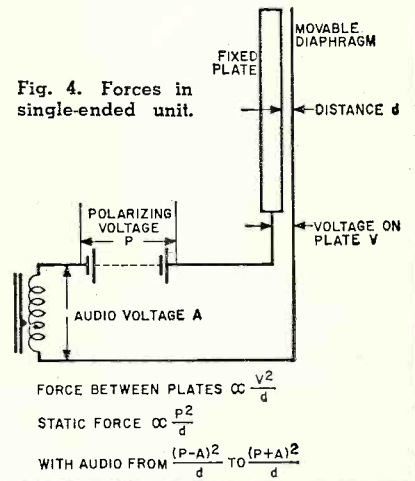
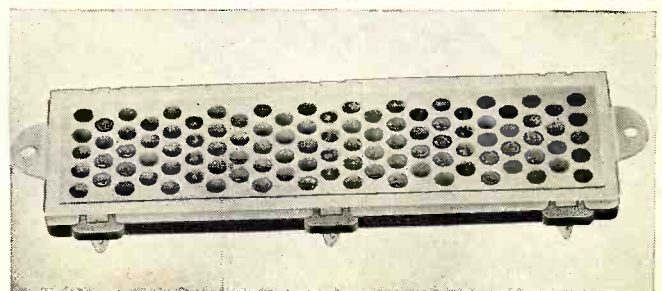

Fig. 3. Compression driver tweeter.



The Isophon electrostatic tweeter is both small and inexpensive.





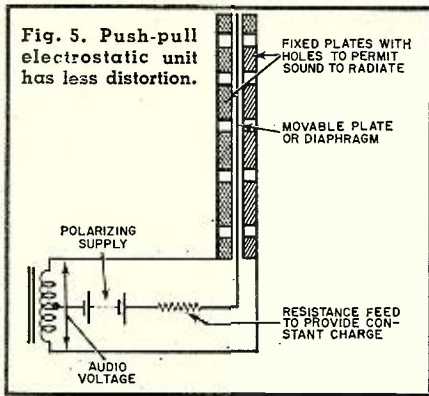

plates of an electrostatic loudspeaker is proportional to the square of the instantaneous voltage and inversely proportional to the spacing between them. By using a high polarizing voltage between plates, the *change* in voltage is kept relatively small and this will minimize the inherent distortion in the driving force *provided the diaphragm does not move*.

Suppose the peak audio voltage is 10% of the polarizing voltage. This means the force between plates will go up to 1.21 times the static force, and down to .81. So there is a peak fluctuation of 20% of the static force, with a harmonic component of 1% peak-to-peak. (Fig. 6.) This represents 2½% harmonic distortion. But notice the words in italics at the end of the last paragraph. We assumed the diaphragm does not move.

When the higher voltage is applied, the diaphragm moves closer to the fixed plate and so the driving force is increased even more. When the audio voltage reduces the static voltage momentarily, the plate moves farther away and so the driving force is reduced even more. So the practical distortion component will be even more than the theoretical, based on the assumption the diaphragm does not move.

The first step to overcome this consists of putting the diaphragm between *two* fixed plates and allowing the sound to radiate through holes in the fixed plates, as shown in Fig. 5. In this case the total driving force, due to the change in potential between the moving plate and *both* fixed plates, will be the same in both directions. This produces a great improvement towards linearity or freedom from distortion. Speakers of this type give extremely low distortion but, for

wide-range construction, will still produce some. This is because the diaphragm has to move. Consequently the plate to which the diaphragm happens to be nearest, at an instant, will momentarily exert more than its share of driving force.

What distortion this method leaves will be of a higher frequency, or harmonic order, than with the single-ended arrangement, because it is symmetrical. (Fig. 7.) This distortion is overcome by using a *constant charge* system. The diaphragm is maintained, not at constant potential, but at constant charge, relative to the other two plates. This neutralizes the distortion by changing the momentary voltage differences, to exactly offset the change in spacing as the diaphragm moves. The result is a driving force exactly proportional to the *applied terminal voltage* at all times, and not to the voltage *differences* occurring between the individual plates. The constant charge is maintained by feeding the voltage to the center plate or diaphragm through a resistance, sufficiently high so that the charge will not have time to change during the audio fluctuation. (Fig. 5.)

The exact importance of the distortion discussed is somewhat affected by the frequency range handled by the unit. In the case of tweeters, which handle only from 5000 cycles up, the distortion from a single-ended type will be second harmonic, so the principal distortion from frequencies between 5000 and 10,000 cycles will be between 10,000 and 20,000 cycles. As these components are usually radiated at quite small magnitude, anyway, their distortion is often quite inaudible. Certainly distortion to frequencies between 10,000 and 20,000 cycles will *never* be audible. So, in practice, it would require a very good pair of ears to tell the difference between a single-ended tweeter and a push-pull one, for the range only from 5000 cycles up.

**Question 5.** *How about matching an electrostatic speaker to an amplifier. Do we need a special crossover, or how do we manage this?*

The basic impedance of an electrostatic loudspeaker is produced by a capacitance, not a resistance. A capacitance has the property that its reactance or impedance is inversely proportional to frequency. It may

have a reactance of 20,000 ohms at 5000 cycles, 10,000 ohms at 10,000 cycles, and 5000 ohms at 20,000 cycles.

If the diaphragm were perfectly free to move at all frequencies following exactly the electric force applied to it, a constant voltage applied to the terminals of the loudspeaker would produce a constant magnitude of movement at all frequencies. In terms of audio pressure or velocity, this would be a rising characteristic of 6 db per octave. However, the diaphragm does not have time for its movement to follow fully the voltages applied because it is mass controlled by the weight of air it has to drive. This means the voltage exerts a force that *tends* to move the diaphragm but it never has time to reach the extreme of its possible movement. These two effects interact in much the same way they do with a cone loudspeaker, to produce an approximately flat frequency response.

Thus we need a constant voltage applied to an impedance that falls off so the current taken is proportional to frequency. Matching is usually taken care of in the matching arrangement supplied with the tweeter or the electrostatic loudspeaker. A transformer is provided to match the capacitance of the loudspeaker so it will feed in conjunction with a normal resistance-type voice coil.

This does not mean, however, that the amplifier will no longer be supplying a capacitance load. The transformer does not magically change the kind of impedance produced by the tweeter, merely its relative value, to make it like a much larger capacitance.

Because of this you should not use the same kind of crossover you would with a dynamic-type tweeter. The dynamic tweeter provides a correct termination for a convenient crossover unit while the electrostatic does not.

The electrostatic unit, however, tends to make its own crossover, because the impedance rises below the frequency we are interested in, usually 5000 cycles, so the tweeter does not accept any energy below this point. This, in conjunction with the built-in matching transformer, and the fact that the low-frequency unit has an inductive voice coil, acts almost as a natural built-in crossover. Usually the circuit supplied by the tweeter manufacturer

(Continued on page 101)

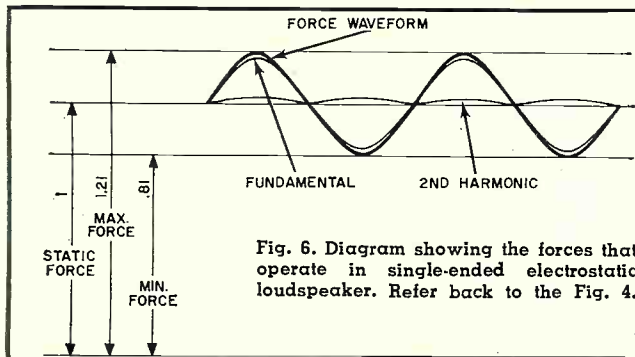
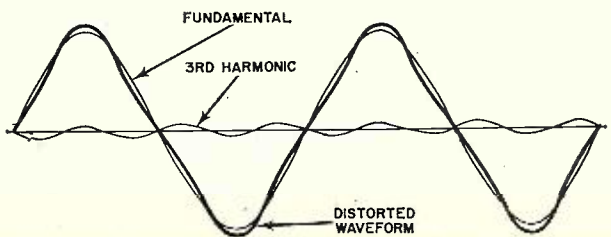
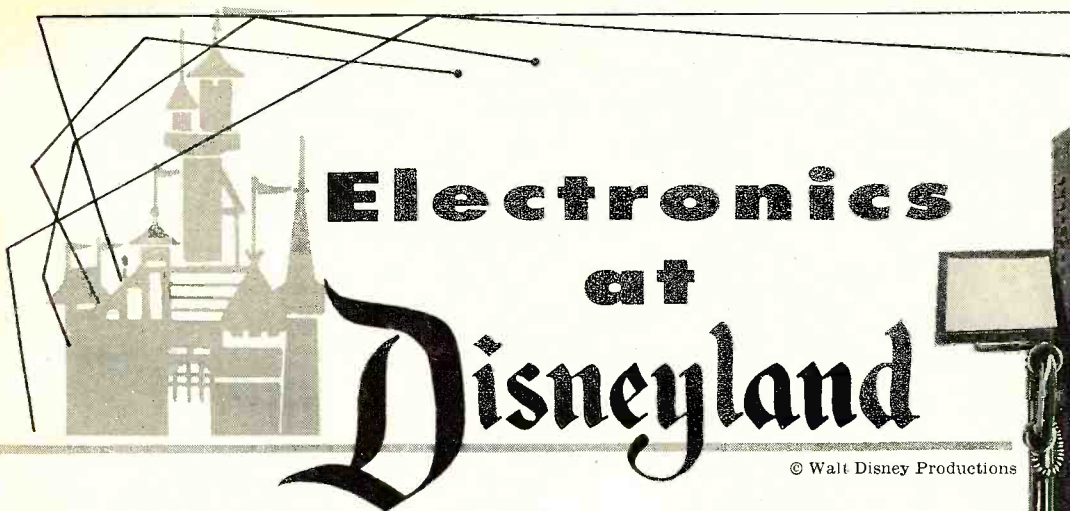

Fig. 7. Residual distortion of push-pull unit, due to the change of the speaker's capacitance with diaphragm movement.







# Electronics at Disneyland

© Walt Disney Productions

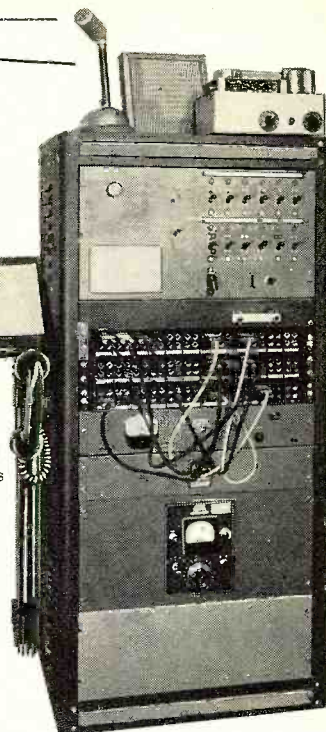

Sound maintenance men have to look after and take care of over 500 pieces of audio gear.

**M**ORE than 11 million people who have already visited Disneyland in Anaheim, California may never be aware of it, but their enjoyment is greatly enhanced by more than 500 varied pieces of tape, amplifier, microphone, speaker, and projector equipment.

Throughout the park's 60 acres, the electronics equipment is utilized for a variety of special effects and as a constant accompaniment to each individual attraction, ride, exhibit, and show—which right now totals more than 50.

Extensive use is made of tape equipment. For example, 120 MacKenzie tape repeater units are used for the various rides. These play a maximum of 5 minutes of continuous sounds, although most are set for just a few seconds of sound effects, as may be required.

Altec's 408A speaker is the most often found single equipment model in Disneyland. The park has 150 of these in use, all indoors. For outdoor speaker requirements, Disneyland has 30 Electro-Voice Model CDP 842's and 40 University 1B8's.

For its over-all music system, the park makes use of a variety of tape machines. These play four hours of continuous music, then reverse automatically for another four hours of playing time. Tapes are on 14-inch reels and play at 3¾ inches per second.

It takes the combined efforts of seven sound-maintenance men employed by the *Ralke Company*, plus a projector repairman, to keep all the electronic equipment in proper working condition.

With more than 500 individual pieces of equipment to maintain, repair, and install for the many attractions and the constant flow of new developments, they're some of the busiest sound maintenance men in the business.

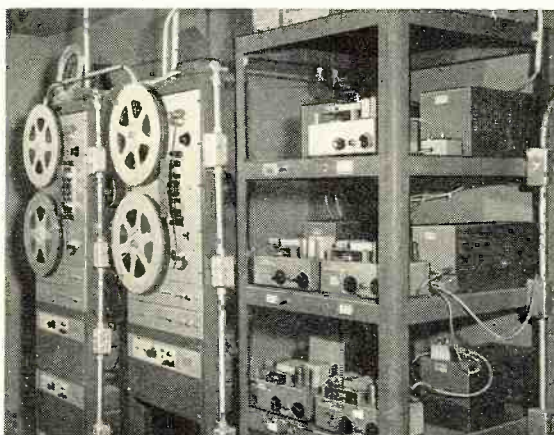

↑ Here is some of the equipment that is employed for sound effects and musical background in Fantasyland castle display.

← Disneyland "paging" system, or over-all public address equipment for reaching someone in the park. Altec equipment and specially built gear by the Ralke staff is employed.

## QUANTITY AND TYPES OF ELECTRONIC EQUIPMENT USED

120 MacKenzie repeater units (Model 101)	15 Altec microphones (Model 660B)
5 Presto tape machines (Model 17B)	35 Shure microphones (Model 777X)
5 Ampex tape machines (Model 450)	60 Turner microphones (Model 70D)
10 Stromberg-Carlson tape machines (Model AU42)	30 Electro-Voice speakers (Model CDP 842)
20 Altec p.a. amps. (Models 342 & 1520)	40 University speakers (Model 1B8)
11 Bogen 4-watt amps. (Model BT12)	150 Altec speakers (Model 408A)
10 Challenger amplifiers (Model CD12)	5 Kinebox 35 mm. 4-channel tapes
2 Stencil Hoffman 50-watt amps.	17 Eastman Kodak projectors (Model 25)
35 Altec amplifiers (Model 333)	6 Eastman Kodak "Pageant" projectors
	3 Simplex 35 mm. projectors (Model E-7)



## THIS MONTH'S COVER

**O**UR cover photo this month shows the colorful "Mark Twain" riverboat ride at Disneyland with a full band of brightly dressed musicians aboard. The barker, in foreground, as well as the three public-address speakers at the bottom of the photo are symbolic of the very widespread use of p.a. systems at the park. The barker is using a Motorola transistorized megaphone, the "Power Voice." The speakers are, from left to right, a University radial, an Electro-Voice compound diffraction projector, and a University "Cobreflex." (Photo by Peter J. Samerjan)



# I.F. Alignment?

## t's Easy!

By **BOB ELDRIDGE**

*Do you avoid alignment unless it's absolutely necessary? The job's easier than you think.*

**A**LTHOUGH i.f. alignment is very important for the correct operation of a TV set, there is a feeling of "magic" in the term in some quarters. As a result, many competent technicians have never actually carried out an alignment.

After very little practice, an alignment check can be performed quite rapidly and easily. If no adjustment is necessary, the whole process of setting up and examining the waveform can be accomplished in ten or fifteen minutes.

Apart from the obvious reason for alignment—obtaining the best possible picture—there are many troubles which can be readily pinpointed by a sweep check. Inadequate gain (which stage is it?), i.f. regeneration (at which point in the strip?), grain in the picture: these are some of the faults which can be tackled conveniently by this method.

Most manufacturers' instructions for alignment specify the use of a v.t.v.m. for peak indication. Apart from the waste of time in changing over from the v.t.v.m. to the scope for viewing the waveform, there is a great disadvantage in using the meter. It can show that the stage is peaking on the desired frequency, but it does not indicate *whether the peak amplitude is as high as it should be*. Thus it is possible to go through the entire alignment procedure only to find, when the curve is viewed on the scope, that the response is totally wrong due to some defect in a stage that can nevertheless be peaked to frequency.

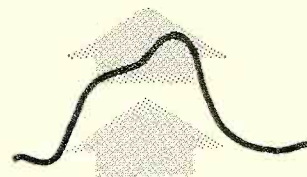
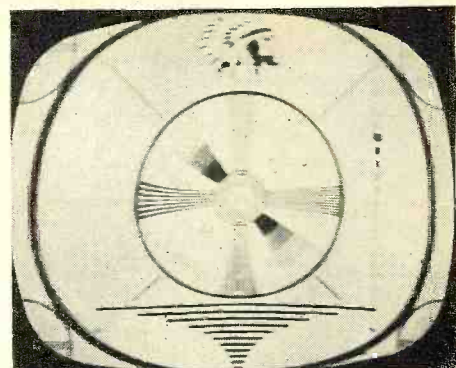
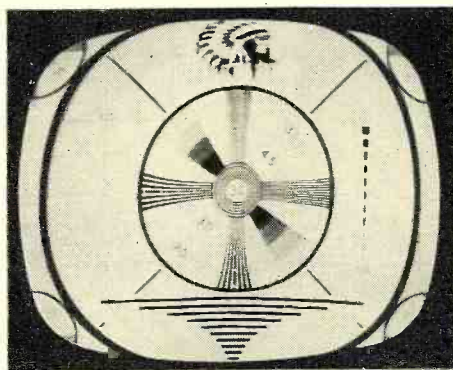

Reproduction obtained on the same receiver, before and after alignment. Set owners recognize the difference.

Why not use the oscilloscope as your voltmeter and, at the same time, keep your eye on the waveform being produced by your efforts? If a mis-adjusted trap is seen to be distorting the response, it can be moved out of the way before you go on to the next scheduled adjustment. If the gain is low or unobtainable at one point, the alignment can be suspended and attention concentrated on the stage in question. By comparing the height and width of the waveform before and after adjustment, you can obtain a definite idea of what the alignment has accomplished.

Fig. 1 shows a typical i.f. response curve. Translated into words, what does this curve tell us? Just that the response of the i.f. strip produces the following voltages across the video detector load resistor: at 21.6 mc., .2 volt; 23.1 mc., 1.8 volts; 23.5 mc., 3 volts; 25.4 mc., 3.1 volts; 26.1 mc., 1.5 volts; and 27.6 mc., .1 volt.

If we wish to identify a point on this curve corresponding to a particular frequency, say 23.1 mc., we must superimpose a "pip" from our marker generator, as shown in Fig. 2A.

If now, using the scope horizontal centering control, we shift the pattern across the screen until the "pip" is resting on the heavy center line of the transparent scope-screen overlay, as shown in Fig. 2B, we can turn down the marker-generator output until the "pip" disappears (or until it ceases to disturb the waveform) and regard the center line as representing 23.1 mc.

We can now adjust the 23.1 mc. coil or transformer. Then, when the curve is adjusted to cross the center line at the highest point vertically, we know we have peaked the coil on 23.1 mc.

By successively tuning the marker generator to each frequency recommended in the service manual, centering the "pip" on the scope, and adjusting for highest crossover point in each case, we are using the scope as a voltmeter on selected frequencies, with the advantage that we can now view the alignment continuously as we go along. After a little practice, it is easy to use the nearest vertical grid line for reference, instead of moving across to the center each time.

### Trap Alignment

Alignment of traps is most easily accomplished with an audio-modulated marker. When the marker frequency is inserted, the audio will appear on the base line, as illustrated in Fig. 3. It will usually be necessary to increase the gain on the scope in order to reveal the marker modulation. The trap is then adjusted for minimum amplitude of the audio. It is much easier to see the dip in modulation amplitude than it is to judge the small difference in response at the trap frequency.

### Auxiliary Equipment

It is most important that the correct bias voltage be applied to the i.f. a.g.c. line during alignment. If no information is available for the set on the bench, it is usually safe to use about -3 volts.

The simplest form of bias box is shown in Fig. 4. Other boxes can be readily devised if you object to the use of batteries. If a high-resistance pot is used (to reduce battery drain if the switch is accidentally left on), it



is important that you check the bias voltage when connected to the set. This habit is useful for two reasons: it keeps a check on the condition of the battery and it prevents a comparatively low bias-line-to-ground resistance from upsetting the calibration of the bias box by shunting across the top arm of the potential divider. (It also warns on occasion: "You have connected the box backwards!")

### Signal Insertion

The best and safest way to feed the sweep signal to the i.f. strip is with a dummy oscillator-mixer tube. The mixer section must be working normally, but the oscillator section should be disabled by clipping off the grid pin. If the oscillator is working, it will often produce many confusing false markers and a different response curve can be produced on each separate channel.

Make connection from the mixer tube shield, either lifted from ground or split, to the coax cable from the sweep and marker generator, as shown in Fig. 5. The cable should be correctly terminated with its characteristic impedance to avoid standing waves.

It is easier to locate the marker exactly on the slopes of the curve when it is thin. The thickness of the marker can be controlled by a capacitor connected across the scope vertical-input terminals. The value should be chosen experimentally and, once established, is good for all alignments. The larger the capacitor, the thinner will be the marker, due to a reduction in high-frequency response at the scope input. Fig. 6 shows how the marker appears, with and without shunting capacity.

The scope input should be through a resistive probe or a direct probe with a resistor of 10,000 ohms or so in series with the tip.

Don't neglect good grounding straps. A good r.f. ground connection is essential between the test equipment and the chassis of the TV set. The outer braid from coaxial cable, stripped off and flattened, makes excellent, flexible grounding wire. If, when a hand is placed on the chassis, the response curve changes, add more grounding wires until the chassis is quite cold to r.f. It doesn't help at all if you can "align" the set by waving your hands in the air around it!

Use plenty of gain on the scope but not too much input from the sweep generator. In general, the peak-to-peak waveform on the scope should not be higher than about 5 volts. Too much input from the generator can produce a beautiful flat-topped curve due to saturation of the i.f. tubes, but there is no knowing what the response is really like under proper signal conditions.

If you like to use a straight base-reference line for the response curve, use the blanking control, but always switch it off again when the job is completed. When setting up the scope, first adjust the phasing control to superimpose the trace and retrace pat-

terns and then switch on the blanking control to blank out one of them. If the blanking control is already on and the phasing control improperly adjusted, the most weird and puzzling patterns can be produced. If you find it necessary to tune the sweep generator to an unusually high or low center frequency in order to center the pattern on the scope, always check the phasing control to see if it has been accidentally misadjusted. If you make a habit of switching off the blanking control when finished with the scope, two separate patterns will show on the screen the next time you use the scope should the phasing control have been moved.

### Custom Alignment

If a very "fussy" alignment has to be made, it may be useful to modify the bias according to the conditions under which the set is to be used. For example, for fringe reception only, the alignment could be done with about -1 volt bias or, for reception of strong signals only, it could be set at -4 volts. In each case, the intention is to make the response correct at the bias voltage which the a.g.c. of the receiver will produce in operation.

The actual shape of the curve can also be modified to fit abnormal conditions. For use in a fringe area, the bandwidth could be reduced to 2.5 mc. or so, which will make a little more amplitude available to increase receiver sensitivity. For a set operating exclusively on a very strong signal, some gain can be sacrificed in favor of

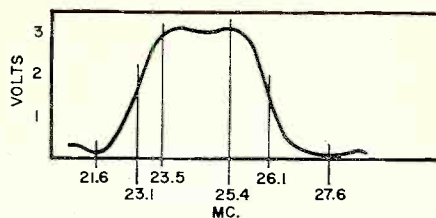

Fig. 1. Typical i.f. alignment curve.

an increase in bandwidth, making possible a more detailed picture.

Sound traps can be used for "custom" purposes or extra ones can be added. For example, if there is no adjacent-channel sound problem in your area, but some interference shows on channel 5 from communication services in the 4-mc. band between channels 4 and 5, you can adjust the adjacent-channel trap to suppress the other interference.

Occasionally, in an extremely strong signal area, it may be found that sound bars and/or grain appears in the picture due to insufficient attenuation of the sound carrier in the i.f. strip. There is a simple method of re-adjusting the sound trap which will often do the trick without resorting to modification of the set wiring. Fig. 7A shows an i.f. transformer and its associated sound trap. The tuned trap is toward the top of the illustration. Leads for the primary and secondary of the transformer are shown at the bottom. The broken lines show the usual positions of the slugs when the assembly is properly tuned. Coupling

(Continued on page 111)

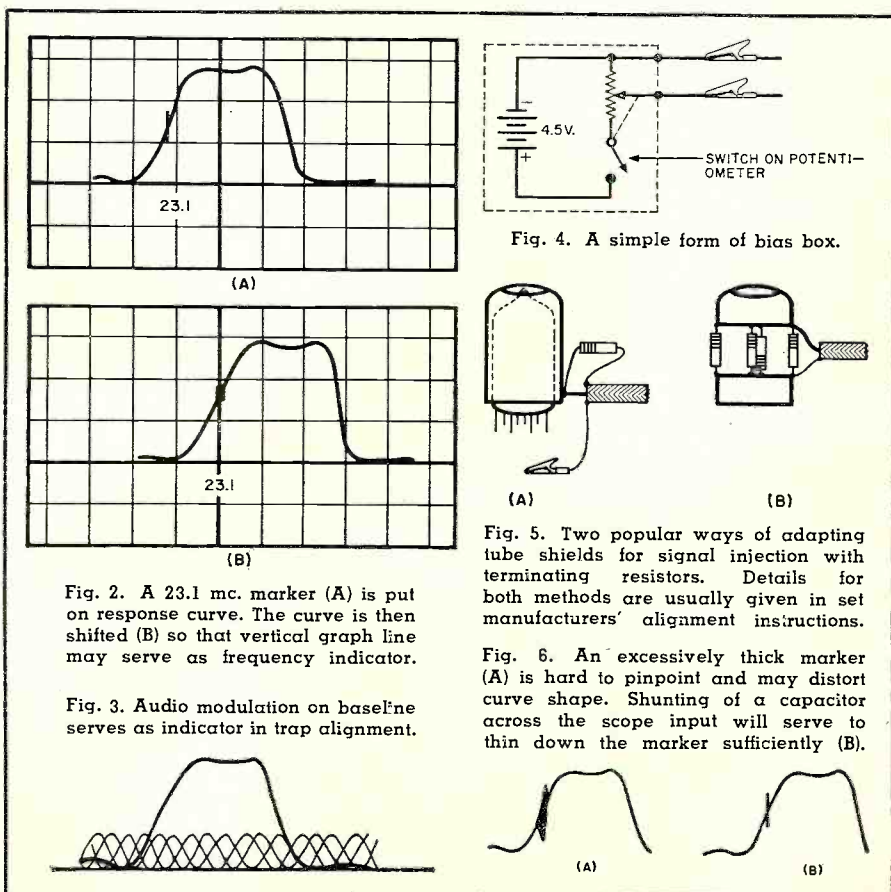

Fig. 2. A 23.1 mc. marker (A) is put on response curve. The curve is then shifted (B) so that vertical graph line may serve as frequency indicator.

Fig. 3. Audio modulation on base line serves as indicator in trap alignment.

Fig. 4. A simple form of bias box.

Fig. 5. Two popular ways of adapting tube shields for signal injection with terminating resistors. Details for both methods are usually given in set manufacturers' alignment instructions.

Fig. 6. An excessively thick marker (A) is hard to pinpoint and may distort curve shape. Shunting of a capacitor across the scope input will serve to thin down the marker sufficiently (B).



# EXTEND

## Your Signal Generator's Range

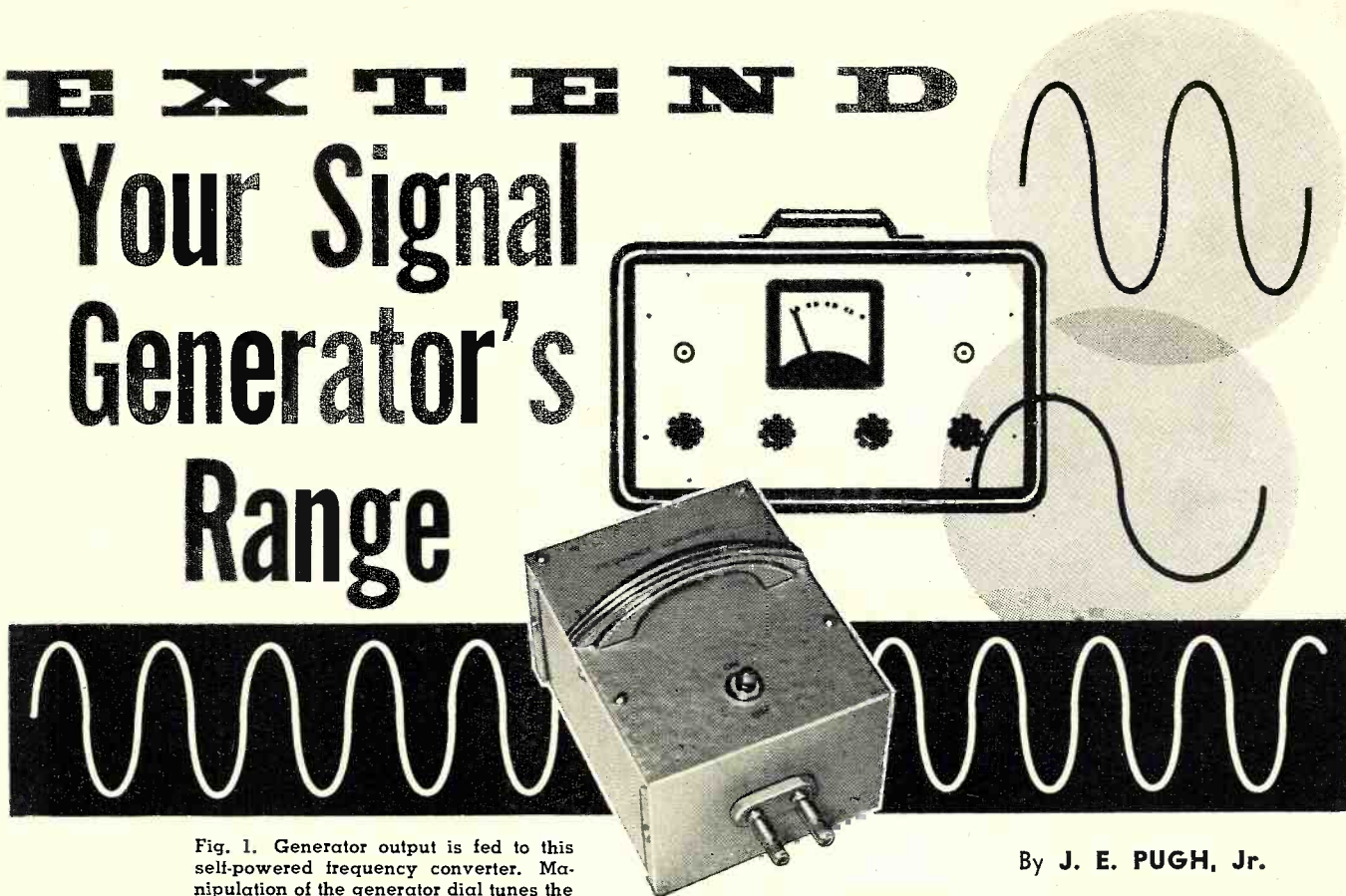

Fig. 1. Generator output is fed to this self-powered frequency converter. Manipulation of the generator dial tunes the adapter's output over the added range.

By J. E. PUGH, Jr.

*Use this compact, transistorized accessory to get another band out of an existing signal generator.*

THERE ARE few signal generators whose usefulness would not be considerably increased if their frequency ranges could be extended. This could even be said of new ones, not to mention nearly obsolete service generators, nearly useless surplus generators, or any generator having a range close to the desired one. For example, the accessory unit to be described made it possible for a *Measurements* Model 80 signal generator, with a normal range of 2 to 400 megacycles, to be used down to a few cycles. Simple modifications make it possible to add new ranges to most other generators at a very low cost.

Best of all, if an independently powered accessory unit of compact size can be made up to provide the desired extension in range, the original instrument can be used separately over its own range when desired. An addition of this kind is readily realized with a couple of commonly available transistors.

A block diagram for the range extender is shown in Fig. 2. The heterodyne principle is used for obtaining the new range of frequencies by mixing the output of the signal generator ( $F_1$ ) and the fixed-frequency ( $F_0$ ) oscillator of the extender in a balanced modulator circuit. This mixing action produces two new frequencies—the

sum of the generator and oscillator frequencies ( $F_1 + F_0$ ) and the difference of these two frequencies ( $F_1 - F_0$ ). Either of these frequencies can now be used depending on whether the new range is to be above or below the present range of the signal generator.

The modulator (Fig. 3) is a balanced type to aid in the elimination of the carrier frequency from the output. Either the signal generator frequency or the local oscillator frequency can be suppressed here, depending on the needs of each particular case. However, in most cases the local oscillator signal will be of greater amplitude and therefore the one requiring the most suppression.

The output from the modulator is now put through a filter to further reduce the local oscillator component, the signal generator component, the unused sideband, and all other modulation products and harmonics so as to leave only the one desired frequency.

The signal from the filter is applied to an amplifier to bring it up to the desired output level. This amplifier can use frequency compensation to maintain a constant output over the new range, if desired. If simplicity is the keynote, the amplifier can be left uncompensated. If a low output impedance is required, a grounded-collector amplifier can be the final stage.

The first thing to be considered is what new range of frequencies is desired and whether this new range will be below or above the present range. The next step is to select a frequency for the crystal oscillator near the end of, but within, the present generator scale that is also adjacent to the new range—but not *too* close to it. If it is too close, there will be some attenuation of the new range when the frequency of the crystal oscillator is filtered out.

In addition, the new oscillator frequency should be at some convenient point on the dial of the old generator for ease in determining the new frequency. For example, the lowest range on the generator used covers from 2 to 5 megacycles and the crystal oscillator frequency is 3 mc. This means that zero frequency, obtained with the accessory, will occur when the old generator is set to 3 mc. Any frequency in the new range will be obtained simply by subtracting 3 mc. from the generator dial reading. With the new range having a maximum frequency of 2 mc. (obtained at 5 mc. on the generator scale), the crystal oscillator frequency of 3 mc. will be sufficiently above the upper end of this new range for effective filtering without effect on desired frequencies. Also, since this section of the old generator range used to obtain the new range will be above 3 mc. it, too, will be removed by the filters.

The modulator is a simple balanced type using four crystal diodes. This



configuration does a very good job of suppressing the local oscillator component so as to make the filtering of the remainder of this component fairly easy. The output from the signal generator does appear across the modulator load resistor ( $R_1$ ), but is of such low level here that it is easily suppressed.

This type of modulator is a fairly efficient generator of harmonics but they, too, are of a low level and easily filtered. The crystal diodes can be almost any general-purpose type but the *Sylvania* 1N35 is particularly well suited for this use. Each 1N35 consists of a pair of matched 1N34 diodes mounted in a convenient holder. Since they are matched, the modulator balance is good. As a result, the local oscillator signal is well suppressed. For best results  $CR_1$  and  $CR_2$  should be one matched pair and  $CR_3$  and  $CR_4$  should be the second matched pair.

If the new range is to be below the present generator range, a low-pass filter will be used so as to attenuate all modulation components except  $F_1 - F_0$ . Attenuated are all harmonics, the fixed frequency oscillator output, and the signal generator output.

If the new range is to be above the present range of the generator, a bandpass filter will be needed to eliminate the unused modulation components. In this case, the  $F_1 + F_0$  component will be used and the  $F_1 - F_0$  component will be suppressed. The lower attenuation band of the bandpass filter will attenuate the fixed frequency oscillator output, the signal generator output, and the  $F_1 - F_0$  component will be suppressed.

When extending the generator range on the high-frequency end, it will sometimes happen that the generator and local oscillator harmonics will fall within the passband of the filter. In this case, the local oscillator harmonics can be reduced satisfactorily by inserting a tuned filter (resonant at  $F_0$ ) between the oscillator and modulator. The generator harmonics can be attenuated by inserting a simple low-pass filter between the generator and the modulator.

Component values are not given for the filter because, in most cases, they will vary from instrument to instrument. However, standard filter design equations can be found in many electronic handbooks and textbooks. For example Terman's "Radio Engineers' Handbook" covers all types very thoroughly. The filter can be a very simple one using only a single prototype  $T$  section, or it can use terminating  $M$ -derived half- $T$  sections with one intermediate prototype section and one intermediate  $M$ -derived section for optimum results.

With a 2N247 used as  $V_2$ , the filter can be designed for a 1000-ohm terminating impedance. If an  $M$ -derived filter is used, the  $M$  factor should be .6 for the end sections if the cut-off frequency does not need to be close to

the frequency of very high attenuation. Where intermediate  $M$ -derived sections are used, they will generally be satisfactory with an  $M$  of .3 to .4. The frequency of very high attenuation ( $F_\infty$ ) should occur at the same frequency as that of the local oscillator for maximum attenuation of this signal. Then the cut-off frequency will be determined by the value of  $M$  that is used.

For example, with the local oscillator operating at 3 mc.,  $F_\infty$  will be 3 mc. With  $M = .6$ , the cut-off frequency will be 2.4 megacycles as determined by the equation  $F_c = F_\infty \sqrt{1 - M^2}$ . If the maximum frequency in the new range is 2 mc., it will not be noticeably attenuated by this filter. If this desired frequency needs to be closer to the local oscillator frequency, it may be necessary to raise the cut-off frequency by reducing  $M$  to prevent the desired signal from being attenuated in the filter.

(EDITOR'S NOTE: The formula noted above will apply only where a low-pass filter is needed; i.e., when the new band of frequencies is to occur below the one already available from the existing generator. Where the extension of range is to occur above the existing band, and a high-pass filter is therefore

desired, the formula for the cut-off frequency is  $F_c = F_\infty \sqrt{1 - M^2}$ .)

The next thing to be considered is the amplifier. First, the value of capacitor  $C_1$  will be determined by the new frequency range. In the example described, 10  $\mu$ f. is sufficient to prevent drooping down to approximately 75 cycles and the usable output is still obtainable down to a few cycles per second.

Resistor  $R_8$  and capacitor  $C_5$  form a compensating network to keep the output reasonably level up to 2 mc. If compensation is needed to a higher frequency, reduce the value of  $C_5$  slightly. If the required range is less, then the capacitor  $C_5$  can be made somewhat larger.

The amplifier will be satisfactory for all load impedances down to about 1000 ohms but, if a lower output impedance is required, add a grounded-collector stage after  $V_2$  using another 2N247. In such a case, it may be desirable to increase output level by adding another stage similar to  $V_2$ , located between  $V_2$  and the grounded-collector output stage.

The entire unit is built on an L-shaped chassis, as shown in Figs. 4 and 5. The crystal oscillator and modulator units are built on the hori-

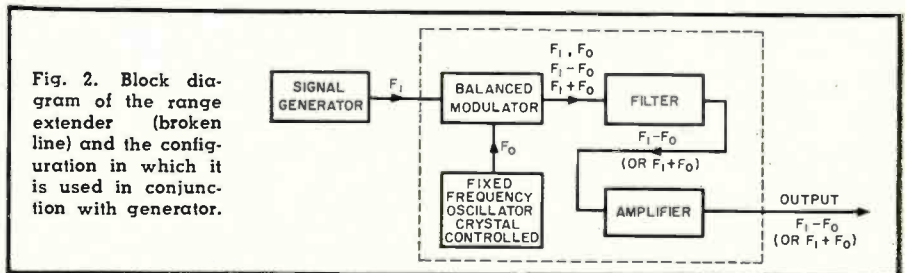
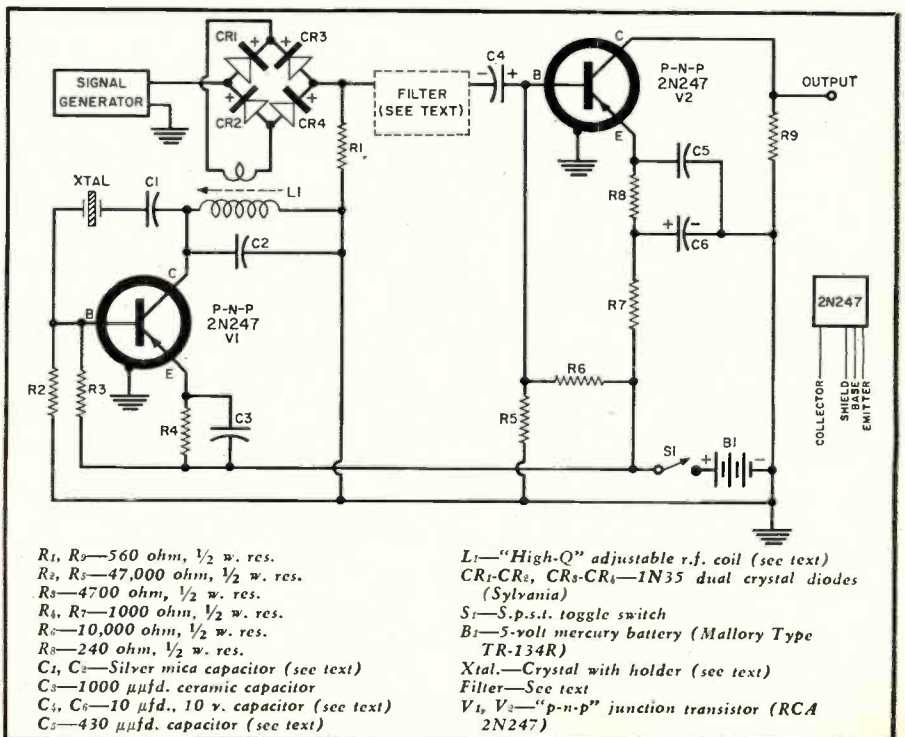

Fig. 2. Block diagram of the range extender (broken line) and the configuration in which it is used in conjunction with generator.

Fig. 3. Schematic of the extender. The new range will determine many values.



- $R_1, R_9$ —560 ohm,  $\frac{1}{2}$  w. res.
- $R_2, R_3$ —47,000 ohm,  $\frac{1}{2}$  w. res.
- $R_4, R_7$ —4700 ohm,  $\frac{1}{2}$  w. res.
- $R_5, R_6, R_7$ —1000 ohm,  $\frac{1}{2}$  w. res.
- $R_8$ —240 ohm,  $\frac{1}{2}$  w. res.
- $C_1, C_2$ —Silver mica capacitor (see text)
- $C_3$ —1000  $\mu$ f. ceramic capacitor
- $C_4, C_5, C_6$ —10  $\mu$ f., 10 v. capacitor (see text)
- $C_7$ —430  $\mu$ f. capacitor (see text)

- $L_1$ —"High-Q" adjustable r.f. coil (see text)
- $CR_1-CR_2, CR_3-CR_4$ —1N35 dual crystal diodes (*Sylvania*)
- $S_1$ —5-p.s.t. toggle switch
- $B_1$ —5-volt mercury battery (*Mallory Type TR-134R*)
- $Xtal.$ —Crystal with holder (see text)
- Filter—See text
- $V_1, V_2$ —"p-n-p" junction transistor (*RCA 2N247*)



zontal section of the chassis, and the filter and output amplifier are on the vertical section. The modulator output feeds to the filter through a small hole in the chassis directly below the filter input terminal. This layout gives good shielding and minimizes coupling of the local oscillator and signal generator signals into the output circuit.

The horizontal chassis section is  $3\frac{3}{8}$ " long and  $3\frac{3}{4}$ " wide; and the vertical section is  $2\frac{7}{16}$ " long. Metal sleeves  $\frac{7}{16}$ " long are used to mount the chassis to the top of the 3" x 4" x 5" aluminum case shown in Fig. 1.

Screw-type terminal strips are used for mounting the transistors for convenience but sockets will serve as

well. In Figs. 4 and 5, both transistors are 2N112's. These were satisfactory but it was later found that 2N247's worked better in this application. In this case, 4-screw terminal strips or 4-pin sockets will be needed instead of the 3-screw type shown.

The crystal is a low-cost *Petersen Radio* unit (Type Z-1) available for a wide range of frequencies. The exact frequency will be determined as already described.

The battery is a 5-volt mercury type for constant local oscillator output. A home-made battery holder was found entirely satisfactory, but construction details are not given since ready-made holders for the TR-124R battery are

now available from *Acme Model Engineering* of Brooklyn, N. Y.

The input terminals of the range extender mate with the signal generator output terminals, and the range extender output terminals are the same type as the generator terminals. In this case, one of the generator accessory cables terminates in the appropriate connector. If the generator is not equipped with such a cable one can be made up, or else the input terminals on the range extender can be located so as to permit direct plug-in to the signal generator. For convenience in wiring, one of the crystal diodes in each holder is reversed so as to present one cathode and one anode terminal at the ends of the holders for modulator input and output connections. The  $L_1$  secondary is then connected to the junctions between the two holders.

The coil  $L_1$  should have a high "Q". A *Miller* type 6300 will be satisfactory between 1 and 3 mc. Depending on the frequencies involved, the *J. W. Miller* 4500 series of adjustable r.f. coils and the 6100 and 6300 series of adjustable TV width coils should be investigated for possible use.

The secondary of  $L_1$  is made by winding 20 turns of fine wire (#32 will be satisfactory) at the base of the present winding. Leave  $2\frac{1}{2}$ " leads so as to reach the modulator terminals and fasten the winding to the coil form with coil dope.

The coils used in the filter should be small low-loss units to obtain best filter action. The *J. W. Miller* phenolic and iron core single-layer chokes (4500 and 4600 series) and the *Millen* J300 series are available in values suitable for most uses. In some cases where the cut-off frequency is close to the end of the converter range, it may be necessary to buy coils of the next larger size and trim to the desired value, otherwise the nearest value of inductance will generally be satisfactory. Also it is recommended that silver mica capacitors be used in the filter and for  $C_1$  and  $C_2$ . For the 3-mc. oscillator,  $C_2$  is  $50 \mu\text{fd.}$ , but will need to be changed to a different value if the oscillator is used at a different frequency. Likewise  $C_1$  is  $50 \mu\text{fd.}$  and will need to be changed if the oscillator operates much below 1 to 1.5 mc.

After construction is completed, connect the signal generator to the input terminals and adjust its frequency to some convenient point in the range to be used. Adjust the core of  $L_1$  for maximum output and check with an oscilloscope to see that the waveform is good. This is the only adjustment that is made and now the range extender is ready to use.

If the local oscillator frequency or the range of frequencies to be amplified by  $V_2$  is above the limits of available transistors, this same basic circuit can be designed around vacuum tubes—preferably the miniature type. Also, where high output voltages are required,  $V_2$  may need to be a vacuum tube instead of a transistor.

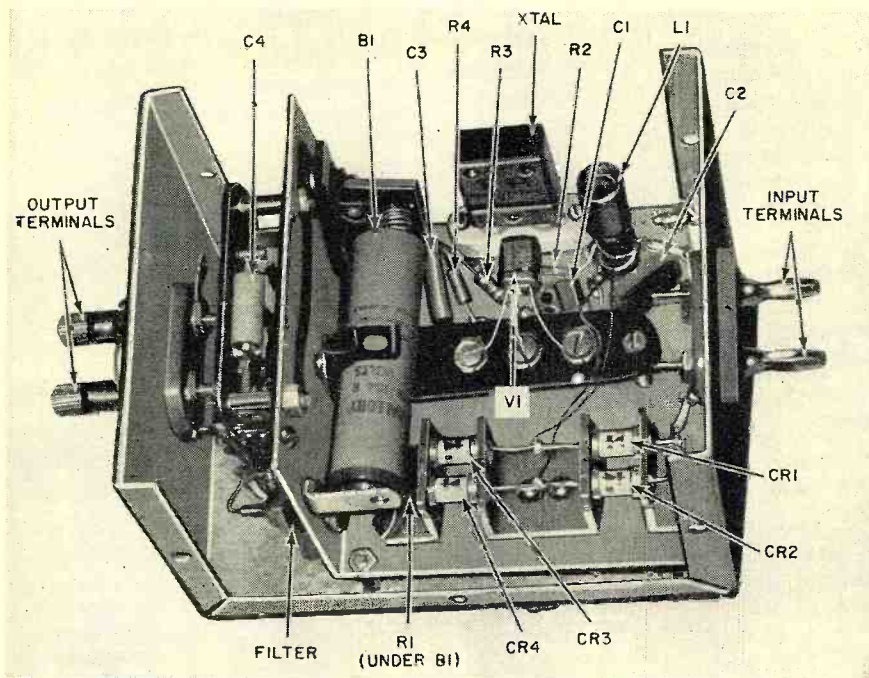
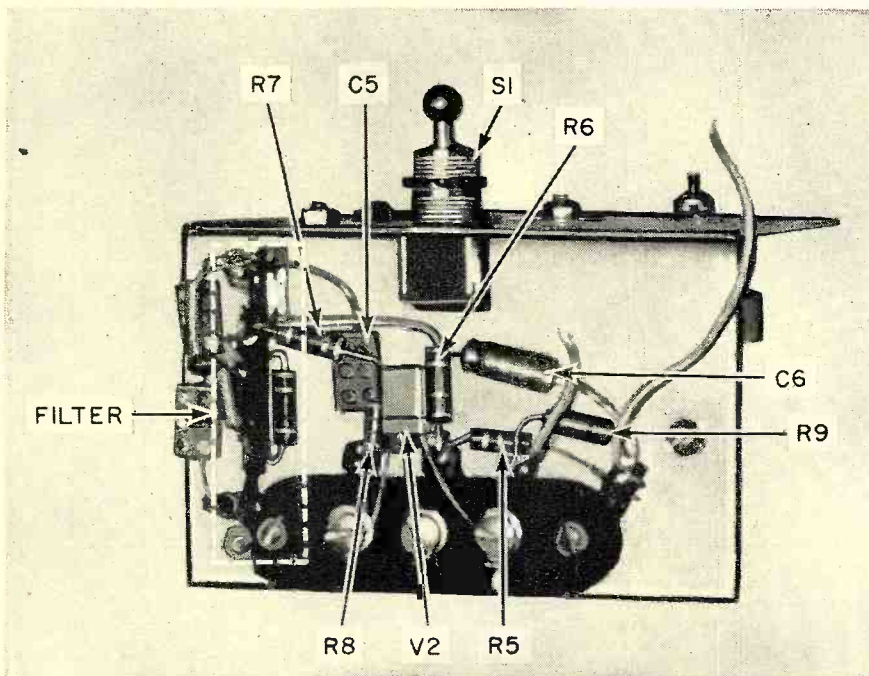

Fig. 4. Bottom view of the extender, showing parts location and mounting.

Fig. 5. View of the vertical chassis section, shown at left in Fig. 4.





# A "High Power" Portable Paging System



By **LOUIS E. GARNER, JR.**

Over-all view of the transistorized unit shows the mounting of the two trumpets.

*Multi-watt transistorized double-trumpet unit operates on self-contained batteries.*

**A**LTHOUGH once considered more or less a luxury, it is now universally acknowledged that an audio paging system is virtually a necessity in schools, in hospitals, in large business houses, in department stores, in factories, and in similar institutions and commercial or industrial establishments.

Whether used to make general announcements to the working force, to locate an important visitor, to issue instructions in case of disaster, to summon a foreman to his desk to handle a shop emergency, or to call an executive to his office to answer a long distance phone call, such a system more than pays for itself in savings of time, steps, and money.

A truly effective paging system could be just as valuable in outdoor occupations and recreation as is a conventional system indoors. For example, a high-school or college athletic coach could use such a system to give instructions to players on the practice field. Such a system could be used by foremen on construction projects, by police officers when handling large crowds, by lifeguards at swimming pools or beaches, by Civil Defense or disaster workers in field locations, or even by range-captains at shooting and archery matches. Even in such prosaic activities as a school or club picnic, a church outing, or a ham "Field Day," a portable paging

system would be valuable for calling guests to lunch, for announcing "three-legged races" or other contests, or for helping to locate lost children (or parents).

It is fairly easy to set up the basic requirements for an electronic paging system designed for general outdoor use. First, it should be completely portable and, therefore, should not require an external source of power. If battery operated, the battery life should be fairly long, with standard, readily available operating voltages to permit the instrument's operation on emergency or auxiliary power sources when necessary.

Preferably, it should be a fully self-contained system. Separate power packs, amplifier, loudspeakers, and microphones are not only a bother to transport but, with many interconnecting cables, a nuisance to install. In some cases it may be necessary to set up (or to dismantle) the system in a hurry. In addition, excessive lengths of cables and connecting lines could prove dangerous in many locations.

The system should be ruggedly constructed and reliable in operation. Unexpected failure due to a "blown tube" cannot be tolerated and a user should not be expected to carry unlimited "spare parts" with him. Such a system should not be overly expensive, either in initial purchase (or construction) or to operate and maintain. Finally, such a system should deliver enough audio power, permitting it to cover reasonably sized outdoor areas where a moderate amount of background noise may be present.

With these tentative "specifica-

tions," we can easily evaluate a prospective paging system. Transistorized equipment will not "fit the bill" if we think in terms of subminiature transistors; the power needed is measured in *watts*, not *milliwatts*.

What is needed, basically, is a multi-watt transistorized system which operates on self-contained 6- or 12-volt batteries (alternate power sources are readily available for either of these "standard" voltages); which uses power only when in operation (thus conserving battery life); which is completely self-contained, including the loudspeaker(s), microphone, and amplifier in a single unit; and which is relatively inexpensive (if available and purchased commercially); or which is easy to assemble from standard, readily available components. Such a system is shown in the photographs, while the complete schematic wiring diagram is given in Fig. 1.

## Circuit Description

Referring to the schematic diagram, we see that the complete paging system consists of a 12-volt battery power pack, a microphone, a transistorized audio amplifier, and a pair of efficient sound reproducing units. This entire system is assembled as a single easy-to-carry, easy-to-store, and easy-to-operate unit.

The amplifier itself employs two RCA type 2N301 *p-n-p* power transistors in a class B push-pull circuit using the common-emitter configuration. This amplifier is driven by the relatively high output of a good quality communications-type carbon microphone and, in turn, is easily capa-



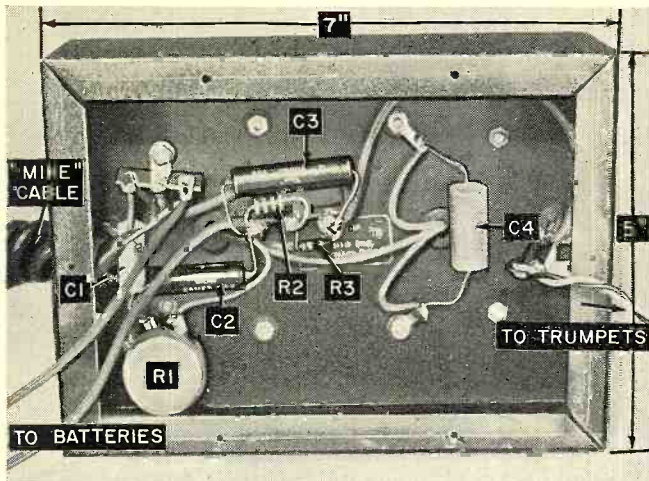

Bottom view of the smaller center chassis which mounts the transistors and the transformers. All components shown are clearly labeled here.

ble of driving the pair of paging trumpets to their full output rating. Transformer coupling is used throughout.

In operation, a s.p.s.t. "push-to-talk" switch ( $S_1$ ) in the microphone serves as the main on-off switch for the entire system. Thus, no "stand-by" power is needed and battery power is used only while the unit is in actual operation. This, coupled with the high efficiency of the class B power amplifier, extends the battery life. Under normal operating conditions, the battery life should closely approach the "shelf life" of the batteries specified.

With switch  $S_1$  closed, the positive terminal of the battery power pack ( $B_1$  and  $B_2$ ) is connected to circuit ground, closing the amplifier's d.c. circuit and permitting operation. The d.c. microphone current flows from the battery, through the microphone's cartridge, through the primary winding

of input transformer  $T_1$ , through the adjustable current-limiting resistor  $R_1$ , and back to the battery. A large capacitor ( $C_3$ ) serves to bypass the power supply and switching circuits and thus minimize the adverse effects of switching transients on amplifier or transistor operation.

Since  $R_1$  can be adjusted to vary the microphone's current, it serves as a semi-fixed volume or sensitivity control. Normally, it is adjusted for optimum operation when the system is initially tested and "set up" and is then left in a fixed position unless there are considerable changes in external operating conditions under which the system is used.  $R_1$  is bypassed by a fairly large electrolytic capacitor ( $C_2$ ) to prevent the attenuation of audio signals by this component.

The alternate compression and re-

lease of carbon granules in the microphone's cartridge as sound waves strike its diaphragm results in corresponding changes in the microphone's steady current, developing an audio signal across  $T_1$ 's primary winding. Although the high quality unit used develops relatively little of the "carbon hiss" normally associated with this type of microphone, what noise may be present is effectively bypassed across the transformer's primary winding by capacitor  $C_1$ .

Input transformer  $T_1$  serves a dual purpose. It not only matches the source impedance of the carbon microphone to the input impedance of the transistor amplifier but, by virtue of its center-tapped secondary winding, supplies the two 180° out-of-phase signals essential to driving the push-pull circuit.

In order to insure stable circuit operation, the small base bias current required by transistors operating as class B amplifiers is supplied by a voltage divider consisting of resistors  $R_2$  and  $R_3$ .

Output transformer  $T_2$  matches the moderate output impedance of the transistor amplifier to the relatively low impedance of the two paging trumpet voice coils connected in parallel, assuring maximum power transfer to the trumpets and minimum signal distortion. A collector-to-collector bypass capacitor ( $C_4$ ) minimizes the effects of whatever harmonic distortion is introduced by the amplifier stage itself.

### Construction Hints

Using standard, readily available components, the paging system can be assembled in two or three evenings or on a single weekend by any competent electronics technician or hobbyist who has had experience assembling amplifiers and receivers in the past. A rank beginner, on the other hand, would probably prefer to tackle a few simpler projects before attempting construction of this unit.

With neither parts layout nor lead dress critical, the builder can either follow the general layout of the model shown in the photographs or can make up a new layout to suit his own requirements. If a new layout is made,

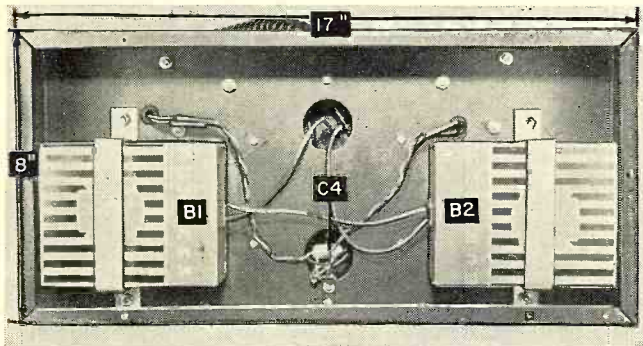

Bottom view of the larger over-all chassis is shown here. The mounting of the two heavy duty 6-volt batteries may be seen in the photo.

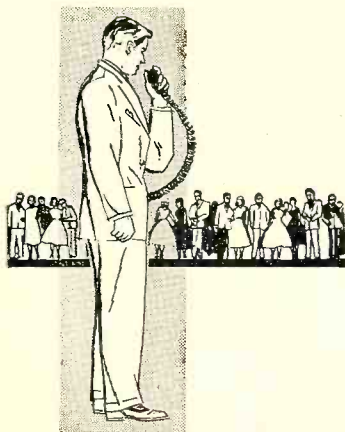

Top view of the transistorized paging system is shown here. Note how each transistor is mounted on its own heat sink. The sensitivity adjustment  $R_1$  is accessible from the top. Note also how the trumpets are angled outward for better coverage.

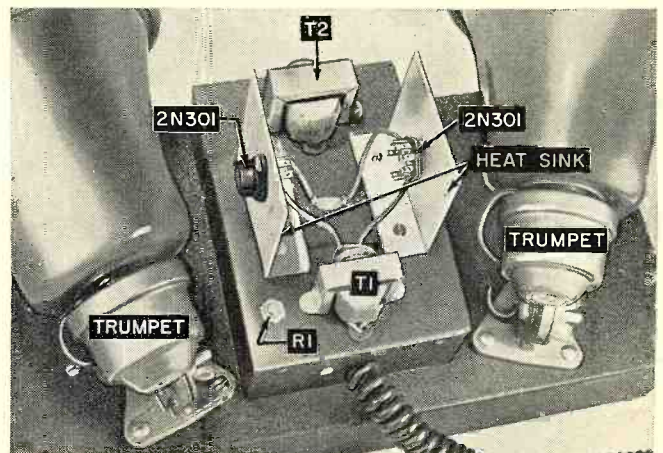



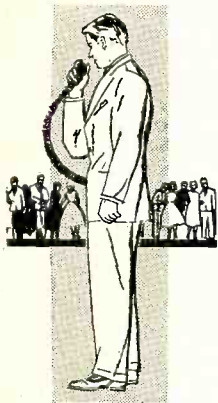
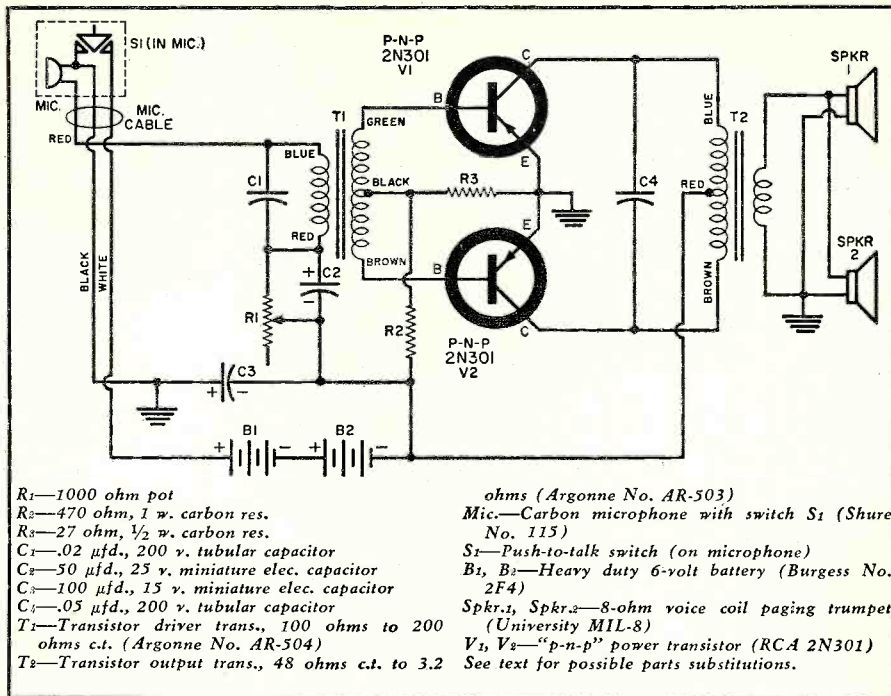

Fig. 1. Complete schematic diagram and parts listing for the portable paging system described here. Two "p-n-p" power transistors are used in a class B push-pull circuit.



“good wiring practice” should be observed, however. That is, the amplifier’s “input” and “output” circuits should be kept well separated and the two audio transformers should either be kept well separated or, if mounted close together, should be positioned so that the cores are at right angles to each other. This positioning will minimize the possibility of magnetic coupling between closely spaced iron core transformers.

In the author’s model, a unique “two-chassis” construction is employed. The transistor amplifier is assembled on a small standard “amplifier foundation” and this subassembly, in turn, is mounted on a relatively large metal chassis which serves both as a container for the battery power pack and as a mounting base for the two University MIL-8 paging trumpets. The two trumpet loudspeakers are mounted on either side of the amplifier chassis and set at a slight angle to obtain increased horizontal coverage.

The two RCA power transistors are mounted on small aluminum sub-chassis which serve as heat sinks. Although the actual size of these two sub-chassis is not too important, they must be insulated from each other and from the main chassis, which serves as circuit ground. In the model, this was accomplished by using fiber shoulder and flat washers to insulate the sub-chassis mounting screws.

There are several points that should be checked as the amplifier is wired. All battery and electrolytic capacitor polarities must be observed. Care should be taken to check the color-coding of the audio transformers (*T*<sub>1</sub> and *T*<sub>2</sub>) and the Shure microphone leads.

Proper loudspeaker phasing is extremely important to insure that the sound produced by the two units reinforces rather than cancels. Since the two University trumpets are connected in parallel, correct phasing is obtained when corresponding input terminals (or color-coded leads) are connected together and to the output transformer’s secondary winding.

Since the completed system will be used in portable applications, it will be subject to considerable vibration and

traveling shock. Hence, good mechanical construction is essential. All connections should be mechanically secure before they are soldered. Protective rubber grommets should be used wherever wires or cables are passed through small holes in the chassis. Finally, lockwashers should be used on all machine screws.

A small metal bracket should be provided to hold the microphone when not in use. The round construction of the Shure type 115 microphone used in the model makes it ideal for bracket mounting. A suitable bracket may be hand-formed from a stray scrap of half-hard sheet aluminum, a piece of flat brass, or from phosphor bronze or even steel, provided it has a certain amount of “springiness.” The exact shape or size of the bracket is not too important as long as it holds the microphone securely and the individual builder may wish to exercise his own design ingenuity in working out a suitable unit.

Since the 6-volt batteries used to power the system are moderately heavy, a secure mounting arrangement must be used for these two com-

ponents. Suitable “heavy duty” mounting straps may be formed to fit the batteries out of 3/8" thick by 1" wide aluminum bar stock.

**Circuit modifications and parts substitutions:** Although the components used in the author’s model and specified in the parts list were carefully chosen during the design of the instrument, a number of parts substitutions may be made with a minimum effect on over-all system performance. Often, by the selective substitution of “on hand” parts for specified components, the individual builder can reduce the cost appreciably.

First, of course, conventional cone-type loudspeakers or other types of paging trumpets may be substituted for the MIL-8’s. A good alternate choice is University’s CMIL-8 “cobra” type trumpets. If cone-type loudspeakers are used, the builder should remember that conventional loudspeakers, as a general rule, are not as efficient as trumpet-driver combinations; that is, less of the available electrical power is converted into sound energy by such units.

(Continued on page 112)

Here is how the microphone is mounted on a bracket that is located on the back of the top cover of the portable unit. A handle is mounted on top of the cover for easy carrying.

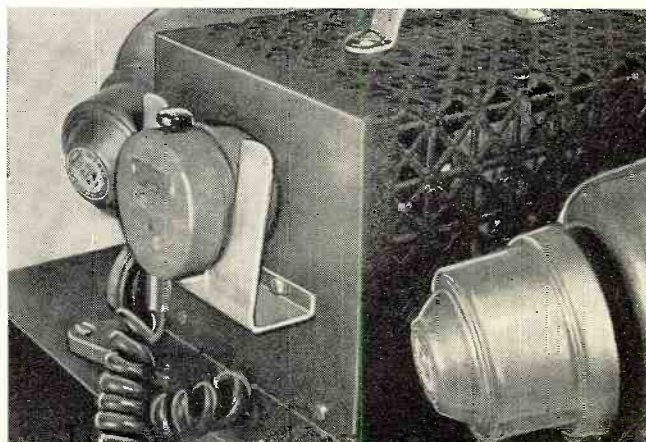



# Adding 2 mc. to the Off-Center-Fed Antenna

By DR. R. G. MINARIK, W9GJY

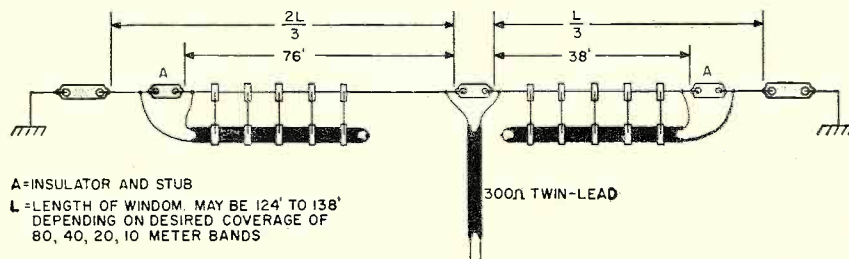
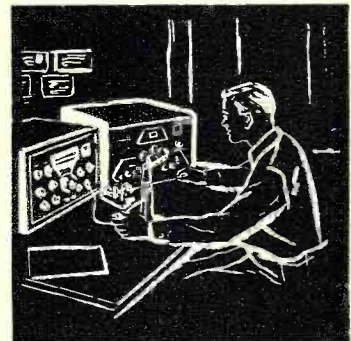

Fig. 1. Modification of the antenna for 21-mc. coverage is shown in this figure.



*Adding just 2 insulators and 2 shorted stubs converts the "Windom" to a five-band long wire.*

ARTICLES concerned with the "Windom" all-band antenna have appeared in this magazine over the past few years. First was the "3-band wire" (June, 1954), then came the "4-band wire" (December, 1956), but neither had provision for loading on 21 mc. With the addition of just two insulators and two shorted quarter-wave stubs to the off-center-fed antenna (December, 1956), it is possible to have a "5-band wire" covering 80, 40, 20, 10, and 15 meters.

The difficulty encountered in loading the customary "Windom" on 21 mc. arises from the fact that the standing-wave pattern on this band results in a very high impedance where the 300-ohm feedline is attached.

A suitable off-center antenna for 21 mc., with approximately 300-ohm feedpoint impedance, could be constructed of a wire five halfwaves long (114 feet for mid-band) and fed at the

third point with twin-lead. Such an antenna would result if 7 feet were cut from the short section and 14 feet were cut from the long section of a regular 135-foot long "Windom." This shortening can be done automatically through the action of resonant 21 mc. quarter-wave shorted stubs placed at the "cutting" points. The stubs behave as insulators on the 21 mc. band and as conductors on all other bands.

To modify a "Windom" to include 21 mc. coverage, simply add two insulators and two quarter-wave stubs as shown in Fig. 1. The method of placing the insulators is obvious. The construction of the stubs merits more detailed explanation.

The shorted quarter-wave stubs (or traps) are made from 300-ohm twin-lead—preferably the filled tubular type such as *Belden "Celluline."* Cut a 12-foot length and solder the conductors together at one end. At the

other end, shave the outside insulation from each wire for a distance of about 6 inches and pull the wires outward as shown in Fig. 3. Do not cut away the remaining center insulation "X" as it is useful in anchoring the stub to the antenna.

Place a grid-dip oscillator at the shorted end and determine the resonant frequency of the line. It should be well below 21 mc. Using this frequency as a guide, pull both free leads through the insulation (new position shown dotted) an inch or so at a time until the line dips at 21.2 mc. It is advisable to keep the grid-dip oscillator coupled as loosely as possible to avoid frequency "pulling." Also, the free leads should be clipped as they are pulled so that they have a constant exposed perpendicular length of about 6 inches.

With this stub completed, the second is made as a "Chinese copy" without repeating the cut-and-try procedure all over again. Both stubs then resonate at the same frequency.

The writer has used the arrangement shown in Fig. 4 for attaching the stubs to his antenna. Fig. 2 shows an effective way of using a TV stand-off to relieve strain on the feedline connection and to keep the line from winding up on the center insulator.

This 5-band wire has performed very satisfactorily at the author's station and landed a VS6 on 21 mc. It is fed through a *Johnson "Matchbox"* which easily tunes out the reactive components of the impedance (yes, "Windoms" are reactive) and keeps the s.w.r. seen by the pi output transmitter at a very low value on all phone and c.w. bands—including 21 mc.

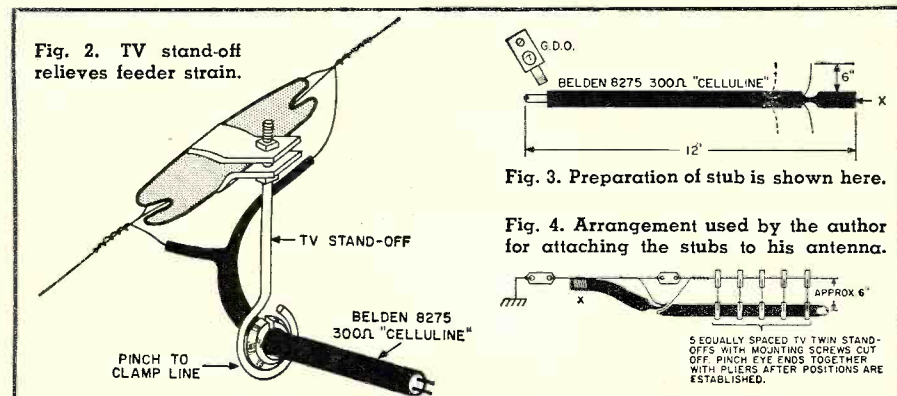



# The Gremlin Sentry

## —an Automatic Control Switch

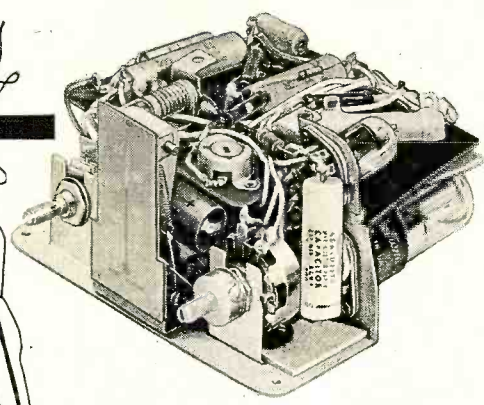
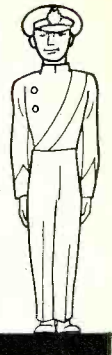

By  
**ROBERT LANDIS**  
Bendix Radio

Here are the insides of the blanket control unit.

**H**AVE you ever wanted a trained gremlin to hang from a skyhook over an important switch and yell his head off when it needed throwing? Or, better yet, to throw it to the proper position himself? Would you like your gremlin to be able to feel heat, see light, sense proximity, or be allergic to raindrops? Would you like to have an inexpensive, ready-built basic gremlin which can quickly and easily be trained for any of the above tasks? (All this without the aid of transistors!) Read on; this article was written for you.

The basic unit is a surplus electric blanket control widely advertised as a "thyatron" control—(Simmons Electronic Blanket Control, Style AC-1). The thyatron, however, is used only as a fancy fuse and plays no part in tripping the relay!

What it really did as a blanket control was to stand guard over the person sleeping under the blanket. In case of a dangerous circuit fault which otherwise would cause the blanket to overheat, this valiant sentry made the supreme sacrifice, thus removing all power from the diabolical device. Instead of waking up toasted to a golden brown, the unsuspecting victim of this electronic booby-trap slumbered peacefully on until he was chilled to the bone and pneumonia was a dead certainty.

The first step in converting the unit is to replace the \$3.00 "fuse" (the thyatron) with a piece of wire soldered between pins 2 and 5 of the miniature tube socket. (Squeamish or sane experimenters may use a fuse instead of the wire.)

Step 2 is to remove the 0.24-ohm resistor ( $R_s$ ) and replace it with a short length of insulated wire. This step is important in preserving the basic sensitivity of the unit.

*Versatile control unit can be made to feel heat, see light, sense proximity, or to feel raindrops.*

Next, connect the line cord to pins 1 and 3 of the 5-prong plug. Pins 2 and 4 may be connected to any 117-volt resistive load, up to 200 watts, that you wish to control. If the unit is to switch larger currents or inductive loads, connect pins 2 and 4 to the coil of a 117-volt a.c. relay whose contacts are rated at or above the desired load. Those heavier contacts are then connected in series with the load and a separate line cord or other power source.

At this stage, the control is merely

a plate relay, fed by a three-stage amplifier with a balanced bridge input. See Fig. 5. Further alterations will be confined to the input bridge.

### Temperature Control

Since the unit was originally a temperature control, this conversion will be considered first.

With a temperature-sensitive element connected to the input bridge, and the relay controlling the current through a heating element, the unit is an automatic temperature stabilizer with a sensitivity of about 1°C. In this case, the sensitive element is merely a piece of wire wound on a suitable framework. This unimpressive component is called a "resistance thermometer." Since the resistance of a wire varies with temperature, this change in resistance may be used to detect a change in temperature. The resistance change, in turn, is used to unbalance a bridge circuit and produce a signal voltage. This voltage, suitably amplified, is used to actuate a relay driver. The relay is used to turn a heating element on and off. Certainly this is a busy and talented gremlin. He is constantly measuring a variable quantity (temperature), making a judgment (high or low), and performing the desired function (on-off switch) as required.

Without further ado, you can complete the temperature control by connecting a 1350-ohm "resistance thermometer" and a 200-watt, 117-volt heating element. See Fig. 1. Unfortunately, 1350 ohms leads to an unpleasantly long piece of wire and a somewhat unwieldy supporting frame-

PR. VOLTS	SEC. VOLTS	R <sub>s</sub> OHMS
115	2.5	0.64
115	6.3	4
115	12.6	16
115	25	64
115	50	255
115	115	1350

(Secondary Volts)<sup>2</sup> / (Primary Volts) × 1350 = R<sub>s</sub>

Table 1. Transformers and load resistors.

Table 2. Temperature coefficients of wires.

WIRE	TEMP. COEFF.
Aluminum	0.004
Brass	0.002 (variable)
Copper	0.0039
Iron	0.0056
Nichrome	0.00017
Nickel	0.0047
Platinum	0.0038
Silver	0.004
Tungsten	0.0045

R =  $R_0 (1 + \alpha T)$   
R = resistance at temperature to be used.  
R<sub>0</sub> = resistance at room temperature.  
α = temperature coefficient.  
T = difference in °C between room temperature and the temperature at which the resistance thermometer is to be used.  
Note: If it is more convenient to use T in °F, multiply the temperature coefficient by 5/9.



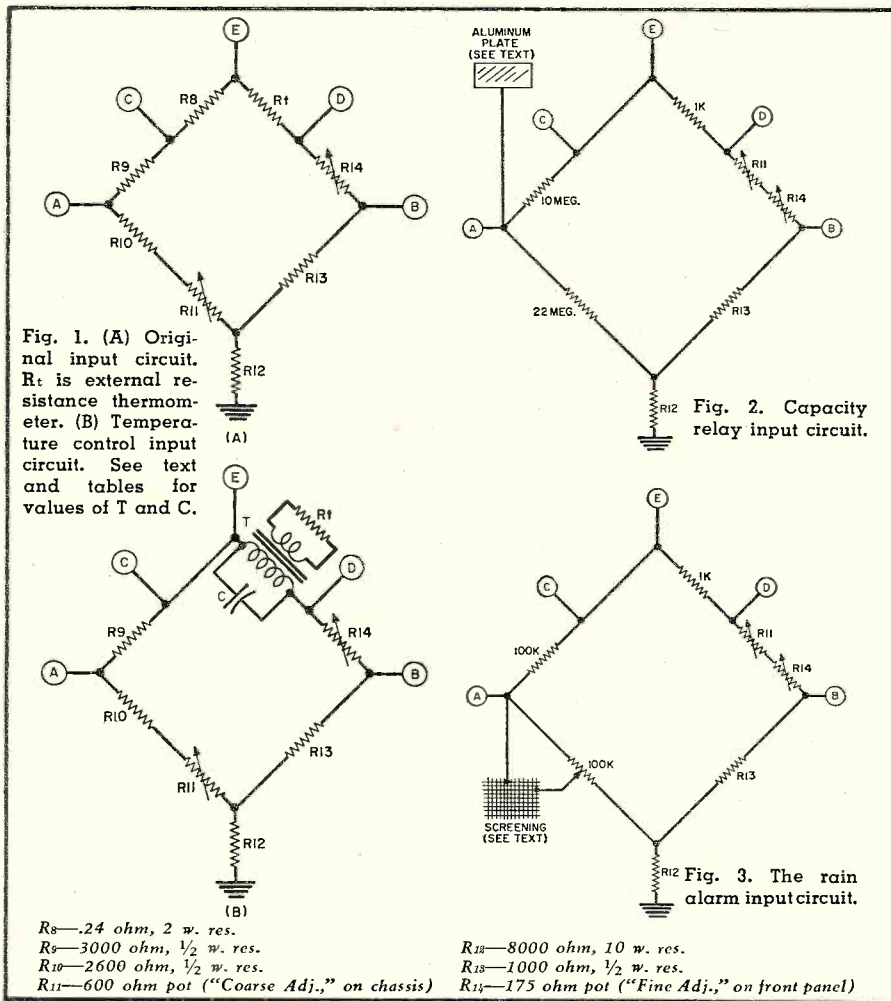

work. Added to this, there is a possibility of shock since one side of the thermometer is connected directly to the power line. Both of these birds are killed with the same stone: a transformer. This provides both the isolation from the line and the necessary impedance matching to get to a reasonable length of wire. In fact, when using a 2.5 volt filament transformer, the requirements are met by about 1 foot of #30 iron wire. This length of wire will not even require a supporting framework. See Fig. 1B. Other transformers and lengths of wire may be used. See Tables 1 and 2.

A capacitor must be placed across the primary of the transformer or the sensitivity will suffer. The value of this capacitor depends on the transformer used and will usually be between 0.01 and 0.5 microfarad. Trial and error is the easiest way to determine this capacity. To obtain the greatest sensitivity, iron or nickel wire is commonly used for the resistance thermometer because of its comparatively large change in resistance. Wire made of other materials could be used, provided the total resistance is correct. Almost any other common metal or alloy used for wire will reduce the sensitivity of the control. This reduction could be very desirable in some applications. The greater the over-all sensitivity of the unit, the more often it will turn the

relay on and off. If very close temperature control is not needed, its only effect will be to shorten the life of the relay contacts.

For those who wish to get all tangled up in the mathematics of this simple little gadget, the required constants and formula are supplied in Table 2. As a rule of thumb, the higher the temperature coefficient of the wire, the more sensitive the control.

To further confuse the issue, here is an easier way to lower the sensitivity: Replace part of the resistance thermometer with a fixed resistor. The reduction is proportional to the portion of the thermometer replaced. Don't try to put a rheostat at this point in the circuit to be used as a variable sensitivity control. This it would do, but it would also vary the temperature setting. Needless to say, such interaction of controls is very undesirable.

Some "cut and try" may be necessary to get a length of wire whose resistance can be brought within the range of the fine control by the coarse adjustment. Start with a wire which is surely too long. Each cut should remove no more than 10% of the remaining wire.

The leads from the control unit to the resistance thermometer should have negligible resistance compared to the temperature sensitive element.

Throughout any of these changes, the total effective resistance of this section of the bridge circuit must remain close to 1350 ohms. This holds true for any type of wire, any resistor and wire combination, and even for the transformers and resistances of Table 1 (except as mentioned in the next paragraph).

A third way of varying the sensitivity is usable with the circuit of Fig. 1B. Changing the value of capacitor *C* will give a wide range of adjustment. (Do not use an electrolytic.) Some combinations of transformers and capacitors may require a different value of *R<sub>t</sub>* than given in Table 1. (Cut and try, try again.)

In case you're wondering what was done about reducing sensitivity in the original circuit, here is the interesting, but useless, information. Remember the 0.24-ohm resistor (*R<sub>s</sub>*) which was deleted? A look at the schematic and the original input circuit will show that the current to the heating element passed through *R<sub>s</sub>*. This resistor was part of the input bridge. Any current drawn by the controlled load caused a voltage drop across the resistor, which further removed the voltage between *A* and *B* from the relay release point. The controlling element had to overcome this unbalance in addition to coping with the normal difference between bridge voltages at the pickup and release points of the relay.

This system has the obvious disadvantage that the sensitivity will depend on the current drawn by the controlled load.

The "Blanket Temperature" scale on the front must be recalibrated. Use the 600-ohm "Coarse" adjust, *R<sub>11</sub>*, to choose the portion of the range you wish to cover with the 175-ohm "Fine" adjust, *R<sub>14</sub>*. The "Very Coarse" adjustment is the resistance of the thermometer itself. This unit has an inherent time delay of approximately 1/2 sec., so move the controls slowly or inaccurate calibration will result.

Obtain a thermometer whose scale includes the range you wish to cover with the "Fine" control. Place the standard and resistance thermometers close together in any enclosure where you can control the heat and read the standard thermometer. Set the temperature of the enclosure at the midpoint of the desired range. Adjust the "Coarse" and "Very Coarse" controls until the relay closes when the "Fine" control is moved slowly to mid-range. Mark this point and obtain two more points; one near each end of the scale. Since the calibration curve will be linear, only these three points and a pair of dividers will be needed to lay out the scale.

With this hook-up, decreasing temperature will energize the relay. If it is desired to close a circuit when the temperature increases, connect the controlled power output to a 117-volt, 60-cycle relay whose normally closed contacts are wired in series with its



power source and the controlled load.

A more economical way to obtain a closing relay with increasing temperature would be to re-arrange the components of the input bridge. (This will probably work, but it hasn't been tried.)

The use of this temperature control is not limited to ordinary temperatures. The upper limit is the point at which the wire used for the resistance thermometer begins to change, e.g., melt, oxidize, etc. The lower limit need not concern you. You will never reach it.

The circuit is only mildly sensitive to line voltage changes. With the bridge balance set half way between the pick-up and release points at a line voltage of 110 volts, an increase to 115 volts will cause the relay to close and a decrease to 105 volts will open it. Since a 10-volt change will produce an error of only 1°C, this is not a serious matter for most applications.

Speaking of applications, next summer you might try using this gadget to turn off an exhaust fan when the indoor temperature drops to the point where the breeze is no longer needed. Although the fan will give pleasant relief during the sweltering early evening hours, it may give you your death of cold if left on in the cool early morning hours.

### Capacity Relay

In its most common form, a capacity relay is an oscillator circuit which loads down and stops oscillating upon the approach of a large mass. The resultant current change trips a relay. It just so happens that the gremlin doesn't work that way. Those who have worked with audio amplifiers know that your hand can cause "hum" in the output when brought close to a high impedance grid lead. This is due to capacitive coupling between your hand and the wire. In this case, your body is acting as a 60-cycle antenna. Unless you happen to be several hundred feet tall, you are an inefficient antenna at this low frequency, but sufficient signal can be picked up to unbalance a high-impedance bridge. Fig. 2 shows the converted input bridge. The aluminum plate was connected to the bridge by a 2-foot length of wire. Set the controls so that the relay is on the verge of closing. The relay will trip when your hand comes within about 6 inches of the plate. The line plug polarity is critical in this application. Reversing the line plug may make the difference between proper operation and no results. Using a larger aluminum plate (or piece of kitchen aluminum foil) will give the unit greater sensitivity. The larger plate may require changing the relative values of the 10- and 22-megohm resistors. The values must be kept high or the sensitivity will suffer.

Since everyone is so thoroughly familiar with the unlimited, useful, and interesting applications of capacity relays, we won't bother to enu-

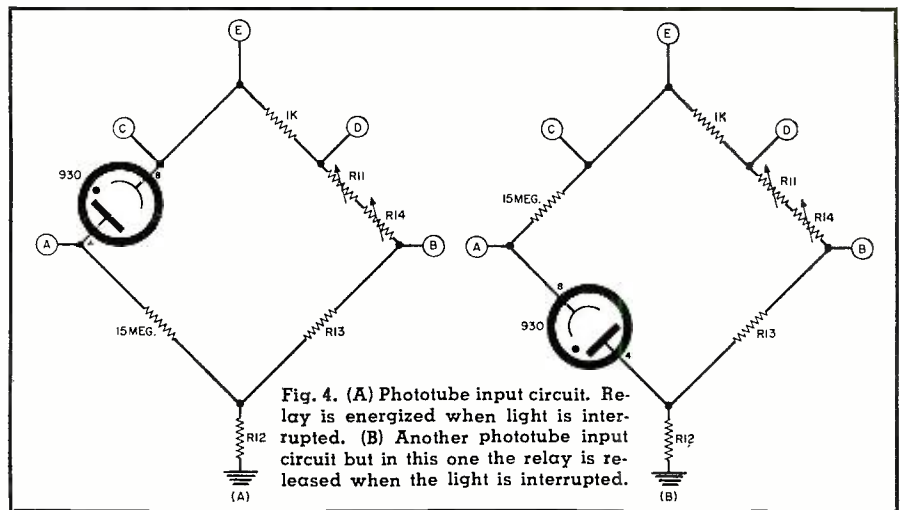

Fig. 4. (A) Phototube input circuit. Relay is energized when light is interrupted. (B) Another phototube input circuit but in this one the relay is released when the light is interrupted.

merate them at this particular point.

### Light Relay

A light relay is actuated by a change in the light intensity falling on a sensitive element. In this case, the change in light causes a change in the internal resistance of a phototube. This change in resistance is used to unbalance the input bridge. The actual conversion is a light task, as shown in Figs. 4A and 4B.

Although a type 930 tube was used in the test, other types could probably be substituted by changing the 15-megohm resistor. Line-plug polarity is critical here and seems to be in all cases where high-resistance elements are used in the bridge. No special light source was used for this test. The unit was adjusted so that a shadow, cast by normal room lighting, would cause the relay to trip. Note that by interchanging the circuit positions of the tube and the resistor, the unit is changed from a normally open to a normally closed relay switch.

For a deluxe set-up, you could pro-

vide a special light source to remove dependence upon room lighting or daylight. You could add focusing lenses to increase its range. A short tube used as a shroud over the phototube would reduce unwanted tripping by stray light and reflections. You may use filters and/or special light sources to reduce the effect of stray light. Before going off the deep end and building a fancy, expensive set-up, check the band of wavelengths to which the phototube you wish to use is sensitive. A phototube sensitive only to blue light and an infrared light source will give very disappointing performance. It won't work.

A suggested application for this conversion is a sunset light switch. When darkness falls, the light goes on. Wouldn't it be nice to return home after dark and find that your pet gremlin had turned on the porch light for you?

### Rain Alarm

Basically, a rain alarm is something  
(Continued on page 120)

Fig. 5. Complete schematic diagram and parts listing of the blanket control unit.

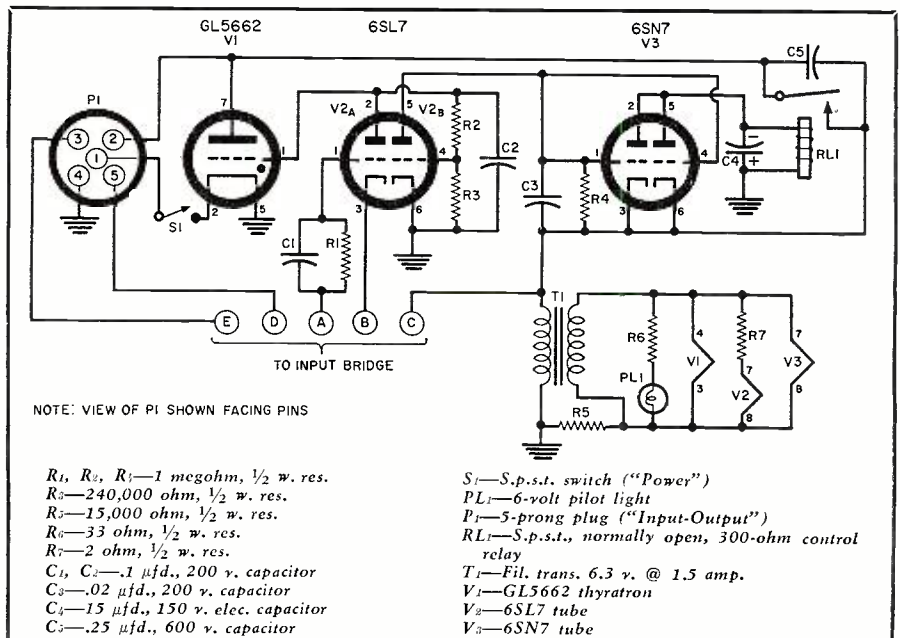



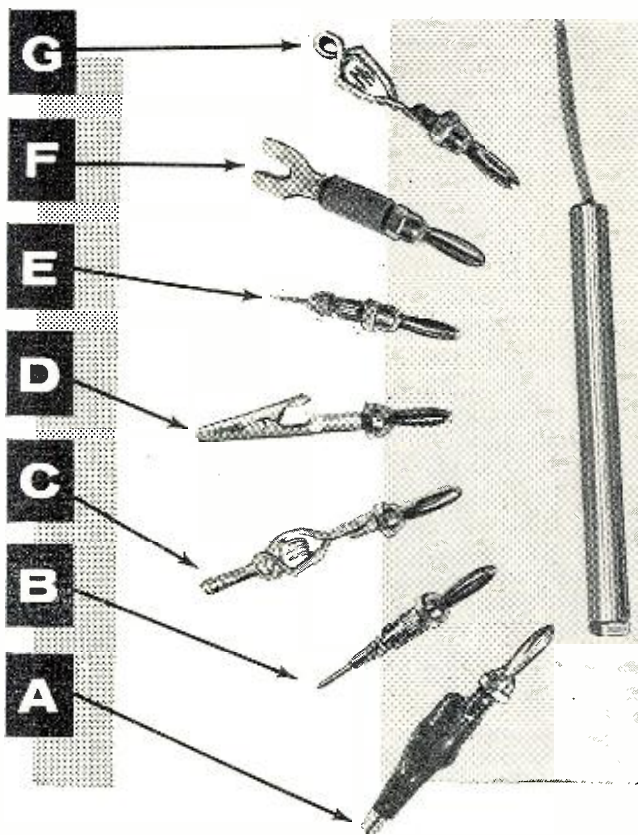

# Universa Test Leads

Fig. 1. These are just some of the plug-in connectors that can be made up.

By TRACY DIERS

*Why waste time making connections? Adapt your leads to take any plug-in connector in a jiffy.*

TEST LEADS for multimeters and v.t.v.m.'s usually can be purchased with only one type of termination—for example, alligator clips or battery clips or phone tips. This limits the usefulness of a set of leads to one type of application.

Here is a simple, inexpensive way to convert your present leads so that they may take a wider range of terminations, thus making it possible for you to use your meter under many different conditions. Best of all, the conversion can often be accomplished with junk-box parts.

Your present test leads may terminate in phono needles, phone tips or the like. The first thing to do is remove the termination from the insulated handle. This can be done with a pair of pliers, as shown in Fig. 2. If the original tip won't come out easily, just cut it off with a hack saw.

The insulated handles of most test

leads are approximately 1/4-inch inside diameter. Pass the flexible wire from your meter through the insulated handle and solder a 1/4-inch banana jack to the wire, as in Fig. 3. Pull the wire back through the insulated handle and force the banana jack into the end of the handle, letting it form its own thread as it is turned in. If the openings in your test-lead handles are slightly larger than the jack, use one of the general-purpose cements to hold the latter in place. If the jack should be too large for the handle, drill out the opening in the handle to accept the jack.

After the handles are prepared you may either make all the attachments at once, or as you need them. Fig. 1 shows some of the attachments possible. All of these attachments are coupled to a spring-type banana plug whose over-all length is 1 3/8 inches. These banana plugs have a 6-32 stud.

Referring to Fig. 1 again, these are some of the attachments:

*A* is an insulated alligator clip, useful for making self-holding connections when high voltage can't be turned off. Attach the banana plug by soldering it firmly to the stud. Crimp the ends of the clip over the stud.

*B* is a phone tip, useful for taking readings where only tip jacks are available for self-holding connections. Attach the banana plug by soldering the stud into the back of the phone tip.

*C* is an uninsulated crocodile clip, useful for grasping large objects where high voltage can first be turned off. Attach the banana plug as shown in *A*.

*D* is an alligator clip, uninsulated, for self-holding connections to very small spots when high voltage can first be turned off. Attach banana plug as in *A*.

*E* is a phono needle probe, for momentary contact to slippery spots, high voltage on or off. Attach banana plug by inserting stud in hole in back of phono needle holder. Solder all

*(Continued on page 121)*

Fig. 2. Removal of a test lead's original termination.

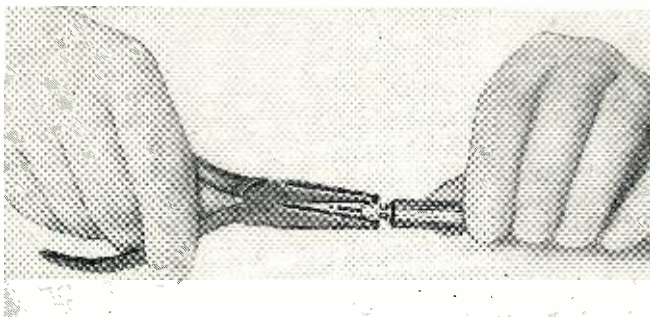
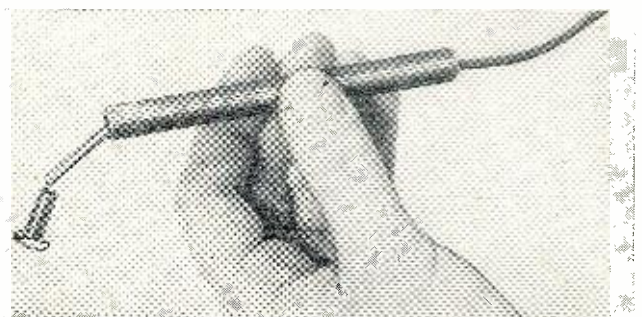

Fig. 3. Banana jack is wired to lead and fitted to handle.





# New Compatible Stereo Disc

By MILTON S. SNITZER  
Technical Editor

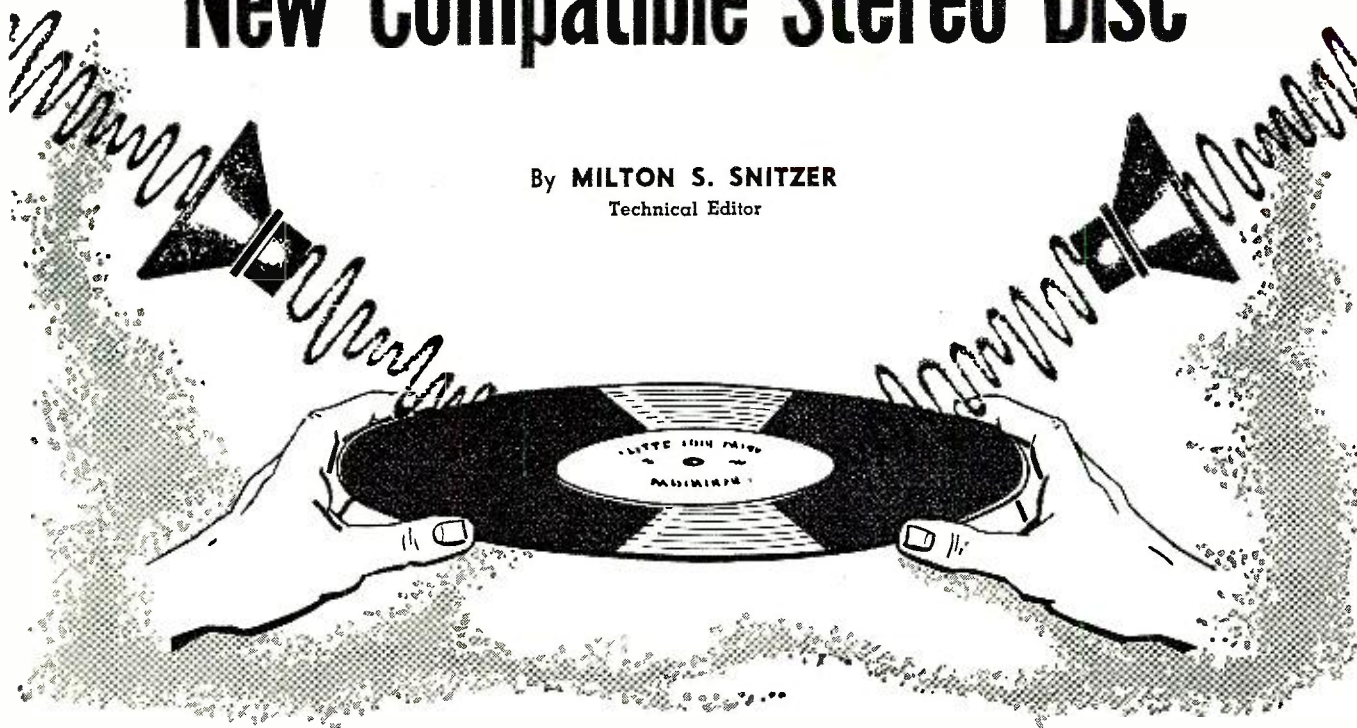

*CBS disc can be played on ordinary monaural phonos without damage. Uses lateral-vertical recording.*

THE father of the modern LP record, Peter C. Goldmark, president of CBS Laboratories, has just unveiled another whopper. While the RIAA Engineering Committee was making its report at an industry board meeting which everyone assumed would lead to the adoption of the Westrex 45/45 stereo system, a very significant paper was being read at the 1958 IRE National Convention. This paper, by Goldmark, Ben Bauer, and Wm. Bachman, was called "The Columbia Compatible Stereophonic Record." It introduced a completely compatible stereo disc.

The new disc records two sound tracks in a single groove. When these are applied to separate amplifiers and speaker systems, a full stereo effect is produced. But equally important, if the record is played on an ordinary monaural phono, the vertical undulations of the groove will not be plowed up and the record will not be damaged. This cannot be said of records using the ordinary 45/45 system of recording proposed for stereo. With this latter system, the ordinary monaural cartridge, with its greater vertical stiffness, might very well ruin the record. Of course, the sound produced by a conventional cartridge will not be stereo sound. Special pickups, along with an additional amplifier and speaker would be needed for this. But with the CBS record, the consumer is allowed to graduate slowly to stereo. His present equipment will not be made obsolete as he will be able to buy and play stereo records with his present monaural equipment. These same records will then produce a stereo output when he is ready to upgrade his system to stereo.

Even if the 45/45 system is accepted as an industry standard, this would not necessarily affect the new CBS development. This is because the 45/45 system may be considered as one special case of the CBS system. It appears, then, that any recommendations or requirements adopted by the industry as a whole might be met by the new compatible system.

The compatible stereo records, when played with existing monaural pickups, have the same level and sound quality as standard LP's. What is more, the same record wear, stylus wear, and playing times are achieved. For stereo playback, either a 45/45 type pickup or a horizontal-vertical type can be used. The only difference is in the way the pickup outputs or speaker outputs are interconnected.

## How It Works

In the new record, the left and right channels at the original recording session are combined into a sum

channel and a difference channel. The sum signal, obtained by simply adding together the left and right channels, is recorded laterally on the disc groove. This signal then is in the groove exactly the same way that standard LP's are recorded and the sum signal contains all the significant information now on the regular LP. The difference signal, obtained by subtracting the left and right channels, is recorded vertically. It is this difference signal that carries the spatial information required for stereo.

When two identical channels are reproduced over two speakers, the sound seems to come from a point midway between them—this is monaural reproduction. Only when the two channels differ from each other do we produce stereo effects. Hence it is the difference between the two channels properly combined with the sum signal which produces stereo.

In the new system, the vertical motion of the groove is restricted so that it never exceeds one-eighth of the maximum lateral swing. (See illustration.) However, at low recorded levels as well as at certain frequencies the lateral swing is much reduced, and it may have the same amplitude as the vertical motion. In these cases the resultant motion is at 45 degrees with respect to the record surface.

The restriction on vertical motion just described is essential if existing monaural pickups are to be used. These pickups usually have a vertical

*(Continued on page 114)*

Cross-section of groove on the new disc.

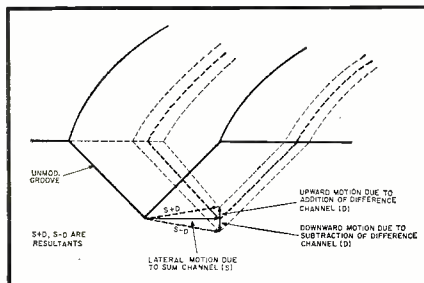



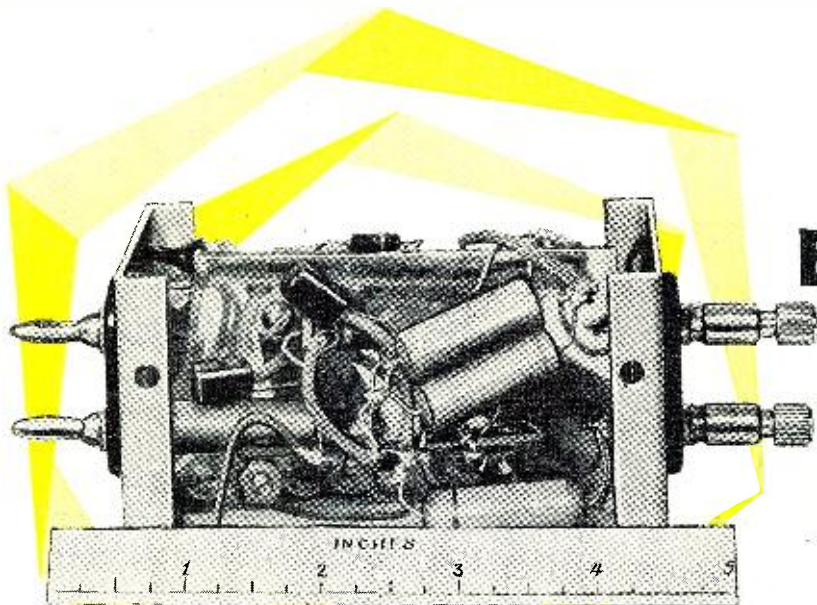

Fig. 1. An aluminum box 4 inches long houses the entire signal-booster unit.

# Boost Your Scope's Sensitivity

By PAUL S. LEDERER

*With a transistorized preamp that plugs into the scope, you can observe low-amplitude phenomena.*

**F**EW WOULD argue the fact that the oscilloscope is one of the most important tools of the service technician, the experimenter, and other workers in electronics. Nevertheless, a frequent shortcoming of this instrument is its lack of sensitivity.

True enough, expensive commercial instruments are available with a sensitivity rating on the order of 1 millivolt peak-to-peak per centimeter of deflection (equivalent to about .9 millivolt r.m.s. per inch of deflection). However, typical scopes owned by service technicians or experimenters—such as kit-assembled and other comparable units—may have sensitivity ranging from 25 to 90 millivolts r.m.s. per inch deflection.

This relatively low sensitivity does not permit an adequate display of such low-level signals as those generated by magnetic phonograph pickups, dynamic microphones, a.c. bridges near balance, and certain types

of receivers or certain portions of receiver circuits. It is worth noting at this point that, when we wish to observe low-level signals such as these, we are seldom concerned with precise measurements of amplitude, but more usually with the appearance or wave-shape of the observed phenomenon, and perhaps with relative indications of amplitude.

To increase sensitivity of an oscilloscope, we can obviously attempt modification of the vertical amplifier. However, this is a tricky business with many other variables, including band-pass, which may be affected. It is simpler to leave the scope unchanged and to add an external preamplifier. With transistors now available for such an outboard accessory, a preamp that uses very little power and takes up a small amount of space becomes practical. Such a one was built by the author.

The unit to be described can be

housed in an aluminum box measuring a mere 2¼" x 2¼" x 4", as shown in Figs. 1 and 2. The preamp has 2 banana plugs (¼" apart) as output terminals. These make it possible to plug the preamp directly into the input terminals of most oscilloscopes. A set of standard universal binding posts at the input and one power-supply lead with a banana plug complete the external connections of the box. The ground terminals of preamp and oscilloscope serve as a power supply return lead. The preamplifier was designed to operate from a standard 22.5-volt battery. For greater convenience, however (with some resulting degradation of noise level), a power supply was built into the oscilloscope with which the preamp was to be used. The output of this power supply is connected to a jack on the front panel of the scope into which is plugged the power-supply lead of the preamplifier. Details of this power supply will be given later.

## Circuit Description

The preamplifier consists of three grounded-emitter transistor stages, with unbypassed emitter resistors connected between emitter and ground, as shown in Fig. 4. Unbypassed emitter resistors are desirable for a number of reasons:

1. They cause negative current feedback which tends to stabilize the operation of the transistors. Variations in collector current due to changes in ambient temperature are minimized by supplying a base bias current which varies in accordance with the value of collector current and in the proper direction to reduce the collector-current variations.

2. The negative feedback makes the characteristics of the stage less de-

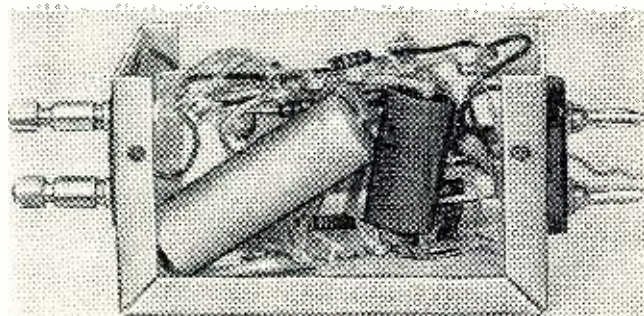

Fig. 2. Another view of the preamplifier shows the side that is not visible in Fig. 1.



pendent on transistor parameters.

3. Negative feedback widens frequency response and reduces distortion.

4. Finally, negative feedback increases the input impedance.

These desirable features are bought at the cost of gain, of course. When the emitter resistors are shunted by suitable capacitors, amplification increases, but most of the other advantages of negative current feedback are lost, *except for the stabilized operation of the transistors*. Thus the design of transistor amplifiers is the result of compromises.

The first stage of the preamplifier uses a Raytheon CK722 *p-n-p* transistor, while the other two use Raytheon CK721 *p-n-p* transistors. There is a direct-coupled, positive-feedback path between the emitters of the second and third stages which eliminates the necessity for bulky bypass capacitors across the emitter resistors. This feature, previously used in vacuum-tube circuits, is described in reference 3.

Two of the stages appear to have no bias current supplied to them, since there seems to be no direct current path to the base. Actually there is an internal resistance between collector and base—the collector resistance or leakage resistance—and some direct current passes through it to supply base bias.

It is always desirable to have a fairly high input impedance in preamplifiers such as this. Transistor circuits are inherently of low input impedance and, while a transistor circuit equivalent of a cathode follower does exist (see reference 5), its input impedance (on the order of 100,000 ohms) depends on the load impedance into which it works. This load impedance, the input impedance of the second stage, is about 1000 ohms. This would drop the input impedance of an emitter-follower circuit considerably. In addition, the gain of such a stage is less than one. It was instead decided to use a low-gain, grounded-emitter stage with a low value of collector load resistor and an unbypassed emitter resistor. The resultant negative-current feedback would provide the advantages already noted in addition to raising the input impedance.

A negative-feedback path between collector and base of the second stage serves to decrease the stage gain at

the low-frequency end of the spectrum, thus tending to widen the frequency response of the entire amplifier. Finally, a 100,000-ohm resistor across the output, while reducing the over-all gain somewhat, sets the gain value to 25 and makes this gain less dependent on the input impedance of the oscilloscope which the preamp feeds. Incidentally, this preamplifier would also be suitable for use with a.c. vacuum-tube voltmeters.

### Characteristics

Performance capabilities of the accessory are demonstrated by measurements taken on the completed unit. The results of such measurements were as follows:

**Gain:** 25 @ 1000 cps; -3 db @ 30 cps;  $\pm 1$  db from 50 cps to 20 kc.; -3 db at 50 kc.; -6 db at 100 kc. While the response of the accessory does not keep step with wideband oscilloscopes, it is sufficient to open up an entire new area of scope use with low-level phenomena. In this connection, it is interesting to note the large number of oscilloscopes being used successfully today by technicians and experimenters that provide bandpass no greater than that available from the preamp.

**Maximum input @ 1000 cps** before clipping is 165 millivolts r.m.s. This does more than overlap the range in which the oscilloscope itself becomes directly usable without the preamplifier.

**Input impedance** varies from 80,000 ohms @ 40 cps to 12,000 ohms @ 100 kc. More specifically, variation of this value is as follows: 80,000 ohms @ 40 cps; 47,000 ohms @ 1000 cps; 40,000 ohms @ 10 kc.; 22,000 ohms @ 40 kc.; and 12,000 ohms @ 100 kc.

**Noise level**, referred to the input (and using the oscilloscope power supply to be described later): with the input shorted, about 200 microvolts r.m.s.; with the input open, about 240 microvolts r.m.s.

**Power-supply requirements:** about .9 milliampere @ from -20 to -22.5 volts d.c.

### Construction Features

The entire preamplifier is contained in a 2¼" x 2¼" x 4" aluminum box. The circuit is built on a piece of ¼" Plexiglas sheet about 2" x 4½", which fits in the box diagonally. The circuit components are soldered to two sets

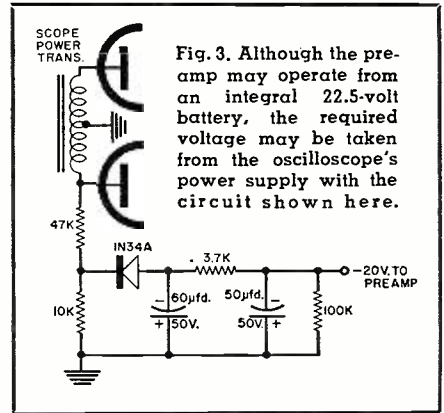

Fig. 3. Although the pre-amp may operate from an integral 22.5-volt battery, the required voltage may be taken from the oscilloscope's power supply with the circuit shown here.

of Bakelite tie points mounted on the Plexiglas. While the input consists of a standard terminal strip with double binding posts at ¼" spacing, the output is obtained from two all-metal banana plugs mounted on the same type of insulator used for the input terminals. This makes it possible to plug the preamplifier, by means of its banana-plug output terminals, directly into the scope input terminals (which have the standard ¼" spacing).

### Power Supply

While the preamplifier was designed to work with a 22.5-volt battery, for greater convenience a power supply (Fig. 3) was built into the scope with which the preamp was to be used. A voltage divider from one side of the scope power transformer to ground supplies about 50 volts r.m.s. to the cathode of a half-wave rectifier (1N34A germanium diode). A direct voltage, negative with respect to ground, develops across a large electrolytic capacitor connected to the "plate" of the rectifier. An additional RC filter removes much of the ripple. This ripple is responsible for most of the noise level measured. If a lower noise level is required, a more elaborate power supply will be required, unless a battery is used.

### REFERENCES

1. Lo, Endres, et al.: "Transistor Electronics," Prentice Hall, 1955.
2. "Transistor Applications," Raytheon Mfg. Co., Vol. 2, 1957.
3. Alexander, Frank C., Jr.: "Transistors Use Emitter-Coupled Feedback," Electronics, December 1954.
4. Shea, Richard F.: "Transistor Audio Amplifiers," John Wiley and Son, 1955.
5. Hellmers, A. H.: "Transistor Cathode Follower," RADIO & TV NEWS, October 1953.

-30-

Fig. 4. This 3-stage transistor amplifier feeds the scope input, may be operated from a battery or the supply in Fig. 3.

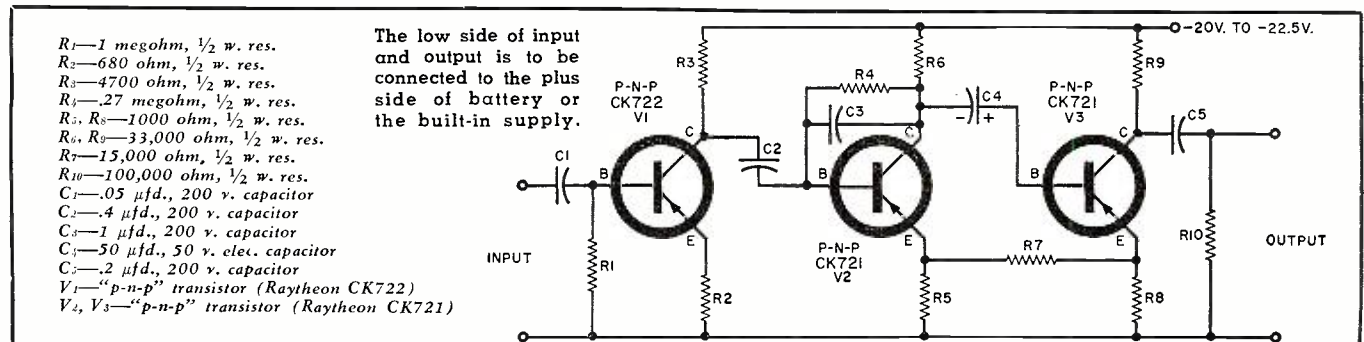



# FM

# Tuner Kit Features Novel "Front End"

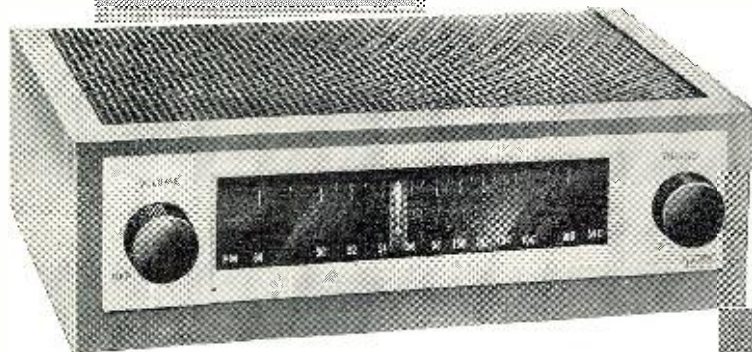

The sliding dial pointer, shown above, is in reality a most effective tuning indicator. Top chassis view is shown at right.

*Unusual imported front end is key to design. It simplifies over-all kit construction and the final alignment.*

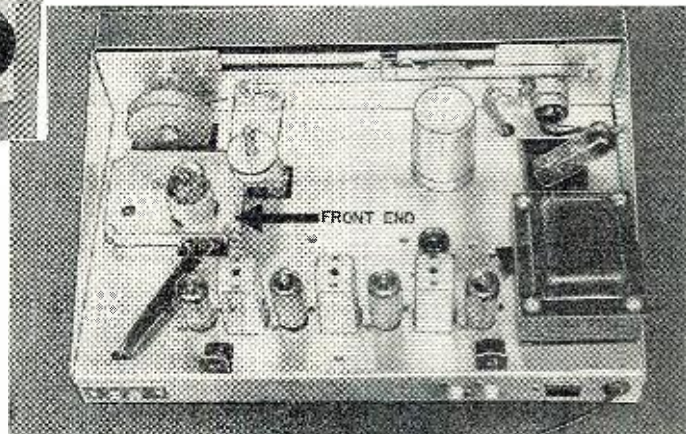

THE build-it-yourself craze that has swept the country in recent years has not neglected the electronic industry in general nor the high-fidelity field in particular. Power amplifiers, preamplifiers, crossover networks, speaker enclosures, and other items that could be added to the list have all been built by the "do-it-yourself" fan with astonishing success.

It wasn't too long ago that projects of this type were only attempted by those individuals familiar with electronics. Today, however, anyone who has acquired the knack of doing a good soldering job and will take the time to follow precise construction outlines can enjoy his modest triumph.

The FM tuner, on the other hand, has been one item that has presented almost insuperable difficulties to the home builder. There are several reasons for this: unusually compact construction; the need to work with r.f.

circuits which require short leads and more accurate routing of the wiring; and last, but not least, the final alignment procedures required. These problems, one by one, are being solved by the manufacturers. Lead lengths and dressing are more accurately covered in the construction pamphlets while the alignment procedures are being simplified by the use of pre-aligned components.

We don't necessarily agree that this is the final solution to the problem. We believe that all FM tuners should be aligned with suitable instruments. A simplified instrument alignment using an AM signal generator and v.t.v.m. is certainly not difficult. For those who do not have such equipment, it is frequently a simple matter to have the local service technician do the necessary alignment for a moderate fee.

One of the newest additions to the

limited number of well-engineered tuner kits is the *EICO* HFT-90. It is equal in design and performance to any tuner kit on the market today. It has two unusual features: a very novel front-end prewired assembly, and a moving tuning-eye indicator that is used in lieu of a conventional sliding dial pointer.

The front end is an inductively tuned assembly, housed and completely shielded in a solid aluminum zinc casting. This permeability tuned unit is imported. It is supplied with the kit in completely wired and aligned form. The alignment is such that the manufacturer has made a special point of mentioning that this unit should not be tampered with in any way. This front end not only provides high sensitivity and low noise but is extremely stable and guaranteed to be practically drift-free. The drift figure that was obtained on the kit that was built in our laboratory and then tested, measured only 18 kc. from a cold start to operating temperatures. This is approximately 1 part in 6000. As a result of this stability, a.f.c. (automatic-frequency control) has been found to be unnecessary. It is interesting to note that this same tuning unit is the one being used by *Motorola* and *Admiral* in their FM receivers.

The traveling tuning eye is one which previously was incorporated only in factory assembled high-fidelity units. It is making its first appearance in a kit in this tuner. This tuning eye, known as the DM-70, travels along the slide-rule dial as a luminous exclamation-point indicator. The lighted portion contracts like a conventional tuning eye when a station is tuned in. It is an accurate means of tuning.

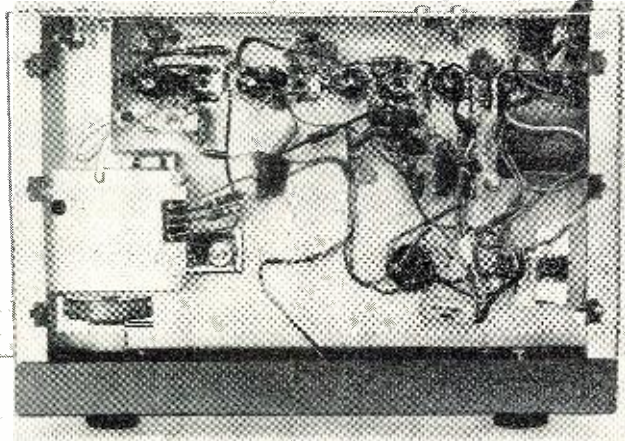

★  
Under-chassis view of FM tuner. Although no printed circuitry is used, the design is such that it is not over-crowded and wiring is not a major assembly problem.  
★







# Your Business Telephone

By  
WILLIAM LEONARD



*The success or failure of your service business  
may depend on the proper use of this instrument.*

**A**BOUT thirty years ago, Doctor Russel Conwell wrote a book, titled "Acres of Diamonds," that was a best seller in its day. The story dealt with a man who, after years of wandering around the world searching for the biggest diamond deposits, returned to his home in his old age. He then learned that the largest deposit of diamonds in the world had been discovered on the land he had left as a young man.

This is not the only story that has ever been told to illustrate the fallacy behind the "grass-is-always-greener-elsewhere" principle. Most important, while a man is engaged in fancying the greater possibilities that he imagines to exist in other places, he will tend to overlook the very tangible possibilities that may abound all around him.

The proverbial truth presented so effectively in this story applies to many things the average service dealer overlooks in the management of his business. The effective use of many of the facilities available to him and for which he is paying in the normal course of his business, would help to

resolve some of his most serious problems in the management of his business.

Take, for instance, the telephone. How many service dealers make maximum use of it in their businesses? How many dealers have given any serious thought to *how* they can use their telephones more effectively? A simple telephone check of dealers in any city would reveal that the percentage is quite small.

In practically all TV service businesses, the telephone is the first line of communication with old and new customers. Just how the phone is answered can make or break a business. *What* is said and *how* it is said means much to every customer. Carefully planned and consistently used good telephone techniques are vitally important in maintaining good customer relations.

Since the telephone is the initial point of contact with most customers, a dealer should give careful attention to the manner in which calls are handled in his business. A service business can be built on "a voice with a smile." Anyone can cultivate a friend-

ly, pleasant telephone personality. The dealer should train himself, and all those who handle customer phone calls in his shop, to make studied use of this technique.

Some dealers claim they have the most unreasonable and cantankerous customers in the business. If those dealers would set up recorders at their telephones and get a record of their responses to customer calls for service, they would discover how much their customers are influenced by the dealers' own attitudes.

Service is a "trouble" business. People hate to have to buy it. There is no thrill or pleasure about it like they get from buying a new product. The money they have to spend for service usually was earmarked to buy something else. Naturally, they are not happy about it.

A dealer who wants to build a good, stable service business must recognize the fact that a pleasant atmosphere and congenial attitudes must be constantly maintained in the midst of a turbulent sea of troubled customers. The first step in creating a *system* of good customer relations is to work up a carefully planned pattern for handling telephone calls. The next step is to see that it is followed regularly.

The points that must be considered in developing a phone-answering pattern should include: how the shop is to be identified in answering the phone; all of the information needed that will be most helpful in taking care of the service call; promises that are made to the customer; and how the customer is handled during the conversation.

Service customers are inclined to be impatient. This impatience will increase if the phone rings several times before it is answered. Consequently, service shop telephones should be answered promptly. It is the mark of an efficient business.

The person answering the phone should speak immediately so that the customer knows he or she is the center of attention. The shop should be identified by name. The person handling the call should speak directly into the mouthpiece, in a clear, distinct voice.

A pad of service-order forms should be handy at the phone at all times. The first thing to ask for in taking a service call is the customer's name. To eliminate confusion and possible misunderstanding, the name should be spelled out orally as it is written down so the customer can correct any mistakes in the spelling. From then on, the customer should be frequently addressed by name throughout the telephone conversation.

In every case, get as much information as possible about the trouble. Tell the customer what will be done and tell her when it will be done. When it is necessary to hold a customer on the line while information is obtained from someone else, extreme care should be taken to prevent any personal or side talk from being overheard. Another important point to remember is that

*(Continued on page 103)*



# Compac 35-Watt Standby Transmitter

By HAL BUMBAUGH, W6HI

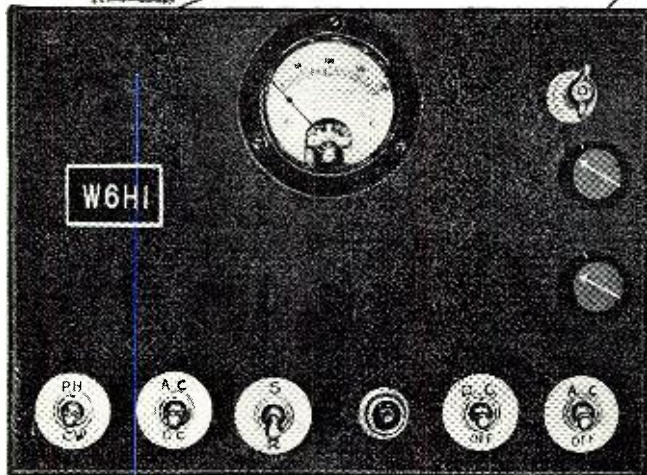

Fig. 1. Front-panel view of transmitter.

*Versatile little rig can operate from a variety of power sources and will load up any antenna.*

THE desire to have a standby rig at the shack and for mobile use enroute to camping or fishing grounds as well as for portable use for contact with the home base while there led to the development of this rig.

To be really valuable under the conditions mentioned a rig must not only have adequate power to insure communication by either code or phone but it must be capable of being powered in a variety of ways such as by a vibrator or rotary-generator type supply while in motion and 117-volt a.c., batteries, or again by a vibrator or rotary-generator type supply while in camp. In addition, it must be capable of using any length antenna which can be strung up or is available.

This little rig can be powered in almost any manner and adapted to the type of power available merely by flipping the appropriate switch on the front panel. Not only that but the change from phone to c.w., or *vice versa*, can be made by plugging either a mike or a key into the one jack. As a matter of fact the change from phone to c.w. may be made by flipping a switch on the front panel to change to c.w.—and sending c.w. with the button on the handle of the mike!

Conservative ratings are 25 watts on phone and 35 watts on c.w. with outstanding quality on phone and perfect keying on c.w.

The entire transmitter with its 117-volt a.c. power supply is housed in a 9 inch by 9½ inch case which is 7 inches high. The case shown in the photographs is that of an old SW-3. This will no doubt cause a flood of nostalgic memories for many an Old Timer since, in its day, the SW-3 was one of the really great ham receivers. If the junk box doesn't provide an old SW-3 case, any case of the same or greater dimensions can be used. While placement of parts is not critical, a couple of extra inches in all dimensions will provide greater ease in assembly.

## Circuit

Fig. 2 is the diagram of the complete transmitter. The oscillator is a Pierce circuit which is practically fool-proof insofar as sure starting, low crystal current, and good keying are concerned. Furthermore there are no tuning or circuit adjustments to be made. As a matter of fact, the only tuning controls for the entire transmitter are the loading and resonance capacitors associated with the pi-network within the case.

While at first glance the wiring, as shown in Fig. 2, might appear somewhat complicated such is really not the case as may be seen from the photograph of Fig. 4, which is the bottom view of the chassis.

Ordinary toggle switches are used throughout and, with the exception of the mike and modulator transformers used by the author, all required parts will be found in the average junk box.

The mike is a "converted" T17B. The conversion consisted of removing the original carbon transmitter and substituting an F1 unit for it. This F1 unit has no equal as a carbon button unit, both for quality and level—the output being practically zero level. It is available on the surplus market or from *Graybar Electric* (or *sub rosa*, from some friendly telephone man).

Such a microphone is invaluable for use with the extremely simple modulator unit shown. With the converted mike and the two 6V6 tubes in the modulator, it is possible to modulate an input of 25 watts 100% with ordinary "across the mike" close talking. Optimum results will be obtained when using the UTC S-19 modulation transformer by connecting as shown on the diagram. This connection gives a primary impedance of 8000 ohms and a secondary impedance of 3700 ohms.

The set-up for c.w. is also simplicity itself. As will be seen from the diagram the circuit for the cathode returns from both the 6V6 crystal stage and the 6L6 in the final is completed from the jack into which the microphone or key plugs. This is the keying lead and can be connected to ground through either the key or the button on the mike handle.

When on a.c., the current for the



Fig. 2. Here is the complete schematic diagram and parts listing for the rig. The voltages given directly below were obtained with typical rotary-generator.

NOTES: VOLTAGES  
 OPEN CIRCUIT 460V.(C.W.)  
 CLOSED 400V.(C.W.)  
 OPEN 360V.(PHONE)  
 CLOSED 320V.(PHONE)

ON T2 CONNECT TERMINAL 3 TO 4,  
 9 TO 10

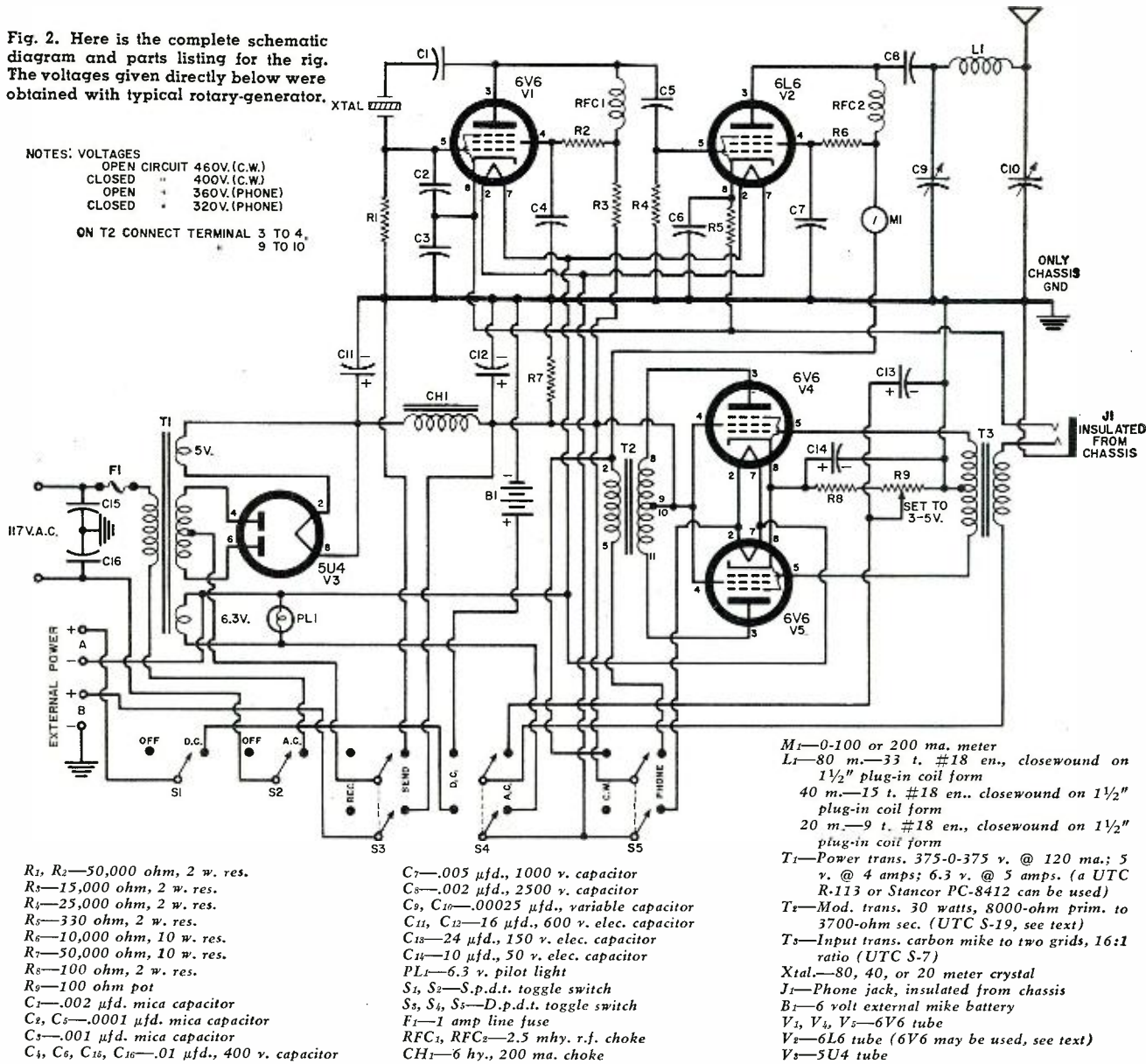

- R<sub>1</sub>, R<sub>2</sub>—50,000 ohm, 2 w. res.
- R<sub>3</sub>—15,000 ohm, 2 w. res.
- R<sub>4</sub>—25,000 ohm, 2 w. res.
- R<sub>5</sub>—330 ohm, 2 w. res.
- R<sub>6</sub>—10,000 ohm, 10 w. res.
- R<sub>7</sub>—50,000 ohm, 10 w. res.
- R<sub>8</sub>—100 ohm, 2 w. res.
- R<sub>9</sub>—100 ohm pot
- C<sub>1</sub>—.002 μfd. mica capacitor
- C<sub>2</sub>, C<sub>5</sub>—.0001 μfd. mica capacitor
- C<sub>3</sub>—.001 μfd. mica capacitor
- C<sub>4</sub>, C<sub>6</sub>, C<sub>15</sub>, C<sub>16</sub>—.01 μfd., 400 v. capacitor
- C<sub>7</sub>—.005 μfd., 1000 v. capacitor
- C<sub>8</sub>—.002 μfd., 2500 v. capacitor
- C<sub>9</sub>, C<sub>10</sub>—.00025 μfd., variable capacitor
- C<sub>11</sub>, C<sub>12</sub>—16 μfd., 600 v. elec. capacitor
- C<sub>13</sub>—24 μfd., 150 v. elec. capacitor
- C<sub>14</sub>—10 μfd., 50 v. elec. capacitor
- PL1—6.3 v. pilot light
- S<sub>1</sub>, S<sub>2</sub>—S.p.d.t. toggle switch
- S<sub>3</sub>, S<sub>4</sub>, S<sub>5</sub>—D.p.d.t. toggle switch
- F<sub>1</sub>—1 amp line fuse
- RFC<sub>1</sub>, RFC<sub>2</sub>—2.5 mhy. r.f. choke
- CH1—6 hy., 200 ma. choke

- M<sub>1</sub>—0-100 or 200 ma. meter
- L<sub>1</sub>—80 m.—33 t. #18 en., closewound on 1½" plug-in coil form
- 40 m.—15 t. #18 en., closewound on 1½" plug-in coil form
- 20 m.—9 t. #18 en., closewound on 1½" plug-in coil form
- T<sub>1</sub>—Power trans. 375-0-375 v. @ 120 ma.; 5 v. @ 4 amps; 6.3 v. @ 5 amps. (a UTC R-113 or Stancor PC-8412 can be used)
- T<sub>2</sub>—Mod. trans. 30 watts, 8000-ohm prim. to 3700-ohm sec. (UTC S-19, see text)
- T<sub>3</sub>—Input trans. carbon mike to two grids, 16:1 ratio (UTC S-7)
- Xtal.—80, 40, or 20 meter crystal
- J<sub>1</sub>—Phone jack, insulated from chassis
- B<sub>1</sub>—6 volt external mike battery
- V<sub>1</sub>, V<sub>2</sub>, V<sub>5</sub>—6V6 tube
- V<sub>3</sub>—5U4 tube

microphone is supplied by the resistor network shown between the cathodes of the 6V6 modulator tubes and ground. This arrangement furnishes completely hum-free current for the mike.

When on d.c., from 3 to 6 volts of battery are connected to the "External Mike Supply" binding posts on the rear of the case. Other posts are provided for connecting d.c. filament and plate power. When a rotary-generator supply is used, the 6-volt battery circuit can be connected directly to the "External Mike Supply" posts.

When set for c.w. operation, no power is supplied the modulator filaments—whether on d.c. or a.c.—and the modulation transformer secondary is automatically taken out of the circuit so that every possible bit of power is available for the c.w. operation.

Although a "garden variety" 6L6 is used in the rig shown, *General Electric* makes such a tube tested especially for r.f. use (they state the ordinary 6L6 is tested for audio service only)

and such a tube might possibly give better service. This special tube is designated as a 1614.

As will be seen from Fig. 2 both the screen and the plate of the 6L6 in the final are modulated—the screen through the 10,000-ohm, 10-watt resistor shown. In this connection it might be well to mention that a 6V6 will serve equally well in the final stage but with slightly reduced output. Should a 6V6 be used in the final only one 6V6 need be carried as a spare for the entire transmitter.

The pi-network plug-in coils are wound according to the data given in the parts list.

### Tuning

Tuning of the pi-network is simplicity itself but for the benefit of those who may not have used such a "contraption" before the following suggestions are offered.

With the transmitter set for c.w. and the key or mike button closed, set the capacitor nearest the antenna

(loading capacitor) at about half or three quarters capacity, then rotate the tuning capacitor to get the usual resonant plate current dip, as shown on the meter. Re-adjust the loading capacitor for the desired increase or decrease in plate current and again rotate the tuning capacitor for maximum current dip. This process should be repeated until the desired value of plate current is obtained at resonance.

It will be observed that the magnitude of the plate current dip will decrease as the loading is increased so that at full loading (75 to 90 ma.) care must be taken in setting the tuning capacitor for resonance since the magnitude of the dip will be extremely small.

### Construction

A small sub-panel should be constructed to fit the case chosen and the sub-panel depth should be approximately 2 inches. Turndowns of 2 inches should be made at the sides and a turndown of ¼ inch, for reinforce-



ment only, made at the front edge. No turndown is made at the back. Clearance is thus provided at the front for the toggle switches which are shown in Fig. 4 and for the binding posts for external battery and mike power which are placed at the rear of the case.

Lock washers should be placed under every nut to insure that rough handling will not loosen any of the components.

The chassis carries no ground returns or filament circuits. All "B-" and speech returns are made to a very short piece of heavy bus bar which is insulated from the chassis with the exception of the one point indicated in Fig. 2.

This makes an extremely clean, stable rig without a trace of misbehavior of any kind and no neutralization is required.

At the rear of the cabinet is a ground post which is insulated from the cabinet but connected to the "B-" bus by a heavy piece of stranded wire.

Figs. 1, 3, and 4 show the front view, top view, and bottom view respectively.

In Fig. 1 the switches are, reading left to right: phone-c.w.; a.c.-d.c.; send-receive; d.c. (on-off); and a.c. (on-off).

At the right-hand top corner is the antenna post and below it the loading and tuning capacitors for the pi-network.

The jack for microphone or key is at the rear of the case.

In Fig. 3 the layout of the components is shown. Across the bottom (rear of case) is the a.c. power supply. The tube line-up above is right to left: the two modulator tubes; the oscillator tube, and the final tube. The crystal appears between the second modulator tube and the oscillator tube.

At the top right is the UTC S-19 modulation transformer, next the UTC S-7 microphone transformer and, between this transformer and the pi-network capacitors, is the plug-in pi-network inductance. All inductances are wound on 1½ inch 4-prong coil forms.

Fig. 4 shows the sub-panel wiring. It will be seen that the wiring is not crowded in spite of the number of control circuits and switches used.

The shortest possible leads are used—to which the layout lends itself well—and every effort was made to secure extreme mechanical rigidity.

When in use, a cover plate on the bottom of the case protects the sub-panel wiring. For long periods of operation the hinged top of the case is raised to assist in dissipating the heat generated by the tubes.

The rig can be operated with or without the chassis connected to ground but for local work a good ground connection has been measured as providing 8 db more output than with the transmitter ungrounded. This may be due largely to a redistribution of energy between the sky and the ground wave.

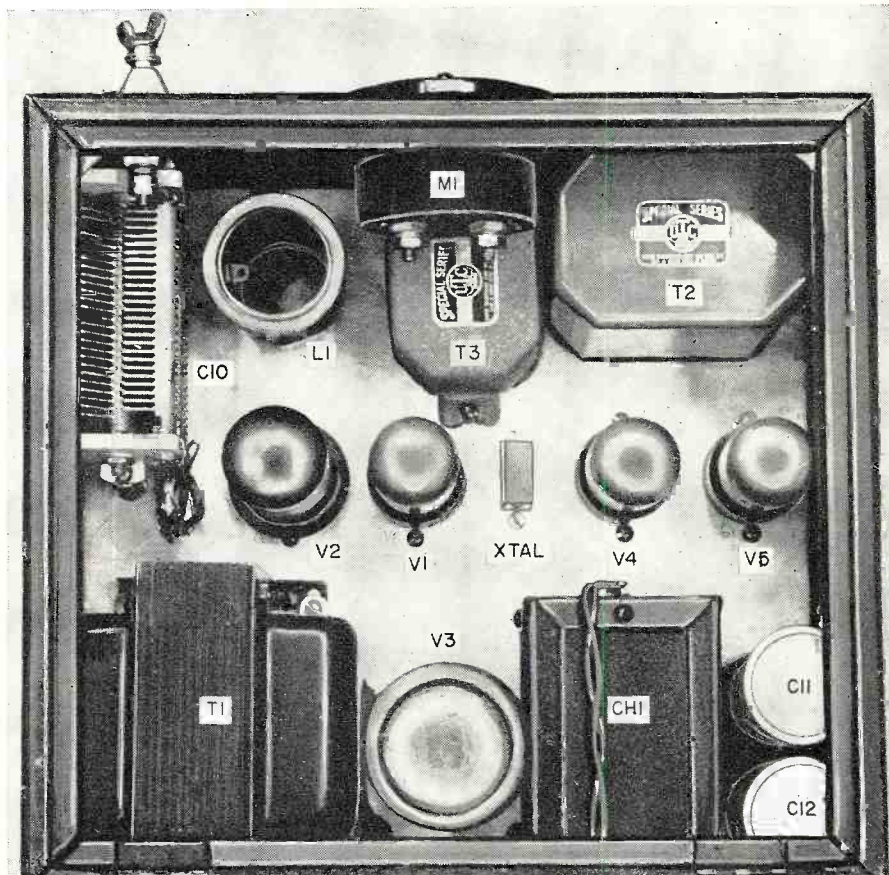
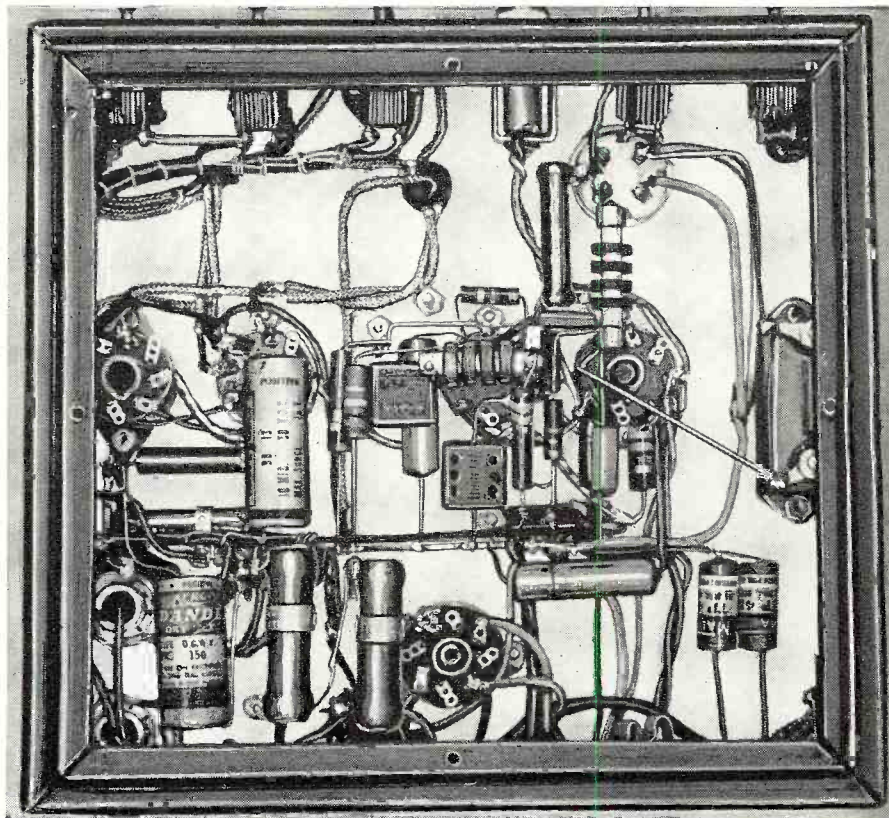

Fig. 3. Top view of transmitter with hinged cover opened up. Across the bottom (rear of case) is the a.c. power supply. The tube lineup above is (right to left): the two modulator tubes, the oscillator tube, and the final tube. The crystal appears between the second modulator tube (which is V<sub>1</sub>) and the oscillator (V<sub>1</sub>).

Fig. 4. Bottom view of the little rig. A cover plate, which provides shielding and protection for the wiring shown here, has been removed in order to show these components. Wiring is not crowded in spite of the number of control circuits and switches used. The shortest possible leads are used according to good practice.







By JOHN T. FRYE

## NEW USES

**B**ARNEY came through the door of the service department at his usual loping gait to find Mac bent over the bench, but the youth stopped short in his tracks as his employer straightened up and turned around.

"Hey, man, where did you get the eye-crutches?" Barney exclaimed. "I thought you were Mr. 20/20 himself."

"So did I," Mac admitted ruefully as he slid off the hornrimmed glasses and put them in a pocket case; "and the way I found out different is a joke on me too good to keep. The other day I was working with the scope when I suddenly noticed something was wrong with it. The sine-wave trace sort of opened out at the knees of the curve so that two very closely spaced traces could be seen at these points. They merged together on the down-sloping portions. I made a couple of quick checks and found out that a straight horizontal line, when properly focussed, became two closely-spaced parallel lines. This was not true of vertical lines. When I removed all signals from both amplifiers and cut their gain controls clear back, instead of the tiny, beautifully round little dot of which I had been so proud, I saw two dots, almost touching, one above the other.

"You know I simply can't bear to have anything, no matter how minor, wrong with my scope; so I immediately set out to discover what had happened. The first thing I did was to spend about a half hour working with the spot-shaping, focus, and intensity controls trying to find a combination of settings that would get rid of the annoying condition; but nothing I did would banish the two dots. Next I decided a small signal, such as hum produced by a heater-cathode short in one of the vertical amplifier tubes, must be reaching the vertical deflection plates; so I connected these plates directly together. This made absolutely no difference on my double-dot trace and it left me with only one nasty probability: in spite of the special metal shield

around the CR tube, a magnetic field must somehow be affecting the trace. For the life of me, though, I could not see how this could have developed all at once.

"Checking for magnetic deflection on an electrostatic tube is not too simple a job. I moved the scope to different locations to make sure the deflecting field was not being produced by something outside the scope; but since the condition persisted unchanged, no matter where the scope was placed, I concluded the field had to be produced by the instrument itself, probably by the power transformer. I have some sheets of special magnetic shielding material and I tried inserting these between the power transformer and the scope gun. I even wrapped a sheet of the material completely around the outside of the CR tube. Same difference; nothing helped.

"Then I tried holding a powerful little magnet near the neck of the CR tube so as to distort the a.c. magnetic field I felt sure was causing the trouble. By positioning the magnet various ways, I could move the elongated spot about on the face of the tube; but I could not change the position of the dots with respect to each other. This simply was not right. I knew from experience that I should be able to change the slope of the short line made up of the two dots by moving my magnet about.

"As I was pondering this mystery, I noticed something else odd: when I backed away from the face of the scope some two feet or so, the dots seemed to move together. Curious about this, I got my jeweler's loupe and looked closely at the dots—or rather at the dot, for with the loupe only one dot was to be seen! That was all the clue I needed. I drew a straight line on a piece of paper and held it close to my face. When it was horizontal, I saw two lines; when it was vertical, I saw only one. I realized I had spent several hours in a vain attempt to locate a scope defect that

was all 'in the eye of the beholder!' "First thing the next morning I went to an oculist. He said the condition was not at all unusual for a person 'your age'—I hate that phrase!—and that I needed glasses for reading and close work. He must be right, too, for they certainly help in working with these darned little printed circuit transistor receivers or in trying to spot a broken wire in a coil."

"Well cut off my beam current!" Barney exclaimed with a grin. "I know you use that precious scope for doing just about everything around the shop, but I never thought you'd use it to test your eyes. Put on those cheaters again and let me look at you. H-m-m-m, I believe they make you look smarter and more dignified. I think I'll have to call you 'Mr. McGregor' when you've got them on." "You do and I'll wring your Irish neck," Mac promised.

"That reminds me I've been wanting to show you some new uses I found for this gadget," Barney said as he took from his pocket a little flat, black, rectangular object with a wire coming out one end of it.

"What's that?"

"It's a telephone pickup. You place this under a telephone and connect this shielded wire to the microphone input of a tape recorder. Voice currents going both ways through the 'induction coil' of the telephone induce currents in the turns of this device that feed the recorder amplifier. This pickup is very sensitive to any sort of magnetic field."

"Quit talking as though I were a not-quite-bright child," Mac growled. "I know how a telephone pickup works."

"OK, OK! but let me show you some uses for it you don't know," Barney said as he connected the leads of the shielded cord to the vertical input connections of the scope. He turned up the signal generator feeding a little a.c.-d.c. receiver Mac had been testing on the bench and laid the pickup on top of the cabinet. The 400-cycle modulating wave appeared on the scope screen. The smallest variation in the signal delivered to the speaker was instantly apparent as a change in the size of the scope trace.

"You know it's almost impossible to get at the speaker voice-coil connections on lots of sets, especially transistor receivers," Barney explained. "With this arrangement serving as an output meter, you don't need to. Whenever the pickup is brought within several inches of the output transformer, any signal passing through the transformer is picked up and transferred to the scope. What's more, by examining the shape of the sine wave as well as its size, you can check the receiver for distortion at the same time you're going through the alignment."

"That would speed things up in many cases," Mac said thoughtfully.

(Continued on page 124)



You can do more than ever before with this new portable **B&K**

# AUTOMATIC MONEY-MAKER

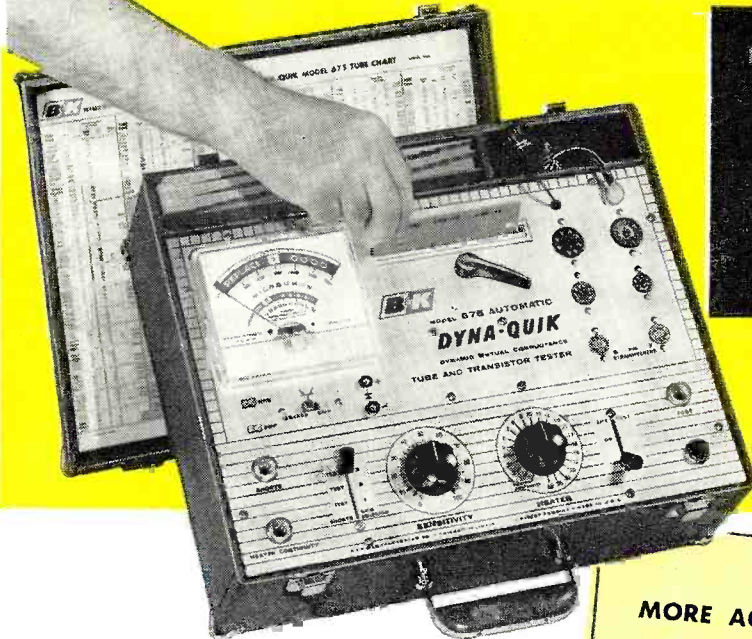

**TESTS TUBES  
AND TRANSISTORS  
Automatically**  
WITH LABORATORY ACCURACY

- Saves Servicing Time
- Sells More Tubes
- Satisfies More Customers



**B&K** MODEL 675  
AUTOMATIC  
**DYNA-QUIK**  
DYNAMIC MUTUAL CONDUCTANCE  
TUBE & TRANSISTOR TESTER

**MORE ACCURATE TEST**  
Tests Each Section of Multiple Tubes Separately for Gm, Shorts, Grid Emission and Life  
Tests each tube for Gas Content and Grid Emission simultaneously with Short check. Instantaneous Heater Continuity test.

**SIMPLIFIED AUTOMATIC DYNA-CARD SYSTEM**  
With only 60 heavy-duty, phenolic Dyna-Cards you can test over 500 tube types. Dyna-Card automatically sets socket connections for quick, accurate test. Each Dyna-Card is identified and indexed, ready to use. Always kept up-to-date simply by adding new Dyna-Cards. Minimizes obsolescence.

**CHECKS OVER 99%** of the tubes most widely used in television receivers plus popular home and portable radio tubes.

**ONE EXTRA TUBE SALE** on each of 5 calls a day pays for the Dyna-Quik in a few weeks.

**TESTS TRANSISTORS, TOO**  
Transistor Section checks junction, point contact and barrier transistors, germanium and silicon diodes, selenium and silicon rectifiers.

Again, B&K helps servicemen give faster, better service at less cost and make more money. The new automatic Model 675 makes tube checking quick and easy in the home or shop. (Tests transistors, too.) Measures true dynamic mutual conductance. Makes complete tube test in seconds, under actual operating conditions of the set. Checks average set in a few minutes. Simple to operate. No multiple switching. No roll chart. Shows customer the true condition and life expectancy of tubes in the set, sells more tubes on-the-spot, saves call-backs. Quickly pays for itself.

Shows tube condition on "Good-Bad" scale and in micromhos. Large 4½" meter has two highly accurate ranges calibrated 0-6000 and 0-18,000 micromhos. 7-pin and 9-pin straighteners are mounted on panel. Automatic line compensation. Special bridge monitors line voltage continuously. Light weight, easily portable in handsome leatherette-covered carrying case. Operates on 105-125 volts 60 cycle a.c. Size: 15¼" x 12¼" x 6". Net wt: 10½ lb. Net, **\$169<sup>95</sup>**

Also makers of famous CRT, DYNA-SCAN, CALIBRATOR



See your B&K Distributor, or write for Bulletin AP12-N

**B & K MANUFACTURING CO.**  
3726 N. Southport Ave. • Chicago 13, Illinois

Canada: Atlas Radio Corp., 50 Wingold, Toronto-10, Ont. Export: Empire Exporters, 438 Broadway, New York 13, N.Y.



# "HEATHKITS<sup>®</sup>

*gave me my start and I'm still sold!"*

"... they are my lowest cost way to real quality and dependability in electronic equipment of any kind ...

... The clean, modern styling of HEATHKITS make me proud to own them. They make a handsome and useful addition to my workshop.

... Rigid quality standards of components used in HEATHKITS assure me of performance equal to or surpassing instruments costing many times more.

... after assembling a HEATHKIT myself, I know what "makes it tick". . . I know that the thoughtful circuitry design and name-brand components used throughout guarantee me years of trouble-free service.

... HEATHKITS cost me half as much as ordinary equipment . . . and I get so much more. In assembling my own instruments I am sure of the quality that goes into them. Plus the complete assembly and operating instructions as well as detailed schematics that are at my fingertips for future reference."

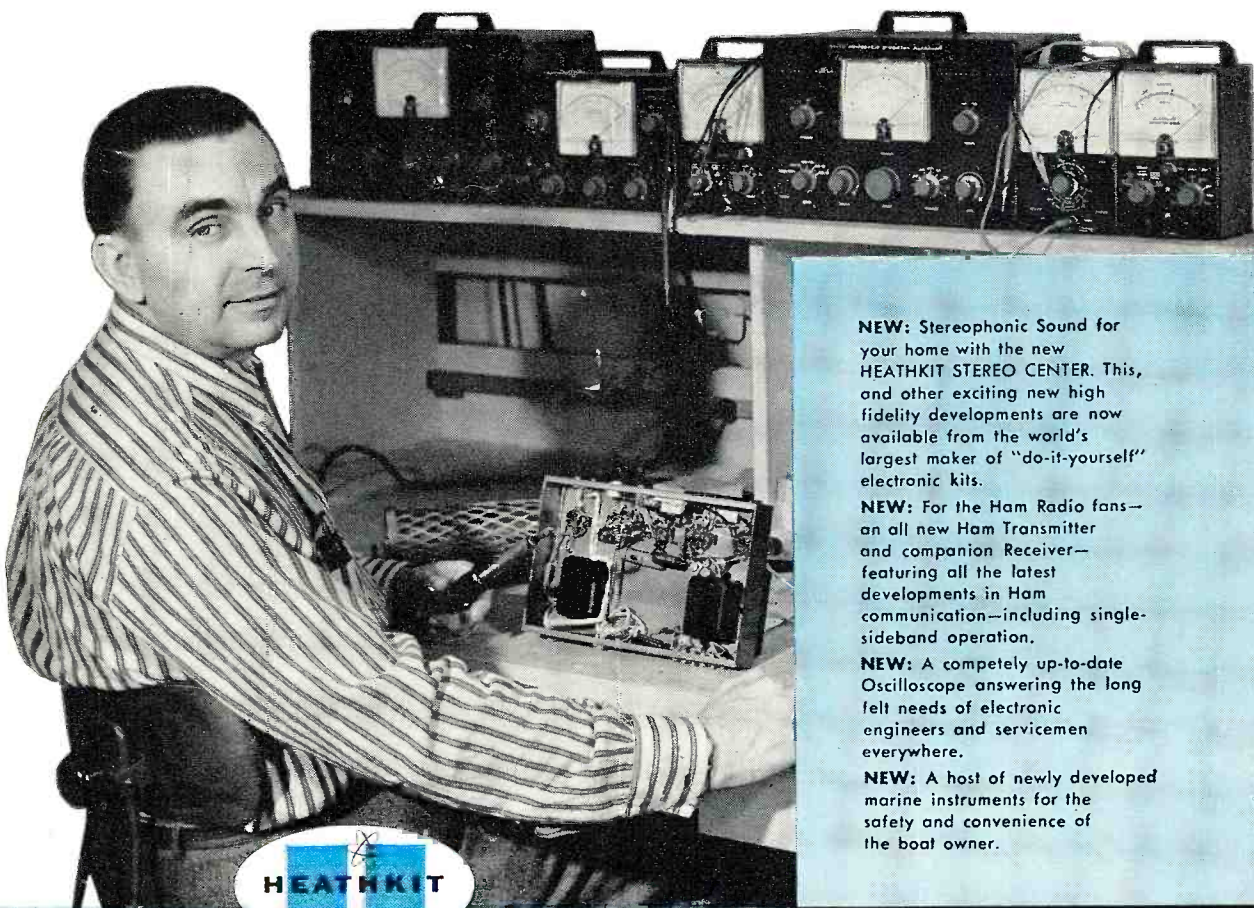

**NEW:** Stereophonic Sound for your home with the new HEATHKIT STEREO CENTER. This, and other exciting new high fidelity developments are now available from the world's largest maker of "do-it-yourself" electronic kits.

**NEW:** For the Ham Radio fans—an all new Ham Transmitter and companion Receiver—featuring all the latest developments in Ham communication—including single-sideband operation.

**NEW:** A completely up-to-date Oscilloscope answering the long felt needs of electronic engineers and servicemen everywhere.

**NEW:** A host of newly developed marine instruments for the safety and convenience of the boat owner.



**HEATH COMPANY** Benton Harbor 15, Michigan

 a subsidiary of Daystrom, Inc.

The HEATH TIME PAYMENT PLAN allows you to outfit your whole workshop at one time with needed test instruments while you pay in easy monthly installments.



### PROFESSIONAL OSCILLOSCOPE KIT

An exciting development in the Heathkit test instrument line is the introduction of the Heathkit model OP-1 Professional Oscilloscope. Emphasizing complete flexibility in any application, the OP-1 features DC coupled amplifiers and also DC coupled CRT tube un-blanking. The triggered sweep circuit will operate on either internal or external signals and may be either AC or DC coupled. The polarity of the triggering signal may also be selected, and any point on the wave form may be selected for the start of the sweep by using the "triggering level" control. An automatic position is also provided, in which the sweep recurs at a 50 cycle rate, but can be driven over a wide range of frequencies with no additional adjustments. The sweep frequencies are provided by switch-selected base rates of 2 and .2 milliseconds/CM, and 20, 2, and 1 microseconds/CM, in conjunction with a continuously variable 10 to 1 multiplier. Sweep frequencies are calibrated to within 10% at all control settings, and the sweep frequency may be reduced by adding capacity to the "ext. cap" binding post on the front panel. A 5ADP2 flat face CR tube is used for accurate readings on an edge lighted grid screen. A high quality conetic-fernetic CR tube shield prevents stray AC fields from distorting trace. A 12-position vertical attenuator is calibrated in volts-per-CM and the horizontal sweep is calibrated in time-per-CM. Prewired terminal boards are used for rapid, easy assembly of all critical circuits. Simply install and connect the color coded leads. Power supply is transformer operated utilizing silicon diode rectifiers and is fused for protection. Under development for over a year the OP-1 promises outstanding results in any application requiring the use of an oscilloscope.



HEATHKIT  
OP-1  
**\$179<sup>95</sup>**

**Here's the scope you've  
been waiting for!**

AVAILABLE AFTER JUNE 15

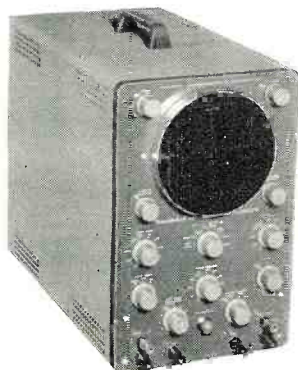

**Laboratory  
Performance At Less  
Than Utility Scope  
Price**

HEATHKIT  
O-12 **\$64<sup>95</sup>**



**A Scope You Will Be  
Proud To Own**

HEATHKIT  
OM-3 **\$39<sup>95</sup>**

#### "EXTRA DUTY" 5" OSCILLOSCOPE KIT

Top quality features at half the cost of ordinary equipment sum up the advantages of this popular kit. Critical observations in your laboratory or shop are handled easily, with clear, sharp pattern displays in every application. Vertical frequency response extends from 3 CPS to 5 mc  $\pm 1.5$  db — 5 db without extra switching. Response is down only 2.2 db at 3.58 mc. The Heath patented sweep circuit functions effectively from 10 CPS to better than 500 kc in five steps, giving you 5 times the usual sweep obtained in other scopes. An automatic sync circuit with self-limiting cathode follower provides excellent linearity and lock-in characteristics. Extremely short retrace time and efficient blanking action. Both vertical and horizontal output amplifiers are push-pull and the scope incorporates a 1 V peak-to-peak calibrating source, step attenuated and frequency compensated vertical input, plastic molded capacitors and top quality parts throughout. The 11-tube circuit features a 5UP1 cathode ray tube, and provision is made for Z-axis input for intensity modulation of the beam. Frequency response of the horizontal amplifier is within  $\pm 1$  db from 1 CPS to 200 kc. Horizontal sensitivity is 0.3 volts RMS per inch. Construction is simplified through the use of two metal circuit boards and precut, cable wiring harness. Shpg. Wt. 22 lbs.

#### GENERAL PURPOSE 5" OSCILLOSCOPE KIT

For servicing and routine laboratory work this fine kit is a favorite with technicians throughout the country. It incorporates many extras not expected at this low price. Features wide vertical amplifier frequency response, extended sweep generator operation, and improved stability. Frequency response of the vertical amplifier is within  $\pm 3$  db from 4 CPS to 1.2 mc. Vertical sensitivity is .09 volts RMS per inch at 1 kc. Sweep generator functions reliably from 20 CPS to over 150 kc. A modern etched circuit board is featured for high stability and reduces assembly time considerably. Standard components are mounted on this board with each position clearly marked preventing wiring errors. Both vertical and horizontal amplifiers are push-pull types. Uses a 5BP1 CRT. Provision for external or internal sweep or sync, built in 1 V peak-to-peak reference voltage and calibrated grid screen. An adjustable "spot shape" control is provided to insure a sharp trace. Input to the vertical amplifiers is through a step attenuated, frequency compensated circuit. The OM-3 is an extremely versatile instrument and has a multitude of practical uses in electronic testing fields. Particularly useful in alignment of television receivers, for testing audio amplifiers and circuits, and checking the quality of modulated RF signals in Ham Radio transmitters. Shpg. Wt. 22 lbs.



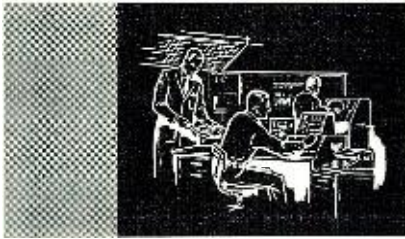

## Equip Your Service Bench

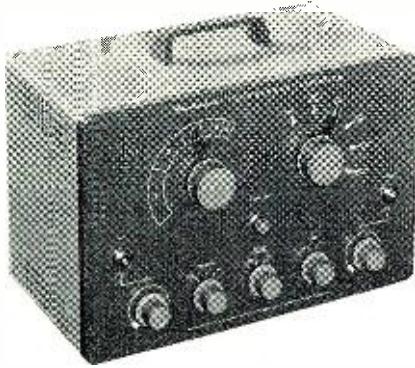

HEATHKIT  
CD-1 **\$59<sup>95</sup>**

### Cash In Now On Color TV

- ★ 10 VERTICAL COLOR BARS
- ★ CRYSTAL CONTROLLED ACCURACY
- ★ CHOICE OF 6 DIFFERENT PATTERNS

### COLOR BAR AND DOT GENERATOR KIT

Colored television is now a reality and as the number of these sets increase the need for a reliable service instrument is apparent. Nothing on the market... in this type of generator has as many features as the CD-1 at such a tremendous price saving. This unit combines two basic color service instruments, a color bar generator, and white dot generator in one versatile portable unit which has crystal controlled accuracy and stability for steady locked-in patterns (requires no external sync leads). Color receivers converged with the CD-1 will still be converged properly on a television program from the station. The 13-tube circuit has been carefully laid out for ease of assembly and provides choice of six different patterns. Produces white-dots, cross hatch, horizontal and vertical bars, ten vertical color bars, and a new shading bar pattern for screen and background adjustments. Variable RF output on any channel from 2 to 6. Positive or negative video output, variable from 0 to 10 volts peak-to-peak. Crystal controlled sound carrier with off-on switch. Voltage regulated power supply uses long-life silicon rectifiers. Kit includes three crystals and test lead, plus an information packed instruction manual covering convergence, and screen and background adjustments of a color TV set. Compare with other generators on the market and you will see that this instrument is loaded with extras and top quality all the way through. Shpg. Wt. 13 lbs.



HEATHKIT  
TS-4A **\$49<sup>50</sup>**

**For fast,  
easy alignment  
of TV sets**



HEATHKIT  
AG-10 **\$49<sup>95</sup>**

**Sine and  
square waves for  
countless uses**



HEATHKIT  
MM-1  
**\$29<sup>95</sup>**

**High accuracy  
in a  
portable meter**



HEATHKIT  
M-1  
**\$17<sup>95</sup>**

**An all-round  
meter of  
many uses**

#### TV ALIGNMENT GENERATOR KIT

This generator has many special design features for flexible, easy operation and reliability. The all-electronic sweep circuit insures stability and covers 3.6 mc to 220 mc in four bands. Sweep deviation is controllable from 0 to 42 mc. Crystal and variable marker oscillators are built in. Crystal (included with kit) provides output at 4.5 mc and multiples thereof. Variable marker provides output from 19 to 60 mc on fundamentals and from 57 to 180 mc on harmonics. Effective two-way blanking and phasing control also provided. A truly outstanding number of features at a tremendous price saving. Shpg. Wt. 16 lbs.

#### SINE-SQUARE GENERATOR KIT

High quality sine and square waves are produced by this generator over a wide range. Frequency response is 1.5 db from 20 CPS to 1 mc on both sine and square waves, with less than .25% sine wave distortion. 20 to 20,000 CPS. Output impedance is 600 ohms on sine wave and 50 ohms on square wave (except on 10 volt range). Square wave rise time less than .45 microseconds. Five-position bandswitch—continuously variable tuning—shielded oscillator circuit—separate step and variable output attenuators in ranges of 10, 1 and .1 volts with extra range of .01 volt on sine wave. Shpg. Wt. 12 lbs.

#### 20,000 OHMS/VOLT VOM KIT

This meter is ideal for use in field applications where accuracy is important. Employs a 50 ua 4 1/2 meter, and features 1% precision multiplier resistors for high accuracy. Requires no external power for operation (batteries supplied). Sensitivity is 20,000 ohms-per-volt DC and 5,000 ohms-per-volt AC. Measuring ranges are 0-1.5, 5, 50, 150, 500, 1500 and 5,000 volts AC and DC. Measures direct current in ranges of 0-150 ua, 15 ma, 150 ma, 500 ma and 15 a. Resistance multipliers are x 1, x 100 and x 10,000. Covers -10 db to +65 db. Batteries and test leads are also included with this kit. Shpg. Wt. 6 lbs.

#### HANDITESTER KIT

Small enough to carry with you wherever you go, this fine handitester is ideal for use in portable applications when making tests away from the work bench or as an "extra" meter in the service shop, when the main instruments are occupied. The combination function-range switch simplifies operation. Measures AC or DC voltage from 0-10, 50, 300, 1000 and 5000 volts. Direct current ranges are 0-10 ma and 0-100 ma. Ohmmeter ranges are 0-3000 and 0-300,000. Top quality precision components employed throughout. Very popular with home experimenters and electricians. Shpg. Wt. 3 lbs.



with Low-Cost Dependable Heathkits



### ETCHED CIRCUIT VTVM KIT

The fact that this instrument is outselling all other VTVM's says a great deal about its accuracy, reliability, and overall quality. The precision and quality of the components used in this VTVM cannot be duplicated at this price through any other source. Its attractive appearance as well as its performance will make you proud to own it. A large 4½" panel meter is used for indication, with clear, sharp calibrations for all ranges. Front panel controls consist of a rotary function switch and a rotary range selector switch, zero-adjust and ohms-adjust controls. Precision 1% resistors are used in the voltage divider circuit. An etched circuit board is employed for most of the circuitry, cutting assembly time and eliminating the possibility of wiring errors. It also assures duplication of laboratory instrument performance. This multi-function VTVM will measure AC voltage (RMS), AC voltage (peak-to-peak), DC voltage and resistance. There are 7 AC (RMS) and DC voltage ranges of 1.5, 5, 15, 50, 150, 500 and 1500. In addition there are 7 peak-to-peak AC ranges of 0-4, 14, 40, 140, 400, 1400 and 4,000. Seven ohmmeter ranges providing multiplying factors of x 1, x 10, x 100, x 1000, x 10 k, x 100 k and x 1 megohm. Center scale resistance readings are 10, 100, 1000, 10 k, 100 k ohms, 1 megohm and 10 megohms. A zero-center scale db range is also provided. Battery and test leads included with kit. Shpg. Wt. 7 lbs.

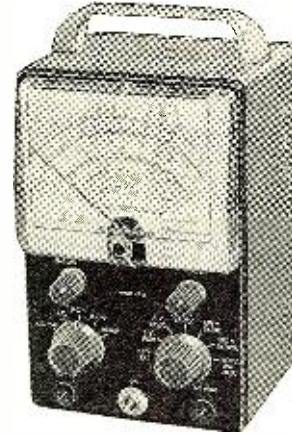

HEATHKIT  
V-7A  
\$24.50

World's largest selling  
VTVM kit

- ★ LARGE EASY-TO-READ 4½" 200 UA METER
- ★ 1% PRECISION RESISTORS EMPLOYED FOR HIGH ACCURACY

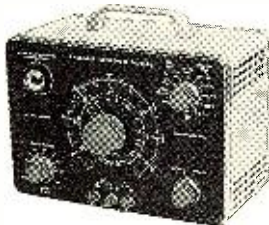

HEATHKIT  
C-3 \$19.50

Checks all types of  
condensers accurately

### CONDENSER CHECKER KIT

Check unknown condenser and resistor values quickly and accurately. Capacity measurements are made in four ranges of .00001 mfd-.005 mfd; .001 mfd-.5 mfd; .1 mfd-50 mfd; 20 mfd-1,000 mfd. Checks paper, mica, ceramic, and electrolytic condensers. Leakage test provides switch selection of five polarizing voltages, 25 volts to 450 volts DC to indicate condenser operating quality under actual load conditions. Electron beam "eye" tube indicates balance and leakage. A spring return test switch automatically discharges condenser under test and eliminates shock hazard to the operator. Measures resistance from 100 ohms to 3 megohms in two ranges. Shpg. Wt. 7 lbs.



HEATHKIT  
T-4 \$19.95

Locate faults quickly  
by tracing signals

### VISUAL-AURAL SIGNAL TRACER KIT

Here is a brand new signal tracer completely redesigned with compact dimensions and new circuit layout. Features built-in speaker and electron beam "eye" tube for signal indication and a unique noise locator circuit. Ideal for use in AM, FM and TV circuit investigation. RF and audio inputs are provided in one convenient probe with switch on probe to select either input. Useful for checking microphones, phono cartridges, record changers, tuners, etc. Makes a handy substitution speaker for servicing TV sets at the shop. Transformer operated for safety and high efficiency. Complete with test leads and informative construction manual. Shpg. Wt. 6 lbs.

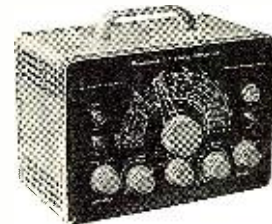

HEATHKIT  
SG-8 \$19.50

Easy-to-build—prewound  
and calibrated coils

### RF SIGNAL GENERATOR KIT

Save valuable time in aligning RF tuned circuits of all kinds with this easy-to-use kit. Also a quick way to trace signals in faulty RF, IF and audio circuits. Designed for general service applications—the SG-8 covers 160 kc to 110 mc on fundamentals in five bands, and from 110 mc to 220 mc on calibrated harmonics. The entire oscillator circuit is built on a special sub-chassis, using prewound and calibrated coils. No further calibration is required so it is ready to use as soon as construction is completed. RF output is in excess of 100,000 microvolts, controlled by both step and continuously variable controls. Complete with output cable and instructions. Shpg. Wt. 8 lbs.

HEATH COMPANY • a subsidiary of Daystrom, Inc. • Benton Harbor 15, Mich.



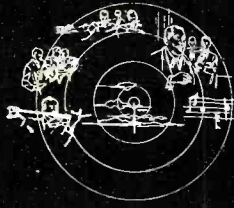

Enjoy Rich 3 Dimension Sound...

## Beautifully Styled with Plenty of Room for the Most Complete Stereo System

AVAILABLE IN THE FOLLOWING MODELS:

Model SE-1B—Stereo Equipment Cabinet (birch)

Model SE-1M—Stereo Equipment Cabinet (mahogany)

Model SC-1BR—Stereo Wing Speaker Enclosure (birch—right end)

Model SC-1BL—Stereo Wing Speaker Enclosure (birch—left end)

Model SC-1MR—Stereo Wing Speaker Enclosure (mahogany—right end)

Model SC-1ML—Stereo Wing Speaker Enclosure (mahogany—left end)

HEATHKIT  
**SE-1**  
PRICE TO BE  
ANNOUNCED

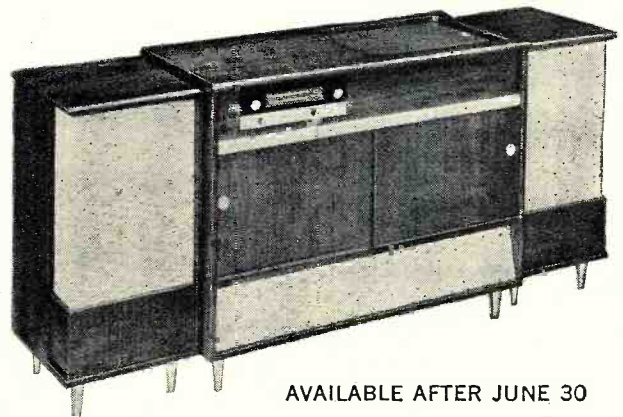

AVAILABLE AFTER JUNE 30

### STEREO EQUIPMENT CABINET KIT

Imagine!... Stereophonic sound in your own home. This superbly designed cabinet holds all of your hi-fi stereo equipment and lends striking elegance to your living room. The attractive gold and black panels, trim and hardware brilliantly highlight the overall effect. Rich toned grille cloth, flecked in gold and black, complement the cabinet. The unit has ample room provided for an AM-FM tuner, tape deck, stereo pre-amplifier, amplifiers, record changer, record storage and speakers. Beautifully grained ¾" solid core Philippine mahogany or select birch plywood is used for construction. The top features a shaped edge and sliding top panel for easy access to the stereo tape deck and stereo preamplifier. Sliding doors are employed for convenient front access to the

changer and record storage compartment. All parts of the cabinet are pre-cut and pre-drilled for simple assembly. The speaker wings and center cabinet may be purchased separately if desired. Note: the kit is delivered equipped with panels pre-cut to accommodate Heathkit components and also blank panels to cut out for your own equipment. Measurements of the individual component areas follow: tape deck and pre-amplifier area 20¾" L. x 17¾" W. x 10" D., record changer area 21" W. x 16" D. x 9⅝" H., record storage area 22⅝" W. x 14½" H. x 12½" D., speaker wing area (inside) 14" W. x 29½" H. x 15¾" D., AM-FM Tuner area 20½" W. x 5¼" H. x 14" D., amplifier (2 areas) 15¼" W. x 10¾" H. x 13¼" D.

Model HH-1B Birch  
Model HH-1M Mahogany  
Now only **\$299<sup>95</sup>** each

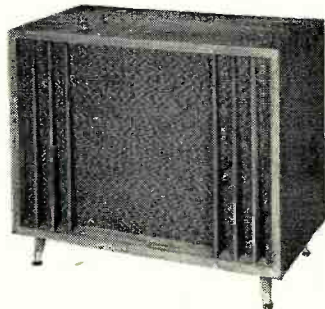

**The Same Superior Performance  
At a New Low Price**

HEATHKIT  
SS-2 **\$39<sup>95</sup>**



OPTIONAL LEGS  
EXTRA

**Economical Hi-Fi For Your Home**

### "LEGATO" HI-FI SPEAKER SYSTEM KIT

The increasing sales of the Legato has made more economical quantity production possible so we are passing the savings on to you by offering you this magnificent speaker system at a reduced price. Truly a "queen" among hi-fi speaker systems, the Legato was specially designed to meet and surpass the most stringent requirements of high fidelity sound reproduction. Two 15" Altec Lansing low frequency drivers cover frequencies of 25 to 500 CPS while a specially designed exponential horn with high frequency driver covers 500 to 20,000 CPS. A unique crossover network is built in making electronic crossovers unnecessary. Internal reflections are absorbed by splayed back panel and a 3" fiber glass lining. The Legato emphasizes simplicity of line and form to blend with modern or traditional furnishings. Cabinet construction is ¾" veneer surface plywood in either African mahogany or white birch and measures 41" L. x 22¼" D. x 34" H. All parts are pre-cut and pre-drilled for easy assembly. Shpg. Wt. 195 lbs.

### "BASIC RANGE" HI-FI SPEAKER SYSTEM KIT

True high fidelity performance at modest cost make this basic speaker system a spectacular buy for any hi-fi enthusiast. The amazing performance of this popular kit is made possible by the use of high quality speakers in an enclosure specially designed to receive them. The cabinet is a ducted port bass reflex type enclosure 11½" H. x 23" W. x 11¾" D. It features an 8" mid range woofer to cover 50 to 1600 CPS and a compression-type tweeter with flared horn covering 1600 to 12,000 CPS. Both speakers are by Jensen. The adjustable flared tweeter horn allows speaker to be used in either upright or horizontal position. The cabinet is constructed of ½" veneer surfaced plywood suitable for light or dark finish of your choice. All wood parts are pre-cut and pre-drilled for easy assembly. Shpg. Wt. 25 lbs.

Attractive brass tip accessory legs convert SS-2 into attractive console. Legs screw into brackets provided. All hardware included. Shpg. Wt. 3 lbs. No. 91-26 \$4.95



with a Heathkit Stereo System



**HIGH FIDELITY STEREO TAPE DECK KIT**

For your unparalleled enjoyment in the world of stereophonic sound Heathkit brings you an all new stereo tape deck. This tape deck is a precision engineered instrument providing monaural record/playback, and stereo playback of prerecorded tapes. Incorporates three separate heads, erase-record-stereo playback (stacked). The mechanical tape deck assembly is supplied complete. You build only the record and playback circuit employing two etched circuit boards for ease of wiring. Low noise EF-86 tubes in input stages and efficient push-pull bias-erase oscillator insures complete freedom from hum and noise in recording and playback. Provision made for 3/4 and 7 1/2 IPS tape speed selected by a push button. Deck handles up to 7" reels of tape. Other features are: provision for monitoring tape while recording, built in VU meter for proper recording level, pause control for editing tape, "fast forward" and "rewind" control. Frequency response at 7 1/2 IPS tape speed is  $\pm 2$  db from 40 to 12,000 CPS, at 3/4 IPS speed 40 to 6,000 CPS. Signal-to-noise ratio is 55 decibels with less than 1% total harmonic distortion. NARTB tape playback equalization. A safety interlock button prevents accidentally switching to record position causing erasure of recorded tapes. Shpg. Wt. 33 lbs.

Model TR-1C monaural tape deck incorporates all of the features described for the model TR-1D with the exception of stereo playback. \$131.95.

No. C-TR-1C conversion kit converts model TR-1C to include stereo function of model TR-1D. \$15.95.



HEATHKIT TR-1D \$143<sup>95</sup>

**Preassembled Tape Mechanism . . .  
You Build Only Electronic Circuit**

AVAILABLE AFTER JUNE 30

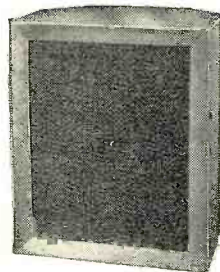

HEATHKIT SS-1B \$99<sup>95</sup>

**Fill out the Hi-Fi Range of Your SS-2 Speaker**

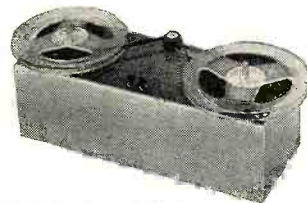

HEATHKIT SW-1 PRICE TO BE ANNOUNCED

**Save Time Rewinding Tape**

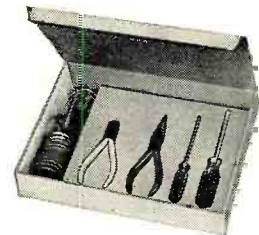

HEATHKIT TK-1 \$9<sup>95</sup>

**All The Tools You Need For Building Heathkits**

**"RANGE EXTENDING" HI-FI SPEAKER SYSTEM KIT**

This is not a complete speaker system in itself, but is designed to extend the range of the SS-2. The SS-1B uses a 15" woofer and a small super tweeter to supply the very high and very low frequencies to fill out the response of the basic SS-2. The SS-2 and SS-1B when used together, form an integrated four speaker system. The SS-2 and SS-1B combination provide an overall response of  $\pm 5$  db from 35 to 16,000 CPS. The kit includes circuit for crossover at 600, 1600 and 4,000 CPS. Impedance is 16 ohms and power rating is 35 watts. A control is also provided to limit output of super tweeter. The handsome cabinet measures 29" H. x 23" W. x 17 1/2" D. Constructed of beautiful 3/4" veneer surface plywood. Complete step-by-step instructions make this kit easy to build. No wood-working experience required. Shpg. Wt. 80 lbs.

**"SPEEDWINDER" KIT**

This handy device leaves your tape recorder free for operation while it rewinds tape at the rate of 1200' in 40 seconds. Prevents unnecessary wear to the tape and recorder by eliminating wear against guides and heads. It will handle up to 10 1/2" tape reels as well as 800' reels of 8 and 16 millimeter film. A very useful aid to operators of movie projection equipment. The Heathkit Speedwinder features an automatic shutoff which prevents whipping of tape when it has rewound. A manual shutoff is also provided. An automatic braking device is built in for protection against power failure. Driven by a heavy duty four pole motor. Handsome cabinet is constructed of furniture grade plywood. Step-by-step instructions are provided to make this kit easy to assemble even by one with no experience.

**COMPLETE TOOL SET**

A clear illustration of just how easy Heathkit building is. The pliers, diagonal sidecutters, two screw drivers and soldering iron are all the basic tools you need for building practically any Heathkit. Pliers and sidecutters are equipped with insulated rubber handles. The American Beauty soldering iron has a replaceable tip to facilitate cleaning. All the tools are of top quality case hardened steel for rugged duty and long life. With these simple, inexpensive tools in your hand you need not be afraid to tackle the most elaborate kit. The manual included with this handy kit provides you with many useful tips on the use and care of your tools. It shows the all important step of making proper solder connections. A truly worthwhile investment for the beginner in electronic kit building. Shpg. Wt. 3 lbs.

**HEATH COMPANY • a subsidiary of Daystrom, Inc. • Benton Harbor 15, Mich.**





# Plan Your Hi-Fi System...

AVAILABLE AFTER JUNE 30



HEATHKIT  
**SP-2**      PRICE TO BE  
ANNOUNCED

Model SP-1 (monaural)  
Model SP-2 (monaural-stereo)  
Model C-SP-1 (converts SP-1 to SP-2)

**Control both stereo  
channels simply  
and conveniently**

## MONAURAL-STEREO PREAMPLIFIER KIT

This expertly designed preamplifier provides all the controls required for either standard monaural (single channel) or stereo (dual channel) sound reproduction. Features building block design... you can start with a basic preamplifier and add a second channel for stereo later on, without rewiring. Second channel plugs in for fast conversion. The complete model SP-2 (stereo) features twelve separate inputs, six on each channel with input level controls. Six dual-concentric controls consist of: two 8-position selector switches, two bass, two treble, two volume level and two loudness controls, a scratch filter switch and a 4-position function switch (separate on-off switch). The function switch provides settings for stereo, two-channel mix, channel A or B for monaural use. Inputs consist of tape, mike, mag phono and three high-level inputs. Tape input has NARTB equalization and input selector provides for RIAA, LP, 78 record compensation. EF86 tubes are used in the input stages along with hum balance controls to assure low hum and noise. Two cathode follower outputs with level controls provided in addition to two separate tape outputs for stereo recording. A remote balance control with twenty feet of cable allows balancing the stereo system from listening position. Construction is greatly simplified through the use of two printed circuit boards (one in each channel) and encapsulated printed circuits. The beautiful vinyl clad steel cover has leather texture in black with inlaid gold design. Built-in power supply.



HEATHKIT  
**WA-P2**  
**\$1975**

**Finger-tip controls for  
your operating convenience**

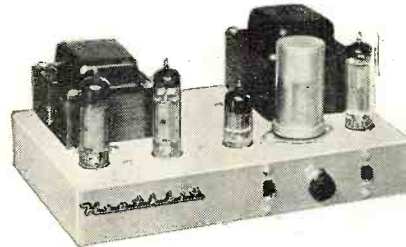

HEATHKIT  
**UA-1**  
**\$2195**

**A low cost  
versatile performer**

### "MASTER CONTROL" PREAMPLIFIER KIT

Designed as a control center for basic amplifiers the WA-P2 provides you with true high fidelity performance for the finest audio systems. Five switch-selected inputs accommodate a record changer, tape recorder, AM-FM tuner, TV receiver, microphone, etc., each with level control. Provision is also made for a tape recorder output. Ideal for "remote" installations, the WA-P2 features a low impedance cathode-follower output circuit allowing greater length of output lead. Full frequency response is obtained within  $\pm 1\frac{1}{2}$  db from 15 to 35,000 CPS and will do full justice to the finest available program sources. Equalization is provided for records through separate turnover and rolloff switches for LP, RIAA, AES, and early 78's. A special hum balance control allows setting for minimum hum level. Power for operation is required from basic amplifier or external source. Shpg. Wt. 7 lbs.

### "UNIVERSAL" 12-WATT AMPLIFIER KIT

A true high fidelity performer in every sense of the word, the UA-1 makes an ideal basic amplifier for any hi-fi system and is a perfect addition to gear your present hi-fi system for stereo sound. Uses 6BQ5/EL84 push-pull output tubes for less than 2% harmonic distortion throughout the entire audio range (20 to 20,000 CPS) at full 12 watt output. The on-off switch is located right on the chassis and an octal socket is provided for connecting a preamplifier for remote control operation. The specially designed output transformer provides excellent stability and frequency response. Taps for 4, 8 and 16 ohm speakers, with switched damping for "unity" or "maximum" on the 16-ohm tap. An input level control is provided for use in wired music systems where a preamplifier is not required. This versatile unit is the latest addition to the fine line of Heathkit basic amplifiers. Shpg. Wt. 13 lbs.



With Flexible Heathkit Components



### DELUXE AM-FM TUNER KIT

Outstanding features in both styling and circuitry are combined in this 16-tube deluxe AM-FM combination tuner to bring you the very finest in program sources, for your listening enjoyment. Features include three circuit boards for easy construction and high stability—prewired, prealigned FM front end—built-in AM rod antenna—tuning meter—AFC (automatic frequency control) with on-off switch and flywheel tuning. AM and FM circuits are separate and individually tuned making it ideal for stereo applications. Cathode follower outputs with individual controls are provided for both AM and FM. Other features include variable AM bandwidth, 10 kc whistle filter, tuned-cascode FM front end, FM AGC and amplified AVC for AM. The unique IF limiter design automatically provides the number of limiting and IF stages required for smooth non-flutter reception. The silicon diode power supply is extremely conservatively rated and is fuse protected assuring long service life. A tuning meter shows when the station is tuned-in for clearest reception on AM or FM. Use of three circuit boards greatly simplifies construction of circuit, you do only a minimum of wiring. All IF transformers and coils are prealigned so it will be ready to operate as soon as construction is completed. Appearance of this top-quality unit is further enhanced by the vinyl-clad steel cover in black with inlaid gold design. A multiplex jack is provided for addition of converter unit to receive multiplex stereo broadcasts on FM. A top dollar value.

AVAILABLE AFTER JUNE 30

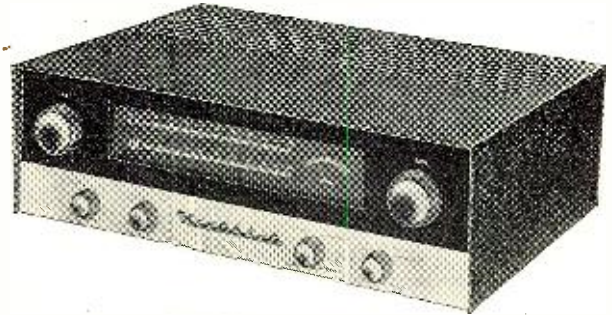

HEATHKIT  
PT-1 \$89<sup>95</sup>

**A deluxe AM-FM  
tuner combination  
loaded with extras!**

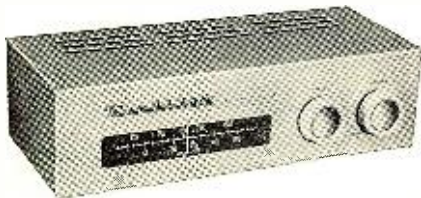

HEATHKIT  
BC-1A  
\$25<sup>95</sup>

**Wide range broadcast reception**

### HIGH FIDELITY AM TUNER KIT

This AM tuner was designed especially for high fidelity applications. It incorporates a special detector using crystal diodes, and the IF circuit features broad bandwidth to assure low signal distortion. Audio response is  $\pm 1$  db from 20 CPS to 9 kc, with 5 db of pre-emphasis at 10 kc to compensate for station rolloff. Sensitivity and selectivity are excellent and the tuner covers the entire broadcast band from 550 to 1600 kc. Quiet performance is assured by a 6 db signal-to-noise ratio at 2.5 uv. Prealigned RF and IF coils eliminate the need for special alignment equipment. Incorporates AVC, two outputs, two antenna inputs, and built-in power supply. Edge-lighted glass slide rule dial for easy tuning. Your "best buy" in an AM tuner. Shpg. Wt. 9 lbs.

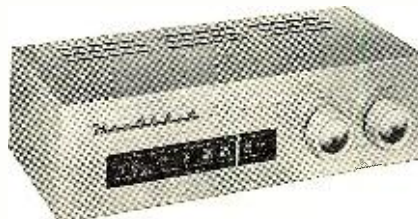

HEATHKIT  
FM-3A  
\$25<sup>95</sup>

**Enjoy static-free FM entertainment**

### HIGH FIDELITY FM TUNER KIT

FM programming, your least expensive source of high fidelity will provide you with years of real enjoyment. This beautifully styled FM tuner features broad-banded circuits for full fidelity and better than 10 uv sensitivity for 20 db of quieting to pull in stations with clarity and full volume. Covers the complete FM band from 88 to 108 mc. Stabilized, temperature-compensated oscillator assures negligible drift after initial warmup. A ratio detector provides high-efficiency demodulation without sacrificing hi-fi performance. IF and ratio transformers are prealigned, as is the front end tuning unit, making special alignment equipment unnecessary. Edge-lighted glass slide rule dial for easy tuning. You need not wait to have FM in your home at this low price. Shpg. Wt. 8 lbs.

**HEATH COMPANY** • a subsidiary of Daystrom, Inc. • **Benton Harbor 15, Mich.**



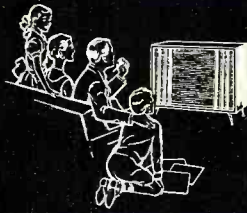

You can be sure you're buying High Fidelity

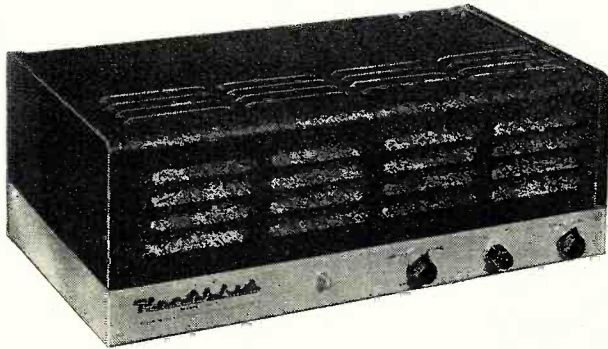

HEATHKIT  
W-7M

**\$54<sup>95</sup>**

**55 watts of hi-fi power at  
only \$1 per watt**

- ★ BEAUTIFULLY STYLED IN BLACK AND GOLD
- ★ UNITY OR MAXIMUM DAMPING

**"EXTRA PERFORMANCE"**

**55 WATT HI-FI AMPLIFIER KIT**

Another Heathkit first! An honestly rated high power amplifier with many top quality features at less than a dollar per watt. Full audio output is conservatively rated at 55 watts from 20 CPS to 20 kc with less than 2% total harmonic distortion throughout the entire range. Unique paired output connections permit instant switch selection of "unity" or "maximum" damping factors for all 4, 8 or 16 ohm speakers. Each output has an optimized current feedback circuit for unity damping so that there will be no compromise in performance when any of the impedances is used. This current feedback circuitry is entirely shorted out when not in use to obtain the highest possible damping factor. Features include level control and "on-off" switch right on the chassis plus provision for remote control from preamp, etc. Famous "bas-bal" circuit conveniently balances EL-34 output tubes. These heavy duty push-pull tubes operate into a high quality tapped-screen transformer designed especially for this unit. A 70-volt output on the transformer provides for P.A. or large music systems. The silicon diode power supply features a protection device that controls current until tubes have warmed up, greatly increasing service life of all components. The stylish black and gold case measures 6" H. x 8½" D. x 15" W. Convenient pilot light on the chassis. Thoughtful circuit layout makes this kit easy to build. Dollar for watt you can't beat this buy. Shipped express only. Shpg. Wt. 28 lbs.

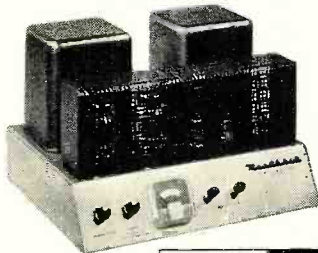

HEATHKIT  
W-6M

**\$109<sup>95</sup>**

**Plenty of Reserve Power  
Without Distortion**



HEATHKIT  
W-5M

**\$59<sup>75</sup>**

**Top-Flight Performance  
for the Critical Listener**

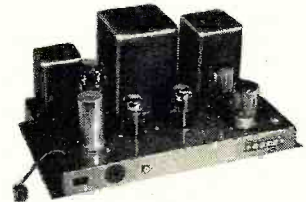

HEATHKIT  
W4-AM

**\$39<sup>75</sup>**

**Faithful Sound Reproduction  
with Minimum Investment**

**"HEAVY DUTY" 70-WATT HI-FI AMPLIFIER KIT**

Here is an amplifier that will provide the extra "push" needed to drive any of the fine speaker systems available today, for truly fine performance at any power level. Silicon-diode rectifiers are used to assure long life and a heavy duty transformer gives you extremely good power supply regulation. Variable damping control provides optimum performance with any speaker system. Quick change plug selects 4, 8 and 16 ohms or 70 volt output and the correct feedback resistance. Frequency response at 1 watt is from 5 CPS to 80 kc with controlled HF rolloff above 100 kc. At 70 watts output harmonic distortion is below 2%. 20 to 20,000 CPS and IM distortion is below 1%. 60 and 6,000 CPS. Hum and noise 88 db below full output. Metered balance circuit. Designed especially for easy assembly and years of dependable service. Shipped express only. Shpg. Wt. 52 lbs.

**25-WATT HI-FI AMPLIFIER KIT**

Considered top value in its power class by leading independent research organizations, the W-5M incorporates all the design features required by the super critical listener. Features include a specially designed Peerless output transformer and KT66 tubes. The circuit is rated at 25 watts and will follow instantaneous power peaks of a full orchestra up to 42 watts. A "tweeter saver" suppresses high frequency oscillation and a new type balancing circuit facilitates adjustment of the "dynamic" balance between output tubes. Frequency response is ±1 db from 5 CPS to 160,000 CPS at 1 watt and within 2 db from 20 to 20,000 CPS at full 25 watts output. Harmonic distortion is less than 1% at 25 watts and IM distortion is 1% at 20 watts (60 and 3,000 CPS, 4:1). Hum and noise are 99 db below 25 watts for truly quiet performance. Rich black and gold colored styling. Shipped express only. Shpg. Wt. 31 lbs.

**20-WATT HI-FI AMPLIFIER KIT**

This fine amplifier will amaze you with its outstanding performance. It features a true Williamson circuit with extended frequency response, low distortion, and low hum levels. Enjoy true hi-fi with only a minimum investment compared to other units on the market. 5881 tubes and a special Chicago-Standard output transformer are employed to give you full fidelity at minimum cost. Frequency response extends from 10 CPS to 100 kc within ±1 db at 1 watt assuring you of full coverage of the audio range. Clean, clear sound amplification takes place in circuits that hold harmonic distortion at 1.5% and IM distortion below 2.7% at full 20 watt output. Hum and noise are 95 db below full output. Taps on the output transformer are at 4, 8 or 16 ohms to match the speaker system of your choice. An outstanding performer, this investment will bring you years of listening enjoyment. Shipped express only. Shpg. Wt. 28 lbs.

*All basic amplifiers recommended for use with model WA-P2, SP-1 or SP-2 preamplifiers*



...When You Buy Heathkits

HEATHKIT

### "BOOKSHELF" 12-WATT AMPLIFIER KIT

The model EA-2 combines eye-pleasing style and color with many extra features for high quality sound reproduction. This fine amplifier provides full range frequency response from 20 to 20,000 CPS within  $\pm 1$  db. Harmonic distortion is less than 1% at full 12 watt output over the entire range (20-20,000 CPS). IM distortion is less than 1.5% at 12 watts with low hum and noise. Miniature tubes are used throughout the advanced circuitry, including EL84 output tubes in a push-pull tapped-screen output circuit using a special designed output transformer. Transformer has taps at 4, 8 and 16 ohms. The model EA-2 has its own built-in preamplifier with provision for three separate inputs, mag phono, crystal phono and tuner. The mag phono input features RIAA equalization. Separate bass and treble controls are provided with boost and cut action. A special hum-balance control assures quiet operation. The luxury styled cabinet has a smooth simulated leather texture in black with inlaid gold design and is constructed of vinyl plastic bonded to steel. It resists scuffing, wear, abrasion, and chemicals. The front panel features brushed-gold trim and buff knobs with gold inserts for a very pleasing appearance. An amber neon pilot lamp indicates when the amplifier is on. Cabinet measures 12½" W. x 3¾" D. x 4¾" H. making it suitable for use on a bookshelf, end table, etc. High quality is emphasized throughout for performance matching amplifiers costing many times more. Shpg. Wt. 15 lbs.



HEATHKIT  
EA-2

**\$27<sup>95</sup>**

**Combines beauty, style  
and quality**

- ★ LESS THAN 1% DISTORTION AT FULL OUTPUT OVER ENTIRE AUDIO RANGE.
- ★ BUILT-IN PREAMPLIFIER



HEATHKIT  
A9-C

**\$35<sup>50</sup>**

**A Bargain Package of  
Power and Performance**



HEATHKIT  
AV-3

**\$29<sup>95</sup>**

**Invaluable for  
Hi-Fi Testing**

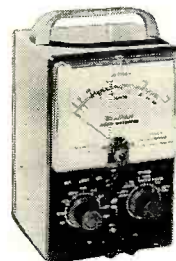

HEATHKIT  
AW-1

**\$29<sup>50</sup>**

**Measure Exact  
Power Output**

#### GENERAL-PURPOSE 20-WATT AMPLIFIER KIT

The A9-C combines a preamplifier, main amplifier and power supply all on one chassis providing a compact unit to fill the need for a good high fidelity amplifier with a moderate cash investment. Designed primarily for home installations, it is also capable of fulfilling P.A. requirements. The preamplifier section features four separate switch selected inputs. Separate bass and treble tone controls offer 15 db boost and cut. A true high fidelity performer, the A9-C covers 20 to 20,000 CPS within  $\pm 1$  db. Front panel is detachable, and can be installed on the outside of a cabinet where the chassis comes through, for custom installations. A fine unit with which to start your hi-fi system. Shpg. Wt. 23 lbs.

#### AUDIO VTVM KIT

Critical AC voltage measurements are made easy with this high quality vacuum tube voltmeter which emphasizes stability, broad frequency response and sensitivity. Features large 4½" 200 microampere meter, with increased damping in the meter circuit for stability in low frequency tests. Extremely high voltage range handles measurements from a low value of 1 millivolt to a maximum of 300 volts. AC (RMS) voltage ranges are: 0-.01, .03, .1, .3, 1, 3, 10, 30, 100 and 300 volts. Db ranges cover -52 to +52 db. Employs 1% precision multiplier resistors for maximum accuracy. High input impedance (1 megohm at 1,000 CPS). Frequency response is essentially flat from 10 CPS to 200 kc. Shpg. Wt. 6 lbs.

#### AUDIO WATTMETER KIT

Here is a fine meter to accurately measure output wattage. Five power ranges cover 0-5 mw, 50 mw, 500 mw, 5 w and 50 w full scale. Five switch selected db ranges cover -10 db to +30 db. All indications are read directly on the large 4½" 200 ua meter. Frequency response is  $\pm 1$  db from 10 CPS to 250 kc. External or internal load resistors are selected with convenient front panel switch. Non-inductive load resistors are built in for 4, 8, 16 or 600 ohms impedance. Precision multiplier resistors are used for high accuracy and incorporates a crystal diode bridge for wide-range frequency response. Modern styling and convenient front panel design. Cabinet is ventilated to allow efficient cooling of load resistors. Shpg. Wt. 7 lbs.

**HEATH COMPANY • a subsidiary of Daystrom, Inc. • Benton Harbor 15, Mich.**





Easy to Buy - Easy to Build - Easy to Use...



CONTEMPORARY  
Model CE-1B Birch  
Model CE-1M Mahogany

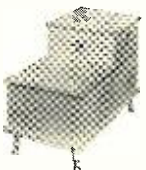

TRADITIONAL  
Model CE-1T Mahogany

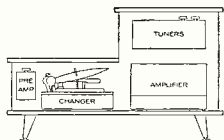

HEATHKIT  
CE-1  
**\$43<sup>95</sup>**  
each

### CHAIRSIDE ENCLOSURE KIT

This Chairside Enclosure lets you combine all of your hi-fi equipment into one compact control center and, at the same time add a beautiful piece of furniture to your home. The CE-1 is designed to house the AM and FM tuners (BC-1A and FM-3A) and the WA-P2 preamplifier along with the majority of record changers which will fit into the space provided. Adequate room is available in the rear of the unit to house any of the Heathkit amplifiers designed to operate with the WA-P2. The enclosure is flexible enough to give you a large choice in component installation. If only one tuner and the preamplifier are used, the two units can be installed in the tilt-out drawer, or if more convenient, either unit can be placed in the space provided in front of the changer compartment. The tilt-out shelf can be installed on either right or left side and the lift-top lid is similarly designed to lift from either side depending on your choice during construction. Good ventilation is achieved through appropriately placed slots in the bottom and back of the enclosure. Overall dimensions are 18" W. x 24" H. x 35½" D. The changer compartment measures 17¾" L. x 16" W. x 9¾" D. All parts are pre-cut and pre-drilled for easy assembly and attractive hardware is supplied to match each style. The contemporary cabinet is available in either mahogany or birch and the traditional cabinet is available in mahogany only. Furniture grade plywood can be finished to your taste. Shpg. Wt. 46 lbs.

**Combine all your Hi-Fi equipment  
in this attractive cabinet**



HEATHKIT  
AG-9A **\$34<sup>50</sup>**

**Your own source of  
Hi-Fi audio signals**

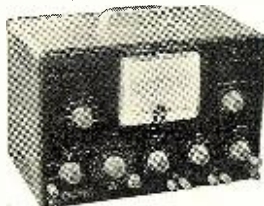

HEATHKIT  
AA-1 **\$49<sup>95</sup>**

**3 Audio test instruments  
in one compact unit**



HEATHKIT  
HD-1 **\$49<sup>50</sup>**

**Check amplifier  
distortion quickly**

#### AUDIO SIGNAL GENERATOR KIT

The model AG-9A is "made to order" for high fidelity applications, and provides quick and accurate selection of low-distortion signals from 10 CPS to 100 kc. Three rotary switches select two significant figures and a multiplier to determine audio frequency. Incorporates step-type and continuously variable output attenuator. Output indicated on large 4½" panel meter, calibrated in volts and db. Attenuator system operates in 10 db steps, corresponding to meter calibration, in ranges of 0-.003, .01, .03, .1, .3, 1, 3 and 10 volts RMS. "Load" switch permits use of built-in 600-ohm load, or external load of different impedance. Output and frequency indicators accurate to within ± 5%. Distortion less than .1 of 1% between 20 and 20,000 CPS. Shpg. Wt. 8 lbs.

#### AUDIO ANALYZER KIT

Complete high fidelity testing facilities are yours in the AA-1. It combines the functions of three separate instruments; an AC VTVM, audio wattmeter and a complete IM analyzer with filters and high and low frequency oscillators built in. VTVM ranges are: 0-.01, .03, .1, .3, 1, 3, 10, 30, 100 and 300 volts (RMS). dB scale reads from -65 to +52 dbm. Wattmeter ranges are: .15 mw, 1.5 mw, 15 mw, 150 mw, 1.5 w, 15 w and 150 w. IM scales are 1%, 3%, 10%, 20% and 100% full scale. Provides internal load resistors of 4, 8, 16 or 600 ohms. Combining and consolidating functions reduces the number of test leads and controls required for the same test. Complete instructions are provided for easy assembly, also valuable information on use of instrument. Shpg. Wt. 13 lbs.

#### HARMONIC DISTORTION METER KIT

Valuable in both designing and servicing of audio circuits, the HD-1 used with an audio signal generator, will accurately measure harmonic distortion at any or all frequencies between 20 and 20,000 CPS. Distortion is read on panel meter in ranges of 0-1, 3, 10, 30 and 100% full scale. Full scale voltage ranges of 0-1, 3, 10 and 30 volts are provided for the initial reference settings. Signal-to-noise ratio is measured on a separate meter scale calibrated in db. Features high input impedance (300,000 ohms) and 1% precision resistors in the VTVM voltage divider circuit for excellent sensitivity and accuracy. High quality components insure years of dependable service. Complete instructions provided for easy assembly and operation. Shpg. Wt. 13 lbs.



Heathkits are Your Best Dollar Value



### TRANSISTOR PORTABLE RADIO KIT

The overwhelming sales of this outstanding transistor portable have made a substantial price reduction possible... in addition, an all new plastic molded case adds the finishing touch to the exceptional circuitry. Six name-brand (Texas Instrument) transistors are used for extra good sensitivity and selectivity. The 4" x 6" PM speaker with heavy magnet provides excellent tone quality. Use of this large speaker and roomy chassis make it unnecessary to crowd components adding greatly to the ease of construction. Transformers are prealigned so it is ready for service as soon as construction is completed. A touchup in alignment is easily accomplished on a station by following simple instructions in manual. Alignment tool furnished. Has built-in rod-type antenna for reception in all locations. Six standard size "D" flashlight cells are used for extremely long battery life (between 500 and 1000 hours) and they can be purchased almost anywhere. Cabinet is two-tone blue molded plastic with pull-out carrying handle. Dimensions are 9½" L. x 7¼" H. x 4" D. Shpg. Wt. 6 lbs.

Model XR-1-L: Identical to XR-1-P except in genuine leather case. Rich, warm sun-tan tone. Leather carrying strap included. Shpg. Wt. 7 lbs.

Leather Case: can be purchased separately if desired. Fits all XR-1P's and XR-1's. No. 93-1. Shpg. Wt. 3 lbs. \$6.95.

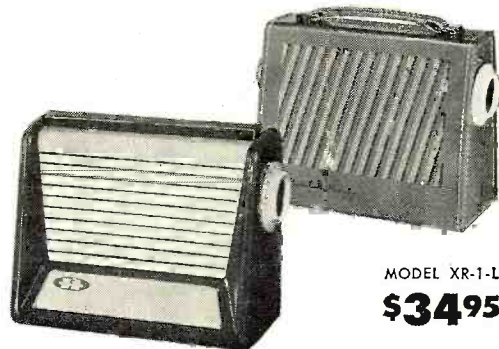

MODEL XR-1-L  
**\$34.95**

HEATHKIT  
XR-1-P **\$29.95**

**Newly designed plastic case... new low price!**

- ★ 4" X 6" SPEAKER FOR "BIG SET" TONE
- ★ LONG BATTERY LIFE (500 to 1000 Hours)



HEATHKIT  
CT-1  
**\$7.95**

**Test condensers right in the circuit**



HEATHKIT  
DF-1 **\$54.95**

**Pin-point your exact location**



HEATHKIT  
FD-1 **\$35.95 each**  
(6 volt model FD-1-6)  
(12 volt model FD-1-12)

**Detects gas fumes**



HEATHKIT  
MC-1  
**\$42.95**

**Save your boat batteries**

#### IN-CIRCUIT CAPACI-TESTER KIT

Check most capacitors for "open" or "short" right in the circuit with this handy kit. Detects open capacitors from about 50 mmf up, not shunted by an excessively low resistance value. Checks shorted capacitors up to 20 mfd (not shunted by less than 10 ohms). (Does not detect leakage nor check electrolytic condensers.) Employs a 60-cycle frequency for the short test and a 19 megacycle frequency for the open test. Uses electron beam "eye" tube for quick indication. Test leads included. Shpg. Wt. 5 lbs.

#### TRANSISTOR RADIO DIRECTION FINDER KIT

This transistor radio compass will double as a portable radio. Covers the standard broadcast band from 540 to 1600 kc. Ideal for use aboard boats and also on land by hunters, hikers, etc. A directional high-Q ferrite antenna rotates from the front panel to obtain a fix on a station. A 1 ma meter serves as null and tuning indicator. Prealigned IF transformers—six transistor circuit. Powered by tiny 9-volt battery with spare included. Dimensions 7½" W. x 5¾" H. x 5¾" D. Shpg. Wt. 5 lbs.

#### FUEL VAPOR DETECTOR KIT

Protect your boat and passengers against fire and explosion with one of these fuel vapor detector kits. Indicates the presence of fumes on a three-color "safe-dangerous" meter scale and immediately shows if it is safe to start the engine. A pilot lamp shows when the detector is operating. Easy to build and install, even by one not having previous experience. Operates from your boat battery. The kit is complete with heavy-duty neoprene insulated cable and includes spare detector unit. Shpg. Wt. 4 lbs.

#### MARINE CONVERTER KIT

Charge 6 or 12 volt batteries with this marine converter and battery charger. A panel mounted 25 ampere meter continuously monitors the charging current. Moisture and fungus proofed for rugged marine use. Convection cooling prevents unsafe temperature rise. The MC-1 has no moving parts, tubes nor blowers to wear out or break. Mounting brackets are supplied for easy installation on any boat. Ideal for keeping batteries fully charged or to supply extra current for appliances. Shpg. Wt. 16 lbs.

**HEATH COMPANY • a subsidiary of Daystrom, Inc. • Benton Harbor 15, Mich.**



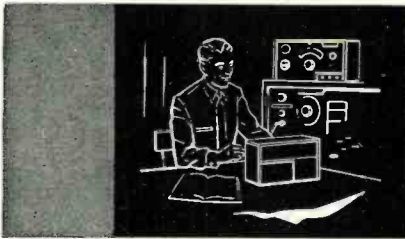

New Styling - New Features...



HEATHKIT  
TX-1 **\$229.50**

**Complete Versatility for Top-Notch Amateur Communications**

- ★ NEWLY DESIGNED VFO—ROTATING SLIDE RULE DIAL
- ★ MODERN STYLING—PROVISION FOR SSB ADAPTER

**"APACHE" HAM TRANSMITTER KIT**

Fresh out of the Heath Company laboratories, the brand-new "Apache" model TX-1 ham transmitter features modern styling and the latest in circuitry for extra fine performance. The "Apache" is a high quality transmitter operating with a 150 watt phone input and 180 watt CW input. In addition to CW and phone operation, built-in switch selected circuitry provides for single-sideband transmission through the use of a plug-in external adapter. These SSB adapters will be available in the near future. A compact, stable and completely redesigned VFO provides low drift frequency control necessary for SSB transmission! A slide rule type illuminated rotating VFO dial with vernier tuning provides ample bandspread and precise frequency settings. The bandswitch allows quick selection of the amateur bands on 80, 40, 20, 15 and 10 meters. (11M with crystal control). This unit also has adjustable low level speech clipping and a low distortion modulator stage employing two of the new 6CA7/EL-34 tubes in push-pull class AB operation. Time sequence keying is provided for "chirpless" break-in CW operation. The final amplifier is completely shielded for greater TVI protection and transmitter stability. Die-cast aluminum knobs and front panel escutcheons add to the attractive styling of the transmitter. Pi network output coupling matches antenna impedances between 50 and 72 ohms. Shpg. Wt. 115 lbs.

\$50.00 deposit required on C.O.D. orders. Shipped motor freight unless otherwise specified.



HEATHKIT  
DX-20 **\$35.95**

**An Ideal Code Transmitter**



HEATHKIT  
DX-100 **\$189.50**

**You'll be Proud to Own This Outstanding Performer**



HEATHKIT  
DX-40 **\$64.95**

**Phone & CW Facilities at Low Cost**

**DX-20 CW TRANSMITTER KIT**

Designed especially for CW work, the DX-20 features high efficiency at low cost. An ideal rig for the novice or advanced-class CW operator. Plate power input is 50 watts, and covers 80, 40, 20, 15, 11 and 10 meters with single knob bandswitching. Features a single 6DQ6A tube in the final amplifier stage and a 6CL6 as a crystal oscillator. Pi network output circuit matches various antenna impedances between 50 and 1000 ohms and reduces harmonic output. Top-quality parts are featured throughout, including "potted" transformers, etc., for long service life. Complete shielding to minimize TVI. Removable metal pull-out plug on left end of cabinet provides access for crystal changing. Very easy to build with complete instructions supplied. Shpg. Wt. 19 lbs.

**DX-100 PHONE AND CW TRANSMITTER KIT**

Well known for its high quality and fine performance the DX-100 features a built-in VFO, modulator, and power supply, complete shielding to minimize TVI, and a pi network coupling to match impedances from 50 to 600 ohms. RF output is in excess of 100 watts on phone and 120 watts on CW, for clean strong signals on all ham bands from 10 to 160 meters. Single knob bandswitching and illuminated VFO dial and meter face add real operating convenience. RF output stage uses a pair of 6146 tubes in parallel, modulated by a pair of 1625's. High quality components are used throughout, such as potted transformers, silver-plated or solid coin silver switch terminals, aluminum-heat dissipating caps on the final tubes, copper plated chassis, etc. Shpg. Wt. 107 lbs.

\$50.00 deposit required on C.O.D. orders. Shipped motor freight unless otherwise specified.

**DX-40 PHONE AND CW TRANSMITTER KIT**

An outstanding buy in its power class the DX-40 provides both phone and CW operation on 80, 40, 20, 15, 11 and 10 meters. A single 6146 tube is used in the final amplifier stage to provide full 75 watt plate power input on CW, or controlled carrier modulation peaks up to 60 watts for phone operation. Modulator and power supplies are built in and single-knob bandswitching is combined with the pi network output circuit for complete operating convenience. Complete shielding to minimize TVI. Provision is made for three crystals. A four-position switch selects any of the three crystals or a jack for external VFO. Crystal sockets are reached through access door in rear of cabinet. High quality D'Arsonval movement panel meter. Shpg. Wt. 25 lbs.



For Real Ham Enjoyment

HEATHKIT

**"MOHAWK" HAM RECEIVER KIT**

Here is a ham receiver that any radio operator would be proud to own. The "Mohawk" has all the functions required for high quality communications with clear, rock-steady reception on all bands. This 15-tube receiver features double conversion with IF's at 1682 kc and 50 kc and covers all of the amateur frequencies from 160 through 10 meters on seven bands with an extra band calibrated to cover 6 and 2 meters using a converter. Receiver accommodations are provided for these converters which will be available in Heathkits soon. The "Mohawk" is specially designed for single-sideband reception with crystal controlled oscillators for upper and lower sideband selection. A completely preassembled, wired and aligned front end coil assembly assures ease of construction and top performance of the finished unit. Other features include five selectivity positions from 5 kc to 500 CPS, bridged T-notch filter for maximum heterodyne rejection, and a built-in 100 kc crystal calibrator. The set provides a 10 db signal-to-noise ratio at less than 1 microvolt input. Front panel features S meter, separate RF, IF and AF gain controls, T-notch tuning, T-notch depth, ANL, AVC, BFO, bandswitch, tuning, antenna trimmer, calibrate set, calibrate on, CW-SSB-AM, receive-standby, upper-lower sideband, selectivity, phone jack and a wide band rotating slide rule type vernier tuning dial with easy to read calibrations. Shpg. Wt. 90 lbs. \$50.00 required on C.O.D. orders. Shipped motor freight unless otherwise specified.



HEATHKIT RX-1 **\$274<sup>95</sup>**

**Now in Kit Form a Top Quality Ham Band Receiver**

- ★ PREWIRED AND ALIGNED FRONT END COIL ASSEMBLY.
- ★ CRYSTAL CONTROLLED OSCILLATORS FOR DRIFT-FREE RECEPTION.



HEATHKIT B-1 **\$8<sup>95</sup>**

**Get Proper Match Between Transmitter and Antenna**

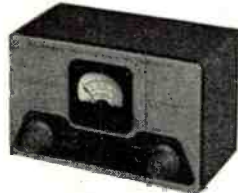

HEATHKIT AM-2 **\$15<sup>95</sup>**

**Measure Standing Wave Ratio**



HEATHKIT VX-1 **\$23<sup>95</sup>**

**Eliminates Hand Switching**

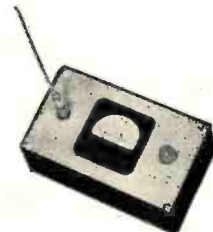

HEATHKIT PM-1 **\$14<sup>95</sup>**

**Quick Check of Transmitter Operation**

**BALUN COIL KIT**

Unbalanced coax lines used on the most modern transmitters can be matched to balance lines of either 75 or 300 ohms impedance by using the model B-1 Balun Coil Kit. Can be used with transmitters and receivers without adjustment over the frequency range of 80 through 10 meters, and will handle power inputs up to 200 watts. Cabinet size is 10" square by 5" D. and may be located any distance from the transmitter or antenna. A protective cover is supplied to prevent damage in outdoor installations. Shpg. Wt. 4 lbs.

**REFLECTED POWER METER KIT**

The match of your antenna transmission system can be checked by measuring the forward and reflected power or standing wave ratio from 1:1 to 6:1 with this fine unit. Designed to handle a peak power of well over 1 kilowatt of energy the AM-2 may be left in the antenna system feed line at all times. Band coverage is 160 meters through 2 meters. Input and output impedances for 50 or 75 ohm lines. No external power required for operation. Cabinet size is 7 1/8" x 4 1/8" x 4 1/8". Shpg. Wt. 3 lbs.

**ELECTRONIC VOICE CONTROL KIT**

This unique device allows you to switch from receiver to transmitter merely by talking into your microphone... you get the advantage of "telephone-type conversation" as in single sideband but with regular AM transmission. The unit is adjustable to all conditions by sensitivity controls provided. A variable time delay control changes the "hold" time. Provision is made for receiver and speaker connections and also for a 117 volt antenna relay. Built-in power supply. Complete instructions provided. Shpg. Wt. 5 lbs.

**RF POWER METER KIT**

This self contained unit requires no power for operation. You simply place it close to the transmitter antenna to sample the RF field which is then indicated on the panel meter. Operates with any transmitter having an output frequency between 100 kc and 250 mc, regardless of power. Sensitivity is 0.3 volts RMS full scale, and a special control on the panel allows for further adjustment of the sensitivity. Measures 3 1/4" W. x 6 1/4" L. x 2" D. An easy way to put your mind at ease concerning transmitter operation. Shpg. Wt. 2 lbs.

**HEATH COMPANY • a subsidiary of Daystrom, Inc. • Benton Harbor 15, Mich.**





# Choose from a wide variety of Heathkits

## DUAL-CHASSIS 20 WATT HI-FI AMPLIFIER KIT

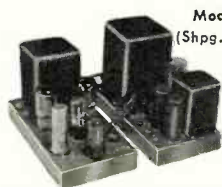

Model W3-AM  
(Shpg. Wt. 29 lbs.)

**\$49<sup>95</sup>**

## 12" UTILITY SPEAKER



Model 401-6  
(Shpg. Wt. 7 lbs.)

**\$7<sup>50</sup>**

## ALL-BAND RADIO KIT



Model AR-3  
(Shpg. Wt. 12 lbs.)

**\$29<sup>95</sup>**  
(less cabinet)

## CRYSTAL RADIO KIT



Model CR-1  
(Shpg. Wt. 3 lbs.)

**\$7<sup>95</sup>**

## BROADCAST BAND RADIO KIT



Model BR-2  
(Shpg. Wt. 10 lbs.)

**\$18<sup>95</sup>**  
(less cabinet)

## ELECTRONIC CROSSOVER KIT



Model XO-1  
(Shpg. Wt. 6 lbs.)

**\$18<sup>95</sup>**

## "Q" MULTIPLIER KIT



Model QF-1  
(Shpg. Wt. 3 lbs.)

**\$9<sup>95</sup>**

## "AUTOMATIC" CONELRAD ALARM KIT



Model CA-1  
(Shpg. Wt. 4 lbs.)

**\$13<sup>95</sup>**

## GRID DIP METER KIT



Model GD-1B  
(Shpg. Wt. 4 lbs.)

**\$21<sup>95</sup>**

## VIBRATOR POWER SUPPLY KIT



6 volt Model VP-1-6  
12 volt Model VP-1-12  
(Shpg. Wt. 4 lbs.)

**\$7<sup>95</sup>**  
ea.

## VARIABLE FREQUENCY OSCILLATOR KIT



Model VF-1  
(Shpg. Wt. 7 lbs.)

**\$19<sup>50</sup>**

## PROFESSIONAL RADIATION COUNTER KIT

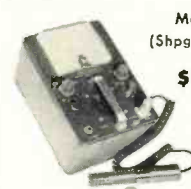

Model RC-1  
(Shpg. Wt. 8 lbs.)

**\$79<sup>95</sup>**

## ISOLATION TRANSFORMER KIT



Model IT-1  
(Shpg. Wt. 9 lbs.)

**\$16<sup>50</sup>**

## ELECTRONIC SWITCH KIT



Model S-3  
(Shpg. Wt. 8 lbs.)

**\$21<sup>95</sup>**

## REGULATED POWER SUPPLY KIT



Model PS-3  
(Shpg. Wt. 17 lbs.)

**\$35<sup>50</sup>**

## VOLTAGE CALIBRATOR KIT



Model VC-3  
(Shpg. Wt. 4 lbs.)

**\$12<sup>50</sup>**

## DIRECT-READING CAPACITY METER KIT



Model CM-1  
(Shpg. Wt. 7 lbs.)

**\$29<sup>50</sup>**

## TUBE CHECKER KIT



Model TC-2  
(Shpg. Wt. 12 lbs.)

**\$29<sup>50</sup>**

## EASY TIME PAYMENTS

AVAILABLE FOR YOUR  
CONVENIENCE...

Any order totaling \$90 or more can be paid for in small monthly payments (send for complete details).

## RESISTANCE SUBSTITUTION BOX KIT



Model RS-1  
(Shpg. Wt. 2 lbs.)

**\$5<sup>50</sup>**

## CONDENSER SUBSTITUTION BOX KIT

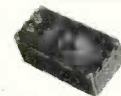

Model CS-1  
(Shpg. Wt. 2 lbs.)

**\$5<sup>50</sup>**

## CATHODE RAY TUBE CHECKER KIT



Model CC-1  
(Shpg. Wt. 10 lbs.)

**\$24<sup>95</sup>**

## LABORATORY RF GENERATOR KIT



Model LG-1  
(Shpg. Wt. 16 lbs.)

**\$48<sup>95</sup>**

## "Q" METER KIT



Model QM-1  
(Shpg. Wt. 14 lbs.)

**\$44<sup>50</sup>**

## DECADE CONDENSER KIT

Model DC-1  
(Shpg. Wt. 3 lbs.)

**\$16<sup>50</sup>**

## DECADE RESISTANCE KIT

Model DR-1  
(Shpg. Wt. 4 lbs.)

**\$19<sup>50</sup>**









**NOW AVAILABLE**  
... a quality line of  
exact replacement magnetic  
tape heads ...

**INCLUDING STEREO!**

*You owe it to your  
Customers-*

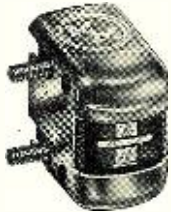

5B20



5L20U



3L20S

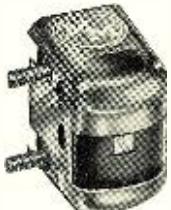

10L17

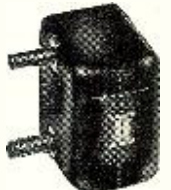

7EM12

**TO INSPECT AND RE-  
PLACE RECORDING  
HEADS BEFORE TONAL  
BRILLIANCE IS LOST**

In five-hundred hours or less of operation, high frequency response can fall off to a measurable degree due to the abrasive action of the tape passing over the head in the presence of normal amounts of dust in the air. If visual inspection discloses excessive wear on the active surface of the head, your customer will appreciate your replacing this unit with an MM head to enhance his listening pleasure and protect his tapes.

**THE  
MICHIGAN  
MAGNETICS  
LINE ...**

NO.		LIST PRICE
5B20	Stereo	\$22.50
5B20LS	Stereo	22.50
10B20LS	Stereo	22.50
5L20U		8.50
3L20S		7.50
	Also replaces 2L35 & 2M40	
10L17		8.50
10L17S		7.50
	Also replaces 9L20S & 10M20A	
40EM12		6.00
7EM12		6.00

*Order today*

**OR WRITE FOR ANY ADDITIONAL  
INFORMATION YOU MAY REQUIRE!**



**DISTRIBUTOR INQUIRIES INVITED**

# New G-E FM Detector

By **CHRISTOPHER BURNS**

*"New" technique harks back to old slope-detection method; single tube detects and amplifies audio.*

**S**INCE the introduction of the original gated-beam FM detector (6BN6, etc.), TV receiver and tube manufacturers have been devoting considerable attention to streamlining the sound section of the TV set. As a result, we now have more than one way, within the limits of a single tube envelope, of detecting the FM i.f. signal and bringing it up to a sufficient level so that it may feed a high-sensitivity output tube directly. This reduces the entire separate sound section to no more than three tubes and, in cases where the intercarrier signal feeds the detector directly without an i.f. amplifier, to only two tubes.

The newest practical technique for accomplishing this goal is the so-called "Delta Sound System," used in the new *General Electric Q3* receivers. Actually, this method relates to slope detection, one of the earliest and simplest techniques for recovering audio signal from an FM carrier. The basis of the method is the conversion of frequency modulation to amplitude modulation. Once this is done, conventional AM detection is all that is needed to produce a usable audio signal.

To achieve the desired conversion, the FM signal is applied to a resonant circuit that is tuned slightly away from the center carrier frequency. The response of such a circuit is shown in (B) of the diagram. As a result of the offset tuning, the 4.5-mc. carrier actually falls on the slope of the curve.

The TV FM signal is modulated  $\pm 25$  kc. above and below the center carrier. The two extremes of excursion, 4.475 mc. and 4.525 mc., are also marked along the slope shown in (B). Note that the slope is quite linear over the limits of this excursion. Now if we take a signal that is constantly varying in frequency within these limits—as is the FM i.f.—but whose amplitude is uniform, and we apply it

to a circuit with the response shown, uniformity of amplitude will be lost. That is to say, components of this signal that fall below the i.f. in frequency will receive more amplification; while those that are higher in frequency, since they will be farther down the slope, will receive less. Since the slope is linear, we will have amplitude variations that correspond to the original frequency variations. Thus we have our wish—amplitude modulation.

Before performing this conversion, we must make quite certain that the original signal has no amplitude variations, so that the AM we end up with is strictly the result of original frequency modulation. To get rid of any undesired amplitude changes, the signal, before it is detected along a slope, is fed to a limiter. In the *G-E* circuit, (A) in the diagram, the audio i.f. is first fed to the plates of diode  $V_{318}$ , which act as a compressor or clipper. After most of the AM is eliminated in this circuit, the i.f. is fed through  $C_{307}$  to the tank circuit formed by  $L_{302}$  and  $C_{308}$ . This tank is tuned as shown in (B). The AM signal that results then goes to the grid of the triode section.

The triode is so biased that it conducts only on the upper half-cycle of signal fed to it; thus the signal appearing at the triode plate is an amplified and rectified version of the signal at the grid. The audio envelope is recovered by the filtering action of the resistance and capacitance in the plate circuit. These components also provide for the required de-emphasis. As a result, recovered audio appears across the volume control.

Since some original AM remains in the compressed or limited i.f. signal after the action of the diode clipper, it is necessary to feed back some signal from the triode to cancel this residue.  $R_{305}$ , which is adjusted for best sound with minimum buzz, controls the amount of feedback applied. —30—

(A) The limiter-detector-amplifier circuit. (B) Grid-circuit response.

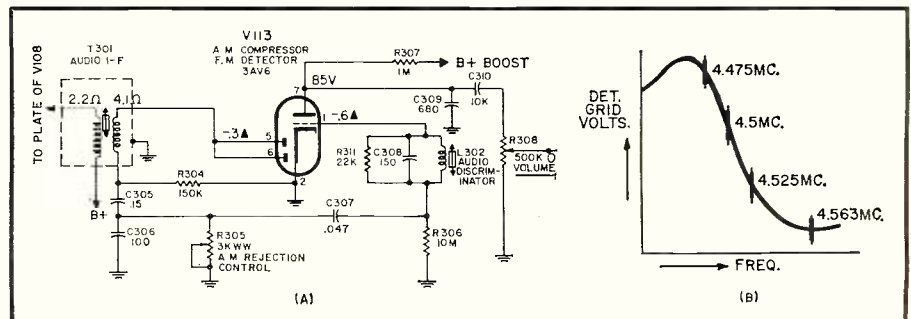



WHERE WILL YOU BE IN

# Electronics

6 MONTHS FROM TODAY?

add technical training to your practical experience

get your FCC license quickly!

then use our effective job-finding service

Get These Valuable Booklets FREE . . .

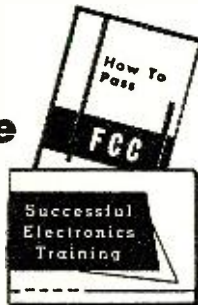

## Get Your FCC Commercial license — or your money back

The Master Course in Electronics will provide you with the mental tools of the electronics technician and prepare you for a First Class FCC License (Commercial) with a radar endorsement. When you successfully complete the Master Course, if you fail to pass the FCC examination, you will receive a full refund of all payments.

### Employers Make Offers Like These To Our Trainees Every Month!

**Service Technician** — Man needed in Cleveland, Ohio, to service and maintain electronic medical instruments and equipment. Must have a solid knowledge of electronic fundamentals. A car is required. Company benefits include retirement plan.

**Calibration Engineers** — Avco Manufacturing Corp. (Ohio) is seeking Calibration Engineers to perform final system tests and evaluation on complex electronic equipment and assemblies, primarily airborne fire control systems. Requires the knowledge of advanced electronics equivalent to two years of a Technical School. Service experience in radar maintenance and repair desired.

Name and Address	License	Time
John H. Johnson, Boise City, Okla.	1st	20 weeks
Prentice Harrison, Lewes, Del.	1st	27 weeks
Raymond L. Gersig, Pittsburgh, Pa.	2nd	24 weeks
Francis W. Bartley, Danbury, Conn.	2nd	15 weeks
Herbert W. Clay, Phoenix, Ariz.	2nd	22 weeks

(Names and addresses of trainees in your area sent on request)

Accredited by the National Home Study Council

### Cleveland Institute of Radio Electronics

Desk RN-18, 4900 Euclid Ave., Cleveland 3, Ohio

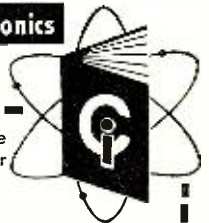

## "Complete satisfaction"

"I am happy to inform you that I passed the 2nd class radio telephone license exam on May 17. Upon receipt of the license, I took the radio-telegraph 2nd class exam, and once again I am pleased to report the success.

How can I express anything but complete satisfaction with the training I received? The examinations themselves seemed just like an extension of the Cleveland Institute course. I couldn't have been better prepared. I shall be sure to recommend your course to anyone I ever find who are struggling to learn radio, as I was just a few months ago."

Frank R. Griffiths  
Playa Del Rey, Calif.

good training doesn't cost . . . it pays!

### CLEVELAND INSTITUTE OF RADIO ELECTRONICS

Desk RN-18 4900 Euclid Bldg. Cleveland 3, Ohio

June, 1958

Please send Free Booklets prepared to help me get ahead in Electronics. I have had training or experience in Electronics as indicated below:

- |   |   |
|---|---|
| <input type="checkbox"/> Military           | <input type="checkbox"/> Broadcasting       |
| <input type="checkbox"/> Radio-TV Servicing | <input type="checkbox"/> Home Experimenting |
| <input type="checkbox"/> Manufacturing      | <input type="checkbox"/> Telephone Company  |
| <input type="checkbox"/> Amateur Radio      | <input type="checkbox"/> Other              |

In what kind of work are you now engaged? .....

In what branch of Electronics are you interested? .....

Name .....

Age .....

Address .....

City .....

Zone .....

State .....

RN-18



**HARVEY** has it...  
FOR IMMEDIATE DELIVERY

THE LATEST FROM *Collins*

*Collins* **KWM-1**

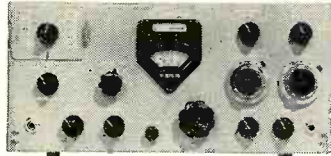

first SSB transceiver for *complete Mobile or Fixed use*

The revolutionary KWM-1, the first mobile transceiver to offer SSB. And this 14-30 mc 175 watt package is equally adaptable to fixed use with simple removal from a convenient mounting tray under the dashboard.

Utilization of common components in both transmitting and receiving functions results in a saving of both space and cost and, in the case of frequency-determining components, assures exact coincidence of transmitted and received signals. Frequency stability and readability is comparable to that of the KWS-1/75A-4. The panel meter serves as an S-meter during receive and multimeter during transmit. Break-in CW using VOX circuits is built-in, as is a side tone for monitoring CW. Ten 100 Kc bands are available anywhere in the 14-30 mc range.

**NET PRICES**

KWM-1 Transceiver .....	\$820.00
516E-1 12 vdc Power Supply .....	262.00
516F-1 115 vac Power Supply .....	136.00
312B-2 Speaker Console with phone patch and directional wattmeter .....	185.00
312B-1 Speaker in cabinet .....	25.00
351D-1 Mobile Mounting Tray .....	86.00

Also in stock the complete Collins line of ham gear.

**TRANSCON**

A complete mobile phone station in your car! Simply connect to your car radio. Choose 6 or 10 meter band model. Ideal for CD. Only 5x5x7 in. Choice of 6V or 12V types. Easily installed. **\$99.50**

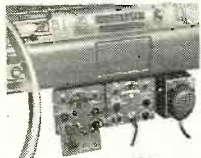

This compact TNS (4x2 1/4 x 2 1/4 in.) features a 12AX7 and 6AL5, powered by your car radio. **\$12.95**

A small (4x2 1/4 x 2 1/4 in.), simple Field Strength Meter for mobile or ham use. Only **\$11.95**



**Cesco** **STANDING WAVE REFLECTOMETER**

FOR 52-OHM COAX

Here's a high quality device for continuous measurement of standing waves on transmission lines. Suitable for frequency range from 3 to 200 mc. See the article in QST June '57

Complete, with instructions **\$29.95**

**FEATURES:** Uses sensitive 0-100 microamp meter • For continuous line insertion • Power to 1000 watts and over • Prevents false loading from antenna tuner, match box, PI network • SWR observed immediately at all times without adjustment •

Whether you have an APO or foreign address HARVEY's excellent packing and shipping department assures you of perfect arrival of merchandise anywhere in the world.

Prices Net, F. O. B., N. Y. C. Subject to change without notice

Established 1927  
**HARVEY RADIO CO., INC.**  
103 West 43rd St., New York, N. Y.  
Judson 2-1500

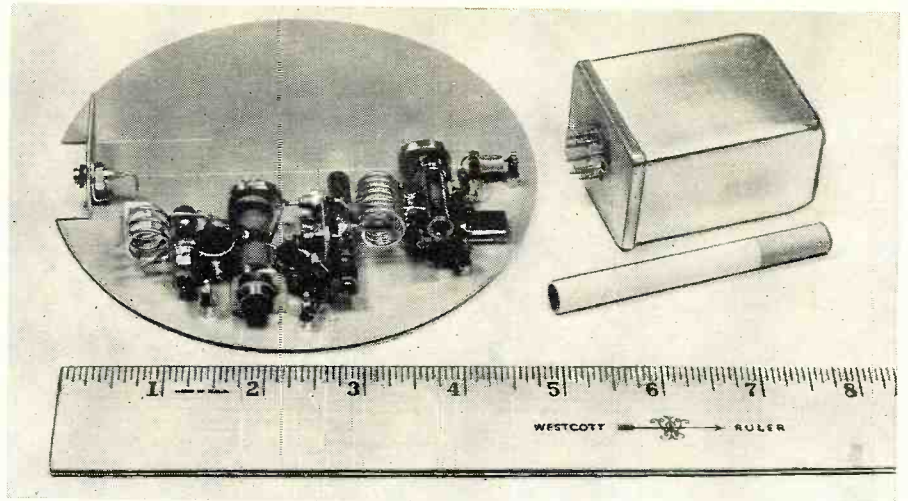

Tiny transmitter is mounted on circular plate for inclusion in satellite or missile. A somewhat more compact optional packaging arrangement is at the right.

**New Transmitter For U. S. Satellite**

*Tiny 3-oz. 3-transistor unit produces 1/2 watt with only 1/5th battery power needed for tube-type circuit.*

FUTURE U. S. satellites can continue broadcasting outer space data to earth 1 1/2 to 4 times as long as is presently possible, as a result of the development of a new transmitter by engineers of the *DuKane Corp.*, St. Charles, Ill., under contract to the Naval Research Laboratory.

The transmitter was developed as a 500 milliwatt version of NRL's 100 mw. satellite transmitter. In designing the new transmitter the engineers achieved a better efficiency as well as the desired power level. Although the circuit works well, months of extensive development and testing will be required before it can be programmed into an actual satellite or missile.

The crystal-controlled transmitter employs three recently developed *Western Electric* transistors capable of operating as oscillators or amplifiers at 108 mc. The special circuits employed give much greater over-all efficiency than is now possible with vacuum tubes. A comparable tube

transmitter requires five times the battery power needed by the transistor version.

In satellite programs, this means a highly significant saving in weight, since fewer batteries can do the same amount of work. Or, using the same batteries, the satellite transmitter can broadcast for a much longer period of time.

The tiny "broadcasting station" weighs less than 3 ounces and occupies less than 6 cubic inches of space (a cigarette package occupies about 7 cu. in.).

Typically, the output stage of a conventional tube-type transmitter doing the same job would need 4620 mw. power to produce 500 mw. output. By contrast, the output stage of the new transmitter needs only 930 mw. power to produce the same output. The corresponding efficiencies are 11 per-cent and 54 per-cent. The new circuit operates on a single 20- to 24-volt battery.

-30-



Research team which developed satellite transmitter is shown here testing the tiny 3-ounce transmitter in the laboratory.



JUST OFF THE PRESS!



WHERE  
Would You  
be Today  
in Radio-TV  
Electronics  
IF...

you had sent for  
this FREE Valuable Booklet 12 Months Ago?

TAKE A MINUTE TO MAIL THIS COUPON FOR FREE BOOKLET!

Thousands of men *did* send for it. They *read* it. And now they are a full year ahead in their march toward:

- a better job
- better pay
- promotion
- greater security
- greater confidence
- better living for self and family

All these benefits can be yours . . . if you act now to see what the rapidly expanding field of Electronics offers you. Take that first big step this minute. No obligation whatsoever. Mail coupon today, or write: Capitol Radio Engineering Institute, Dept. 116-Y, 3224 16th St., N.W., Washington 10, D. C.

**CAPITOL RADIO ENGINEERING INSTITUTE**

*ECPD Accredited Technical Institute Curricula—Founded 1927*

Dept. 116-Y 3224 16th St., N.W. Washington 10, D. C.

Please send me your course outline and FREE illustrated booklet "Your Future in the New World of Electronics" . . . describing opportunities and CREI home study courses in Practical Electronic Engineering Technology.

- CHECK FIELD OF GREATEST INTEREST
- Radar, Servo and Computer Engineering Technology
  - Electronic Engineering Technology
  - Broadcast (AM, FM, TV) Engineering Technology
  - Television Engineering Technology
  - Aeronautical Electronic Engineering Technology

Name \_\_\_\_\_ Age \_\_\_\_\_

Street \_\_\_\_\_

City \_\_\_\_\_ Zone \_\_\_\_\_ State \_\_\_\_\_

Check:  Home Study  Residence School  Korean Veteran

**NOT FOR BEGINNERS**

If you have had a high school education, and experience in electronics—and realize the need of high-level technical knowledge to make good in the better electronic jobs—you can qualify for CREI home study training. (Electronics experience is not required for admission to CREI Residence School) Please fill in the following information:

EMPLOYED BY \_\_\_\_\_

TYPE OF PRESENT WORK \_\_\_\_\_

EDUCATION: YEARS HIGH SCHOOL \_\_\_\_\_

YEARS COLLEGE \_\_\_\_\_

ELECTRONICS EXPERIENCE \_\_\_\_\_



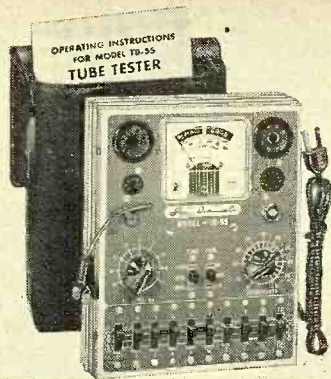

Model TD-55 — TUBE TESTER . . . Total Price \$26.95 — Terms: \$6.95 after 10 day trial, then \$5.00 per month for 4 months.



Model TW-11 — TUBE TESTER . . . Total Price \$47.50 — Terms: \$11.50 after 10 day trial, then \$6.00 per month for 6 months.

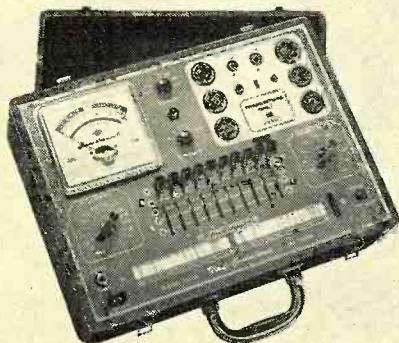

Model TV-12 — TRANSCONDUCTANCE TUBE TESTER . . . Total Price \$72.50 — Terms: \$22.50 after 10 day trial, then \$10.00 per month for 5 months.



Model 770-A — VOLT-OHM-MILLIAMMETER . . . Total Price \$15.85 — Terms: \$3.85 after 10 day trial, then \$4.00 per month for 3 months.

# SHIPPED ON APPROVAL NO MONEY WITH ORDER NO C.O.D.

## Superior's New Model TD-55 EMISSION TYPE TUBE TESTER

For the Experimenter or Part-time Serviceman, who has delayed purchasing a higher priced Tube Tester. For the Professional Serviceman, who needs an extra Tube Tester for outside calls. For the busy TV Service Organization, which needs extra Tube Testers for its field men.

Speedy, yet efficient operation is accomplished by: 1. Simplification of all switching and controls. 2. Elimination of old style sockets used for testing obsolete tubes (26, 27, 57, 59, etc.) and providing sockets and circuits for efficiently testing the new Novol and Sub-Minar types.

**You can't insert a tube in wrong socket**  
It is impossible to insert the tube in the wrong socket when using the new Model TD-55. Separate sockets are used, one for each type of tube base. If the tube fits in the socket it can be tested.

**"Free-point" element switching system**  
The Model TD-55 incorporates a newly designed element selector switch system which reduces the possibility of obsolescence to an absolute minimum.

**Checks for shorts and leakages between all elements**  
The Model TD-55 provides a super sensitive method of

checking for shorts and leakages up to 5 Megohms between any and all of the terminals.

**Elemental switches are numbered in strict accordance with R.M.A. Specifications.**

The 4 position fast-action snap switches are all numbered in exact accordance with the standard R.M.A. numbering system. Thus, if the element terminating in pin No. 7 of a tube is under test, button No. 7 is used for that test.

Complete with carrying case . . . . .

**\$26.95**  
NET

## Superior's New Model TW-11 STANDARD PROFESSIONAL TUBE TESTER

- Tests all tubes, including 4, 5, 6, 7, Octal, Lockin, Hearing Aid, Thyratron, Miniatures, Sub-miniatures, Novols, Sub-minars, Proximity Fuse Types, etc.

- Uses the new self-cleaning Lever Action Switches for individual element testing. All elements are numbered according to pin-number in the RMA base numbering system.

- Model TW-11 does not use combination type sockets. Instead individual sockets are used for each type of tube. Thus it is impossible to damage a tube by inserting it in the wrong socket.

- Free-moving built-in roll chart provides complete data for all tubes. Printed in large easy-to-read type.

**NOISE TEST:** Phono-jack on front panel for plugging in either phones or external amplifier detects microphonic tubes or noise due to faulty elements and loose internal connections.

### EXTRAORDINARY FEATURE

**SEPARATE SCALE FOR LOW-CURRENT TUBES** Previously, on emission-type tube testers, it has been standard practice to use one scale for all tubes. As a result, the calibration for low-current types has been restricted to a small portion of the scale. The extra scale used here greatly simplifies testing of low-current types.

Housed in hand-rubbed oak cabinet . . .

**\$47.50**  
NET

## Superior's New Model TV-12 TRANS-CONDUCTANCE TUBE TESTER

- ★ **Employs improved TRANS-CONDUCTANCE circuit.** An in-phase signal is impressed on the input section of a tube and the resultant plate current change is measured. This provides the most suitable method of simulating the manner in which tubes actually operate in Radio & TV receivers, amplifiers and other circuits. Amplification factor, plate resistance and cathode emission are all correlated in one meter reading.

- ★ **NEW LINE VOLTAGE ADJUSTING SYSTEM.** A tapped transformer makes it possible to compensate for line voltage variations to a tolerance of better than 2%.

- ★ **SAFETY BUTTON**—protects both the tube under test

and the instrument meter against damage due to overload or other form of improper switching.

### EXTRA FEATURE:

**Model TV-12 Also Tests Transistors!**

A transistor can be safely and adequately tested only under dynamic conditions. The Model TV-12 will test all transistors in that approved manner, and quality is read directly on a special "transistor only" meter scale.

Housed in hand-rubbed oak cabinet . . .

**\$72.50**  
NET

## Superior's New Model 770-A POCKET-SIZED VOLT-OHM MILLIAMMETER

USING THE NEW  
"FULL VIEW" METER

71% MORE SCALE AREA

Occupies exactly the same space used by the older standard 2 1/2" Meters, yet provides 71% more scale area. As a result, all calibrations are printed in large easy-to-read type.

• Housed in round-cornered, molded case. Beautiful black etched panel.

6 A.C. VOLTAGE RANGES: 0-15/30/150/300/1500/3000 Volts • 6 D.C. VOLTAGE RANGES: 0-7.5/15/75/150/750/1500 Volts • 2 RESISTANCE RANGES: 0-10,000 Ohms, 0-1 Megohm • 3 D.C. CURRENT RANGES: 0-15/150 Ma., 0-1.5 Amps. • 3 DECIBEL RANGES: -6 db to +18 db, +14 db to +38 db, +34 db to +58 db.

Complete with test leads . . . . .

**\$15.85**  
NET

## USE APPROVAL FORM ON NEXT PAGE

We invite you to try before you buy any of the models described on this and the following page. If after a 10 day trial you are completely satisfied and decide to keep the Tester, you need send us only the down payment and agree to pay the balance due at the monthly indicated rate.

**NO INTEREST OR FINANCE  
CHARGES ADDED!**

If not completely satisfied, you are privileged to return the Tester to us, cancelling any further obligation.



# TRY FOR 10 DAYS

**before** you buy!

**then** if satisfactory pay in easy, interest free, monthly payments. See coupon below.

Superior's New Model 77

## VACUUM TUBE VOLTMETER

WITH NEW 6" FULL-VIEW METER

Compare it to any peak-to-peak V. T. V. M. made by any other manufacturer at any price!

- ✓ Model 77 completely wired and calibrated with accessories (including probe, test leads and portable carrying case) sells for only \$42.50.
- ✓ Model 77 employs a sensitive six inch meter. Extra large meter scale enables us to print all calibrations in large easy-to-read type.
- ✓ Model 77 uses new improved SICO printed circuitry.
- ✓ Model 77 employs a 12AU7 as D.C. amplifier and two 9006's as peak-to-peak voltage rectifiers to assure maximum stability.
- ✓ Model 77 uses a selenium-rectified power supply resulting in less heat and thus reducing possibility of damage or value changes of delicate components.
- ✓ Model 77 meter is virtually burn-out proof. The sensitive 400 microampere meter is isolated from the measuring circuit by a balanced push-pull amplifier.
- ✓ Model 77 uses selected 1% zero temperature coefficient resistors as multipliers. This assures unchanging accurate readings on all ranges.

**AS A DC VOLTMETER:** The Model 77 is indispensable in Hi-Fi Amplifier servicing and a must for Black and White and color TV Receiver servicing where circuit loading cannot be tolerated.

**AS AN AC VOLTMETER:** Measures RMS values if sine wave, and peak-to-peak value if complex wave. Pedestal voltages that determine the "black" level in TV receivers are easily read.

**AS AN ELECTRONIC OHMMETER:** Because of its wide range of measurement leaky capacitors show up glaringly. Because of its sensitivity and low loading, intermittents are easily found, isolated and repaired.

Model 77 comes complete with operating instructions, probe and test leads. Use it on the bench — use it on calls. A streamlined carrying case, included at no extra charge, accommodates the tester, instruction book, probe and leads. Operates on 110-120 volt 60 cycle. Only .....

**\$4250**  
NET



Model 77 — VACUUM TUBE VOLTMETER ... Total Price \$42.50 — Terms: \$12.50 after 10 day trial, then \$6.00 per month for 5 months.

Superior's New Model 76

## ALL PURPOSE BRIDGE

IT'S A CONDENSER BRIDGE IT'S A RESISTANCE BRIDGE IT'S A SIGNAL TRACER IT'S A TV ANTENNA TESTER

Specifications

- ✓ **CAPACITY BRIDGE SECTION**  
4 Ranges: .00001 Microfarad to .005 Microfarad; .001 Microfarad to .5 Microfarad; .1 Microfarad to 50 Microfarads; 20 Microfarads to 1000 Microfarads. Will also measure the power factor of all condensers from .1 to 1000 Microfarads.
- ✓ **RESISTANCE BRIDGE SECTION**  
2 Ranges: 100 ohms to 50,000 ohms; 10,000 ohms to 5 megohms.
- ✓ **SIGNAL TRACER SECTION**  
With the use of the R.F. and A.F. Probes included

with the Model 76, you can make stage gain measurements, locate signal loss in R.F. and Audio stages, localize faulty stages, locate distortion and hum, etc.

- ✓ **TV ANTENNA TESTER SECTION**  
Loss of sync, snow and instability are only a few of the faults which may be due to a break in the antenna, so why not check the TV antenna first? Locates a break in any TV antenna and measures the location of the break in feet from the set terminals. Complete with R.F. and A.F. probes and test leads. ....

**\$2695**  
NET

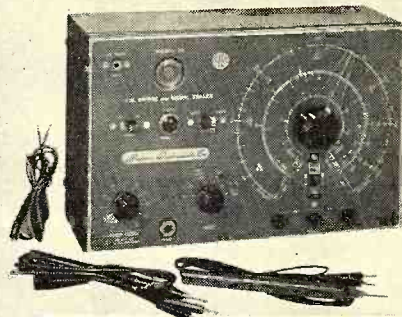

Model 76 — ALL PURPOSE BRIDGE ... Total Price \$26.95 — Terms: \$6.95 after 10 day trial, then \$5.00 per month for 4 months.

Superior's New Model TV-50

## GENOMETER

7 Signal Generators in One!

- ✓ R.F. Signal Generator for A.M.
- ✓ Audio Frequency Generator
- ✓ Color Dot Pattern Generator
- ✓ R.F. Signal Generator for F.M.
- ✓ Bar Generator
- ✓ Marker Generator
- ✓ Cross Hatch Generator

**R.F. SIGNAL GENERATOR:** 100 Kilocycles to 60 Megacycles on fundamentals and from 60 Megacycles to 180 Megacycles on powerful harmonics

**VARIABLE AUDIO FREQUENCY GENERATOR:** Provides a variable 300 cycle to 20,000 cycle peaked wave audio signal.

**BAR GENERATOR:** Pattern consists of 4 to 16 horizontal bars or 7 to 20 vertical bars.

**CROSS HATCH GENERATOR:** The pattern consists of non-shifting horizontal and vertical lines interlaced to provide a stable cross-hatch effect.

**DOT PATTERN GENERATOR (FOR COLOR TV):** The Dot Pattern projected on any color TV Receiver tube by the Model TV-50 will enable you to adjust for proper color convergence.

**MARKER GENERATOR:** The following markers are provided: 189 Kc., 262.5 Kc., 456 Kc., 600 Kc., 1000 Kc., 1400 Kc., 1600 Kc., 2000 Kc., 2500 Kc., 3579 Kc., 4.5 Mc., 5 Mc., 10.7 Mc., (3579 Kc. is the color burst frequency.)

Complete with shielded leads. ....

**\$4750**  
NET

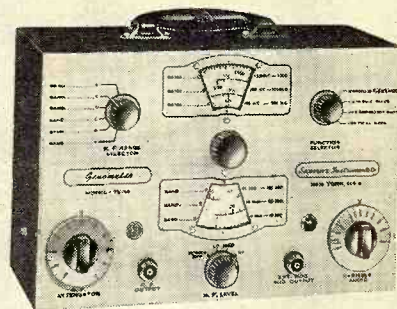

Model TV-50 — GENOMETER ... Total Price \$47.50 — Terms: \$11.50 after 10 day trial, then \$6.00 per month for 6 months.

MOSS ELECTRONIC DISTRIBUTING CO., INC.  
Dept. D-476, 3849 Tenth Ave., New York 34, N. Y.

Please send me the units checked on approval. If completely satisfied I will pay on the terms specified with no interest or finance charges added. Otherwise, I will return after a 10 day trial positively cancelling all further obligation.

Name .....

Address .....

City ..... Zone ..... State .....  
All prices net, F.O.B., N.Y.C.

- Model TD-55 ... Total Price \$26.95 \$6.95 within 10 days. Balance \$5.00 monthly for 4 months.
- Model TW-11 ... Total Price \$47.50 \$11.50 within 10 days. Balance \$6.00 monthly for 6 months.
- Model TV-12 ... Total Price \$72.50 \$22.50 within 10 days. Balance \$10.00 monthly for 5 months.
- Model 770-A ... Total Price \$15.85 \$3.85 within 10 days. Balance \$4.00 monthly for 3 months.
- Model 77 ... Total Price \$42.50 \$12.50 within 10 days. Balance \$6.00 monthly for 5 months.
- Model 76 ... Total Price \$26.95 \$6.95 within 10 days. Balance \$5.00 monthly for 4 months.
- Model TV-50 ... Total Price \$47.50 \$11.50 within 10 days. Balance \$6.00 monthly for 6 months.





**ISAAC STERN**  
**makes his home**  
**recordings on**



**That alone is not**  
**the reason why**  
**you should use**



**Here's why**  
**you should use**



It's the best-engineered tape in the world ... gives you better highs... better lows... better sound all around! Saves your tape recorder, too - because the **irish FERRO-SHEEN** process results in smoother tape ... tape that can't sand down your magnetic heads or shed oxide powder into your machine. Price? Same as ordinary tape!



Available wherever quality tape is sold.  
**ORR** Radio Industries, Inc., Opelika, Alabama  
 Export: **Morhan Exporting Corp.**, New York, N. Y.  
 Canada: **Atlas Radio Corp.**, Ltd., Toronto, Ontario



**IMPORTED RECORDER**  
*GBC America Corp.*, 243 Broadway, New York 7, N. Y. is handling the U.S. distribution of a subminiature tape recorder-dictating machine which is being imported from Italy and marketed as the "Phonetic PT/12."

The unit weighs only 10 pounds and comes complete with microphone, reel of magnetic recording tape, rewind reel, and form-fitting carrying case of leatherette.

The device is controlled by a set of "picture push-buttons" whose simple markings picture all operating func-

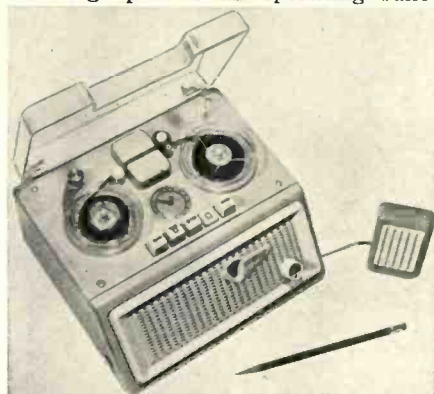

tions; fast rewind, playback, stop, record, and fast forward. Built-in safety locks prevent accidental erasure.

The recorder offers dual-speed, dual-track operation with a choice of either 1½ or 3¼ ips and up to an hour and twenty minutes recording time. The unit takes standard 3-inch reels.

There is a built-in amplifier and speaker system, built-in jacks, a clock-type counter to aid in locating any portion of the tape, and an electronic glow light for use as a volume level indicator. Frequency response is 75 to 7500 cps and power output is 2½ watts.

**REVERB UNIT**

*Ultron Company*, 7943 Haskell Ave., Van Nuys, Calif. is now offering a simple reverberation unit which has been designed to add "presence" to monaural signal sources.

The "U-2" unit is employed as a link between the basic amplifier output and the input of any auxiliary amplifier and speaker combination. Complete instructions for making the hook-up are included with the unit.

**"KLH MODEL SIX"**

*KLH Research and Development Corp.*, 30 Cross St., Cambridge, Mass. is now offering a two-way loudspeaker system, the Model Six.

Housed in a 5-ply wooden "bookshelf" cabinet which measures 23½"

long by 12½" deep, and 12¼" high, the system incorporates a 12" low-frequency speaker and a small cone-type



direct radiator to handle the high frequencies. An LC crossover network, with provision for high-frequency adjustment, is an integral part of the system.

Actual pressure response measurements taken in a free field with a calibrated microphone are: low-frequency speaker response ± 2 db from 45 to 1200 cps; high-frequency speaker response ± 2 db from 1200 to 20,000 cps; and over-all system response of 45 to 20,000 cps ± 2 db.

The Model Six is being offered in a choice of three furniture finishes; mahogany, walnut, and birch.

**STEREO PREAMP KIT**

*Arkay Kits*, 120 Cedar St., New York, N. Y. has announced a stereophonic preamp/control center kit which is said to be the first such unit available in kit form.

The SP-6 features inputs for tape deck, two magnetic cartridges equal-



ized for RIAA to permit playing of either stereo tapes or discs, level controls on the tuner and auxiliary inputs, and switching for parallel operation when the equipment is used for monaural program sources.

The unit is available factory wired or in kit form. Designed for a bookshelf installation, the SP-6 measures 15" x 4" x 9". Further details will be supplied by the manufacturer on request.

**"SONORAMIC" TAPE**

*Ferrodynamics Corp.* of Lodi, N. J. is now marketing a new magnetic tape in its "Sonoramic" line.

The new tape uses *Du Pont* tensilized double-play mylar as a base



which makes it ideally suited for off-the-air recording. It provides enough time to record an entire opera without interruption.

Like the three other tapes in the firm's line, this new product comes on a 7-inch "V-Slot Selection-Finder Reel". The slot facilitates quick threading while selection finder numbers molded along the edges of the slot permit rapid location of the desired selection.

The reel is made of opaque slate gray plastic and matches the perma-

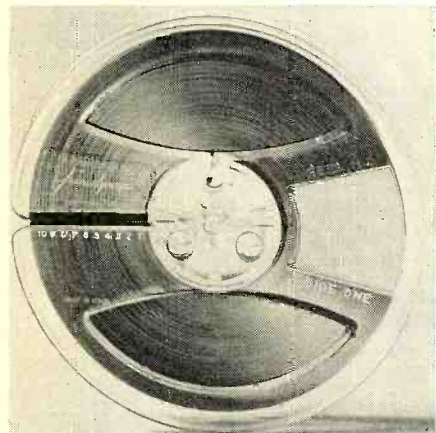

nent plastic container which protects all of the "Sonoramic" tapes. Ample space for selection identification is provided.

#### STEREO CARTRIDGE FROM ERIE

The Electronics Division of *Erie Resistor Corporation*, Erie, Pa. has announced the development of a stereo phonograph cartridge with a single ceramic element.

The new unit will be made available to original equipment manufacturers and the replacement market. Frequency range is 50 to 15,000 cps  $\pm$  5 db into a 3-megohm load while typical channel separation is 20 db. Output voltage at 1 kc. is .5 volt minimum. A tone arm pressure of 3 to 8 grams is the recommended tracking force.

The "Ceramelex" stereo cartridge will operate with any standard amplifier and is compatible with monaural records.

#### IMPORTED FM TUNER

*Airex Radio Corp.*, 64 Cortland St., New York 7, N. Y. is handling the U.S. distribution of the "TSL" FM tuner, a British-built unit of unusual sensitivity.

Sensitivity is .9  $\mu$ v. for 20 db quieting and 1.8  $\mu$ v. for 30 db. Frequency



response is  $\pm$  1/2 db from 20 to 20,000 cps. The circuit incorporates six *Mullard* high-gain, low-noise tubes and ten tuned circuits. The front end is completely shielded in a solid casting.

June, 1958

OSCILLOSCOPE COURTESY OF PRECISION APPARATUS COMPANY, INC.

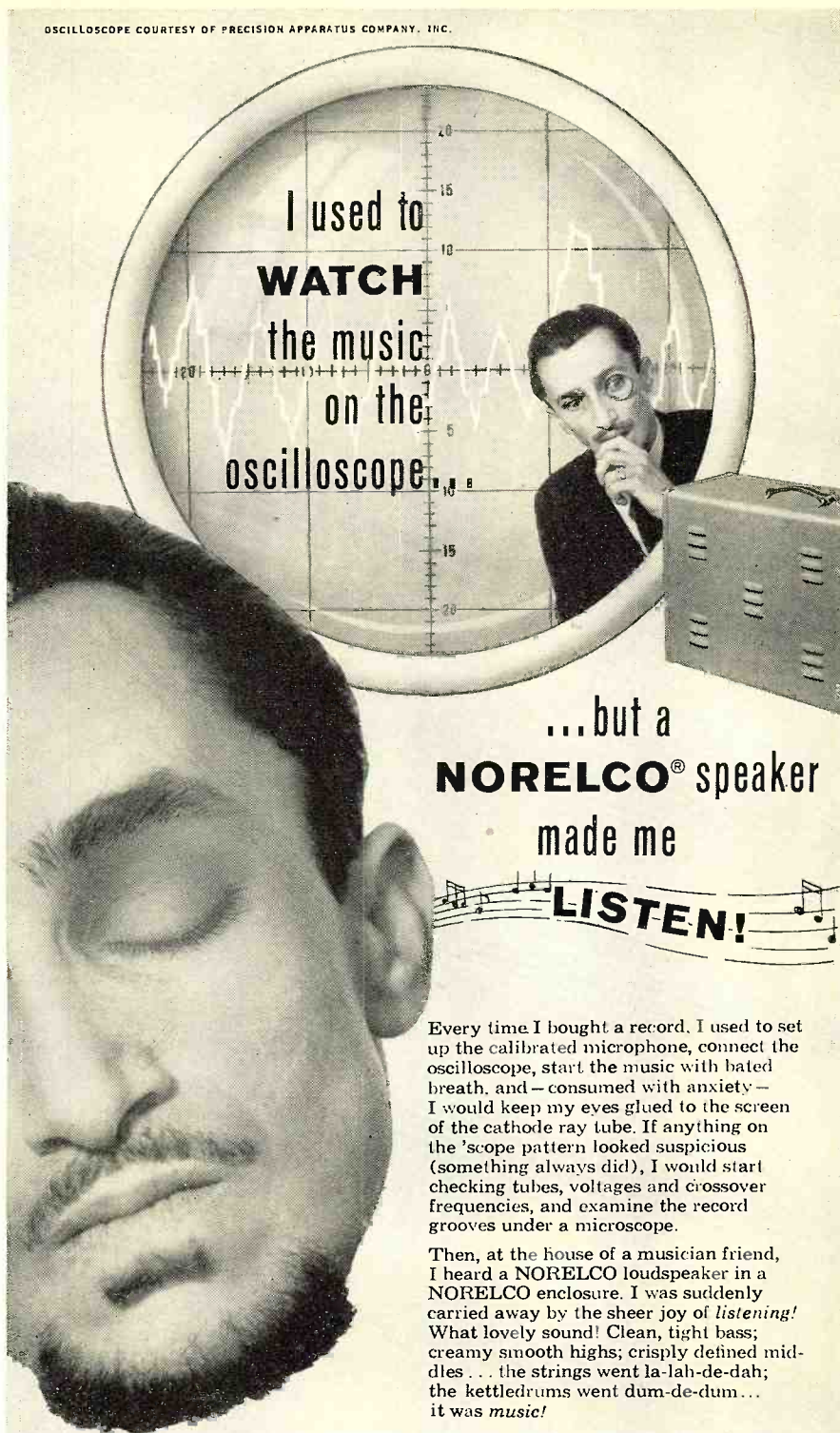

I used to  
**WATCH**  
the music  
on the  
oscilloscope

...but a  
**NORELCO®** speaker  
made me

**LISTEN!**

Every time I bought a record, I used to set up the calibrated microphone, connect the oscilloscope, start the music with bated breath, and — consumed with anxiety — I would keep my eyes glued to the screen of the cathode ray tube. If anything on the 'scope pattern looked suspicious (something always did), I would start checking tubes, voltages and crossover frequencies, and examine the record grooves under a microscope.

Then, at the house of a musician friend, I heard a NORELCO loudspeaker in a NORELCO enclosure. I was suddenly carried away by the sheer joy of *listening!* What lovely sound! Clean, tight bass; creamy smooth highs; crisply defined middles... the strings went la-lah-de-dah; the kettledrums went dum-de-dum... it was *music!*

I rushed out of my friend's house to the nearest hi-fi dealer, bought my own NORELCO speaker, took it right home with me... and I am a different person today. Man, just listen to that *music!*

(You can change your hi-fi life, too — just write to North American Philips Co., Inc., High Fidelity Products Division, 230 Duffy Avenue, Hicksville, Long Island, N. Y.)

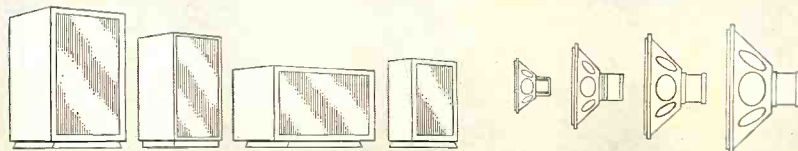

NORELCO offers you a line of 5" to 12" high-fidelity speakers and acoustically engineered enclosures.



**Perma-Power**

# TRANSISTOR POWER SUPPLY

MODEL A-400

**Especially designed to operate, service and test transistor portable radios and low power transistor circuits.**

Highest quality components combined with careful engineering make this instrument extremely reliable and useful for laboratory and service applications.

**\$64.50** from Electronic Parts Distributors only

**"TRULY A VARIABLE BATTERY"**

## SPECIFICATIONS

Input: 115 Volts 50/60 cycles  
 Output Voltage: 0-15 Volts and 0-30 Volts  
 Output Current: 0-15 MA and 0-60 MA  
 Accuracy: 2% on both voltage and current  
 Ripple: Less than 500 microvolts (.002% at full output)  
 Regulation: 1.2 Volts Maximum; Zero to full load current  
 Internal Impedance: Less than 20 ohms DC to Radio Frequencies (including 7.0 ohm Meter Fuse, optionally removable)  
 Terminals: 5-Way Binding Post  
 Size: 10" x 6 1/2" x 5 3/4"  
 Weight: 16 pounds

## FEATURES

- Continuously adjustable output using variable autotransformer control, setting of all transistor battery voltages.
- Two output voltage ranges for accurate setting of all transistor battery voltages.
- Two output current ranges monitor current for single transistor or entire set.
- Extremely low ripple for testing lowest level transistor circuits.
- Very low internal impedance providing excellent regulation.
- Precision D'Arsonval meters provide laboratory accuracy.
- Milliammeter protected by front panel fuse; additional internal line fuse.
- Output isolated from line and case.
- Attractive Slope — Front, Maroon Hammerloid Cabinet — Rubber feet.

**Perma-Power**

Manufactured by **Perma-Power COMPANY** 3100 N. ELSTON AVENUE CHICAGO 18, ILL

There's always something new being developed by Perma-Power

The unit covers the full 88 to 108 mc. band with a 0-100 logging scale. A completely sealed grounded-grid r.f. amplifier and reflex converter eliminate microphonics. There is a "V" beam tuning indicator and an illuminated, unbreakable precision-calibrated dial assembly.

The tuner will operate on 110/125 volts a.c., 50 or 60 cycles. It draws 30 watts and measures 10 1/2" x 5 3/4" x 6 1/2". Further details and prices are available from the distributor.

## MOBILE AMPLIFIER

Allied Radio Corporation, 100 N. Western Ave., Chicago 80, Ill. has just released its new "Knight" KN-3025 25-watt mobile amplifier.

This medium-power public address unit features operation from 6 or 12 volts d.c. or 110 volts a.c. and delivers a full 25 watts of usable audio output.

Designed to provide sound coverage of areas up to 85,000 square feet, the



unit is suitable for carnivals, athletic events, picnics, etc. as well as for mobile advertising, emergency paging, and similar applications. The amplifier is being offered either with or without the built-in, top-mounted record player.

There are inputs for two microphones and two record players and outputs of 4, 8, 16, 250, and 500 ohms as well as an output to match 70.7-volt lines. Frequency response at full 25-watt output is  $\pm 2$  db from 40 to 20,000 cps.

The unit measures 6 1/16" high, 16 1/4" wide, and 10 3/4" deep.

## STEREO CONTROL AND PREAMP

Fisher Radio Corporation, 21-21 Forty-Fourth Drive, Long Island City 1, N. Y. is now marketing an inte-

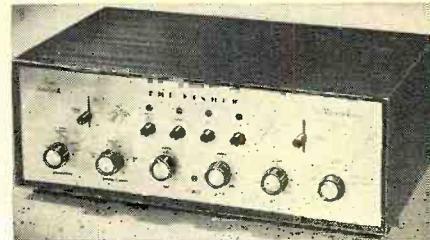

grated stereophonic master audio control and preamplifier which has been designated as the "400."

The stereophonic facilities of the "400" provide for the use of tapes, discs, FM-FM, FM-AM, FM-multiplex, and microphones. Monaural applications extend to tapes, discs, dynamic microphones, AM, FM, TV sound, and

## RCA Sound Tape



... on "Load-Easy" reels for fast tape threading!

Now available wherever superior-quality magnetic tape is sold. On 5" and 7" Load-Easy Reels for fast, simplified threading. Excellent for low-noise, extended-range recording and playback!



**RADIO CORPORATION OF AMERICA**

Electron Tube Division Harrison, N. J.

## Dynaco Output Transformers



Featuring para-coupled windings, a new design principle (patents pending). These transformers use advanced pulse techniques to insure superior square wave performance and undistorted reproduction of transients. Dynaco transformers handle full rated power over the entire audio spectrum from 20 cps to 20 kc, without sharp rise in distortion at the ends of the band which characterizes most transformers. Conservatively rated and guaranteed to handle double nominal power from 30 cps to 15 kc without loss of performance capabilities.

### Specifications:

Response: Plus or minus 1 db 6 cps to 60 kc. Power Curve: Within 1 db 20 cps to 20 kc. Square Wave Response: No ringing or distortion from 20 cps to 20 kc. Permissible Feedback: 30 db

### MODELS

A-410	15 watts	EL-84, 6V6, 6AQ5	14.95
A-420	30 watts	5881, EL-34, KT-66	19.95
A-430	60 watts	KT-88, EL-34	29.95
A-440	120 watts	KT-88, 6550	39.95
A-450	120 watts	PP par KT-88, EL-34	39.95

(all with tapped primaries except A-440 which has tertiary for screen or cathode feedback)

Additional data on Dynakit and Dynaco components available on request including circuit data for modernization of Williamson-type amplifiers to 50 watts of output and other applications of Dynaco transformers.

## DYNACO INC.

617 N. 41st, Philadelphia 4, Pa.  
 Export Division: 25 Warren St., New York, N.Y.



short-wave. Stereo and monaural recording includes built-in monitoring facilities. The unit can also be used as an electronic crossover network to drive a dual-channel amplifier-speaker system.

Sixteen input jacks are arranged in eight pairs while four output jacks are provided on the rear apron. Nine front-panel controls make operation simple and accurate.

Cabinets for the equipment are available at additional cost in blonde, mahogany, or walnut finishes. They measure 15 3/4" x 9 1/16" x 5 5/8".

#### NEW "R-J" ENCLOSURE LINE

R-J Audio Products, Inc., a division of British Industries Corp., 80 Shore Road, Port Washington, N. Y. has announced the availability of five completely restyled models of its patented speaker enclosure.

Currently available are the RJ/8, RJ/12-S, RJ/12-F, RJ/15, and RJ/Supper 8. All of the new enclosures feature triple rigid laminate board of uniform density for the front, rear, and baffle portions plus compact size due to the patented R-J principles.

For full details on specific enclosures in this new line, write the manufacturer direct.

#### TRANSVISION'S "DUAL-AMP"

Transvision, Inc. of New Rochelle, N. Y. has developed a new device which provides the illusion of stereophonic reproduction from monaural records, tape, or FM program sources.

The "Dual-Amp" is essentially an electronic divider which separates the low and high frequency components. The low frequencies are channeled through a section which amplifies and



changes the tonal response as desired and sends these impulses to a low-frequency speaker system. The higher frequencies are similarly treated by the other section of the "Dual-Amp."

Individual controls for altering the frequency response and sound level of each section give the listener a wide latitude in achieving different effects.

For additional information and price, write the manufacturer direct. Letters should be marked to the attention of Mr. Herbert Suesholtz, president of the firm.

#### ESL STEREO CARTRIDGE

Electro-Sonic Laboratories, Inc., 35-54 36th St., Long Island City 6, N. Y. is on the market with an electrodynamic stereo cartridge for reproduction of the Westrex 45-45 stereo discs.

## terado Trav-Electric MOBILE POWER CONVERTERS



Give You  
**110 A.C. HOUSE  
CURRENT  
ANYWHERE**  
You Drive or Cruise

LIST

For 6 and 12 Volt  
Car Batteries —  
Capacities: 1.5 to  
200 Watts

**\$12.95**  
UP

#### NO INSTALLATION

Just plug into cigar lighter  
on dash of car, truck, or  
boat—and away we go

- OPERATE PORTABLE TV
  - SMALL DO-IT-YOURSELF
  - TOOLS WHEREVER NEEDED
- One of the great conveniences of our electronic age

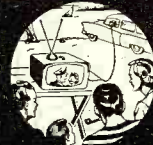

PORTABLE TV



DICTIONARY

**101  
USES**



ALL-ELECTRIC  
SHAVERS



DO-IT-YOURSELF  
HOBBY TOOLS

terado **COMPANY**  
See Your Electronic Parts Dealer or Jobber

DESIGNERS & MFRS. OF ELECTRONIC EQUIPMENT SINCE 1927  
1038 RAYMOND AVE., ST. PAUL 14, MINNESOTA  
CANADA: ATLAS RADIO CORP. ATION LTD. ONTARIO

# Famous G-E VR

A dramatic cartridge design to bring you greater heights in Hi-Fi performance

**New Full-range Reproduction.** General Electric's VR II magnetic cartridge makes possible faithful reproduction in the frequency range from 20 through 20,000 cycles.

**New 4-Gram Tracking Force.** Lateral compliance of the VR II has been extended to 1.7 x 10<sup>-6</sup> cm per dyne, permitting a tracking force of only 4 grams to minimize record and stylus wear.

**Instant CLIP-IN-TIP Stylus.** Stylus replacements can be made at home without removing cartridge from tone arm. No need to discard an entire assembly when only one tip is worn.

**New Electrostatic Shielding.** Prevents pick-up of electrostatic interferences and hum; also grounds

stylus assembly, preventing build-up of electrostatic charges from the record surface.

**New Lightweight Construction.** Microscopic precision and strong, lightweight construction of General Electric's new VR II assure your continued pleasure and satisfaction.

Hear the difference! Ask for a demonstration at your dealer's.

\*Manufacturer's suggested selling price

As low as  
**\$9.95\***



For further information write to:  
Specialty Electronic Components Dept.  
Section HFTVN658  
West Genesee Street, Auburn, New York

In Canada:  
Canadian General Electric Company  
189 Dufferin Street, Toronto 3, Canada



GENERAL  ELECTRIC



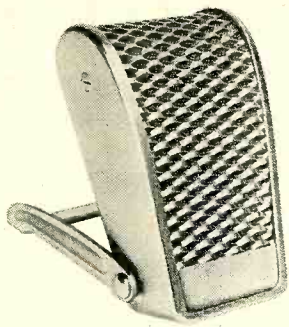

## NEW SUPER-CARDIOID ...and super value!

Difficult acoustic conditions are child's play for this sensational new super-cardioid microphone. Background noise, undesirable echo, and other unwanted sounds disappear when the ESL-SC403 is used for high fidelity broadcasting or recording of music and speech.

Excellent performance, inconspicuous size, and inexpensive price make this advanced moving coil microphone additionally suitable for lecture halls, churches, and conventions. A high impedance model is designated the ESL-SC403H. Write for details on other new ESL microphones.

ESL-SC403    ESL-SC403H  
 FREQUENCY RESPONSE: 50 to 12,000 cps  $\pm 3$  db  
 DIRECTIONAL CHARACTERISTIC: super cardioid  
 INTERNAL IMPEDANCE: 200 ohms    45,000 ohms  
 OUTPUT LEVEL: -50 db    2.2 mv/ $\mu$ bar  
 REFERENCE LEVEL: 1 mw/10 dynes/cm<sup>2</sup>  
 DIMENSIONS: 2" x 1 1/2" x 3 3/4"  
 NET PRICE: \$25.50    \$28



FOR LISTENING AT ITS BEST  
**Electro-Sonic Laboratories, Inc.**  
 Dept. R • 35-54 Thirty-sixth Street • Long Island City 6, N.Y.

### A BOX IS NOT A MUSICAL INSTRUMENT

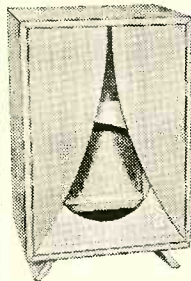

No skilled musical instrument maker, including even those in aboriginal tribes, has ever found a rectangular box satisfactory. **IN SPITE OF THIS,** today many HI-FI speaker systems proclaim the ultimate in high fidelity, yet they employ nothing more than the most elementary boxes to perform the complicated function of transforming the vibrations of the loudspeaker into sound.

In the **KARLSON PATENTED\* ENCLOSURES,** specially curved internal and external structures are used to provide you with the highest performance capabilities available in the industry today. Actually the Karlson enclosure is one of the most fabulous musical instruments ever created and is capable of reproducing every sound from a baby's breath to the mighty roar of thunder. After long and rigorous tests, we know definitely that the Karlson Enclosures can outperform all other units now available on the market at any price.

Despite their fantastic performance characteristics these units are available to you in 20 different models in **KIT, UNFINISHED AND FINISHED FORMS,** at prices you can afford, ranging from \$18.60 to \$174.00.

\*Pat. No. 2,816,619

**SEND FOR OUR COMPLETE CATALOG TODAY AND LEARN HOW THE KARLSON ENCLOSURE CAN BE FITTED TO YOUR SPECIFIC NEEDS.**

**KARLSON ASSOCIATES, INC., Dept RTNB**  
 1610 Neck Road  
 Brooklyn 29, New York

Please send catalog:

Name .....

Address .....

City ..... State .....

### TAPES YOU CAN TRUST!

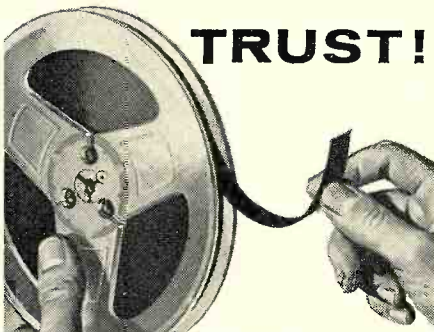

Enjoy  
 professional quality  
 at  
 popular price!



### Magnetic Tape

THE TERM "SCOTCH" IS A REGISTERED TRADEMARK OF 3M CO., ST. PAUL 6, MINN. EXPORT 99 PARK AVE., N.Y. CANADA: LONDON, ONT. ©3M CO., 1958.

MINNESOTA MINING AND MANUFACTURING COMPANY  
 ... WHERE RESEARCH IS THE KEY TO TOMORROW

The heart of the cartridge is a pair of the firm's patented d'Arsonval movements, similar to the single movement used in the C-60 Series

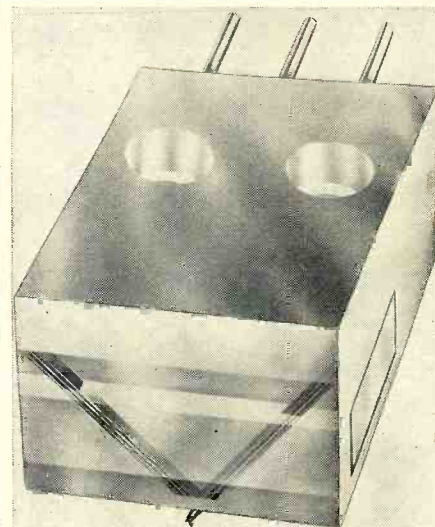

monaural cartridge. These two rotating coils form a "V" shape, with apex at the specially designed stylus shoe.

Range of this cartridge extends from 20 to beyond 18,000 cps, with excellent transient response, according to the company. The output impedance is 20 ohms at 1 kc. and the crosstalk ratio has been reduced to 20 db. Radius of the stylus is .7 mil. This cartridge is designed to fit all standard arms.

### AUDIO CATALOGUES COLORFUL G-E BROCHURES

The Specialty Electronic Components Dept. of *General Electric Company*, Auburn, N. Y. has issued two colorful brochures covering its line of hi-fi components.

The first brochure, EP-257, is printed in three colors and contains brief descriptions of all of the company's components with suggestions for home applications. The second publication, EP-243, is in full color. It is a 12-page booklet covering the listening advantages and record-protecting features of the *G-E* diamond stylus. Specifications on Variable Reluctance II cartridges and clip-in-tip replacement styli are presented in tabular form for quick reference.

Copies of either or both of these brochures are available from the department.

### "INSIDE HIGH FIDELITY"

*Sylvania Home Electronics*, a division of *Sylvania Electric Products Inc.*, Batavia, N. Y. has published a 16-page booklet, "Inside High Fidelity," which is being distributed to dealers to pass on to their customers without charge.

Although the booklet was written by an engineer, it explains in "plain talk" how consumers can get the most out of hi-fi. It answers questions on amplifiers, speaker systems, tuners, sound control, and packaged instruments. The company is supplying this publication without charge.



TV TUBES  
RADIO  
WHAT A BUY  
DYNAMIC  
New  
HIGH FIDELITY FOR  
LESS

# Sales Aids

### CBS PROMOTION

An indoor clock sign, a flange sign, an outdoor sign, and an electric clock designed for the independent service technician have been announced by CBS-Hytron. Each promotional piece



is finished in three colors and advertises the dealer's radio and television service.

The clock sign features interchangeable type for the dealer to spell out his company name or sales messages. The large outdoor sign highlights the dealer's name on both sides while the double-faced flange sign can be used indoors or outdoors. The independent service clock triples as a display, clock, and night light.

These four new signs and clocks are available through the firm's tube distributors. They are illustrated and described in catalogue PA-37 obtainable from the company, Advertising Service Dept., Parker St., Newburyport, Mass.

### AUTO RADIO PROMOTION

A new and unique piece of promotional material has been made available by Vis-U-All Company, 303 Fuller Ave., N. E., Grand Rapids 3, Michigan. Designed for use with the company's

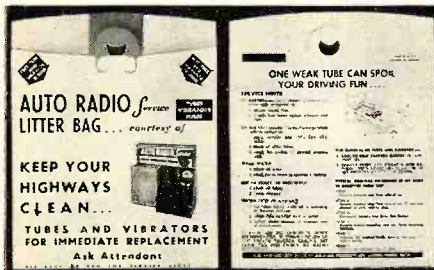

Model V101 auto radio service merchandiser, the unit is called a "Litterbag" and ties in with the national effort to keep the streets and highways free from litter.

The attractively imprinted, two-color piece provides simple hints on auto radio servicing and a space for the service station stamp.

This promotional piece provides a positive means of drawing the motorist's attention to the new, convenient auto radio service available to him.

Further information and prices on the "Litterbag" are available from the company upon request.

# Just 2 settings on the NEW

## Model FC-2 FAST-CHECK TUBE TESTER

tests over 600  
tube types  
completely,  
accurately  
... AND IN  
SECONDS!

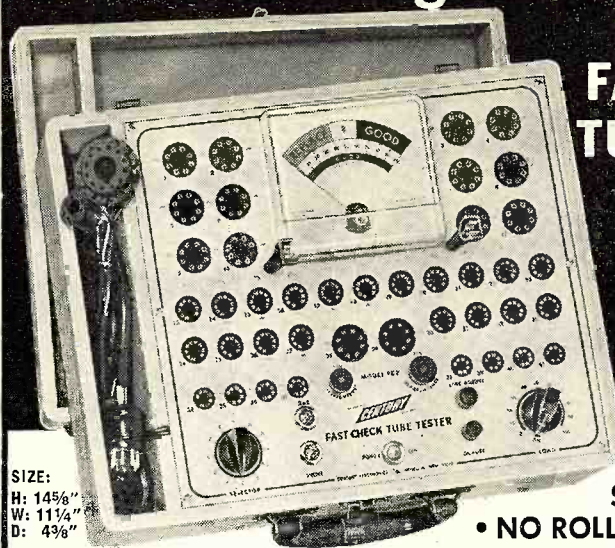

SIZE:  
H: 14 5/8"  
W: 11 1/4"  
D: 4 3/8"

**NEW** Special compartment to accommodate line cord and CRT Test Adapter cable

**CANNOT BECOME OBSOLETE**

Engineered to accommodate all future tube types... new tube listings furnished periodically.

**TRY THE FC-2 BEFORE YOU BUY IT!**

Shipped on approval for FREE 10 day trial... No obligation to buy

**EASY TO BUY IF YOU'RE SATISFIED!**

Pay in small monthly payments at net cash prices... no financing charges

MODEL FC-2—housed in rugged oak carrying case complete with CRT adapter, tube listings... only **\$69.50** Net

**GUARANTEED FOR 1 FULL YEAR**

This extremely low price is made possible only because YOU ARE BUYING DIRECT FROM THE MANUFACTURER

• NO MULTIPLE SWITCHING  
• NO ROLL CHART CHECKING

The FAST-CHECK enables you to save valuable time and eliminate unprofitable call backs. You earn extra money and win confidence by showing your customer the actual condition and life expectancy of the tube on the large meter scale of the FC-2. The extra tubes you will sell each day will pay for the FAST-CHECK in a very short time.

### WIDE RANGE OF OPERATION

- Checks quality of over 600 tube types... more than 99% of all TV and radio tubes, including the newest series-string TV tubes, auto 12 plate-volt tubes, OZ4s, magic eye tubes and gas regulators.
- Checks inter-element shorts and leakage.
- Checks for gas content.
- Checks for life expectancy.

### IMPORTANT FEATURES

- ✓ Checks each section of multi-section tubes and even if only one section is defective the tube will read "Bad"
- ✓ 41 long lasting phosphor-bronze tube sockets accommodate all present and future tube types—cannot become obsolete
- ✓ Less than 10 seconds required to test any tube
- ✓ Large D'Arsonval type meter is extremely sensitive yet rugged—is fully protected against accidental burn-out
- ✓ Line isolated
- ✓ 7-pin and 9-pin straighteners conveniently mounted on panel
- ✓ Quick reference tube chart lists over 600 tube types
- ✓ Line voltage compensation

**NEW** A specially designed PICTURE TUBE ADAPTER cable is now part of the FC-2... making it a highly efficient CRT Tester-Rejuvenator. This feature eliminates the need of carrying extra instruments and makes the FC-2 truly an all-around tube tester. The adapter enables you to check all picture tubes (including the new short-neck 110 degree picture tubes) for cathode emission, shorts and life expectancy... also to rejuvenate and restore cathode emission of weak picture tubes.

"You've really made tube testing a snap"... "I've almost got the cost of the Fast-Check paid off with the extra money I've made, and it's only 2 weeks since I received it"... "It's easier to use than you said"... "I wouldn't ever want to be without it"... "I use it in the shop and take it along on every call!"

WHAT SERVICEMEN\* are SAYING ABOUT THE FC-2

\*Names on request

**MAIL COUPON NOW—NO MONEY REQUIRED WITH ORDER**

**CENTURY ELECTRONICS CO., INC.** 111 Roosevelt Avenue Dept. 206, Mineola, N.Y.

Please rush the new Model FC-2 FAST-CHECK TUBE TESTER for a 10 day trial period. If I am not completely satisfied I will return the instrument within 10 days without further obligation. If fully satisfied I agree to pay the down payment within 10 days and the monthly installments as shown. No financing charges are to be added. Should I fail to make payment when due, the unpaid balance shall become due and payable at once.

- BUDGET TERMS: Pay \$14.50 within 10 days after receipt of instrument. Balance \$11.00 monthly for 5 months, plus shipping charges.
- PREPAID TERMS: Enclose \$69.50 with coupon as payment in full and Century will pay all shipping costs. 10 day money-back guarantee.

Name.....  
Address.....  
City..... State.....

**ABSOLUTELY NO RISK ON YOUR PART**



# All leopards have spots

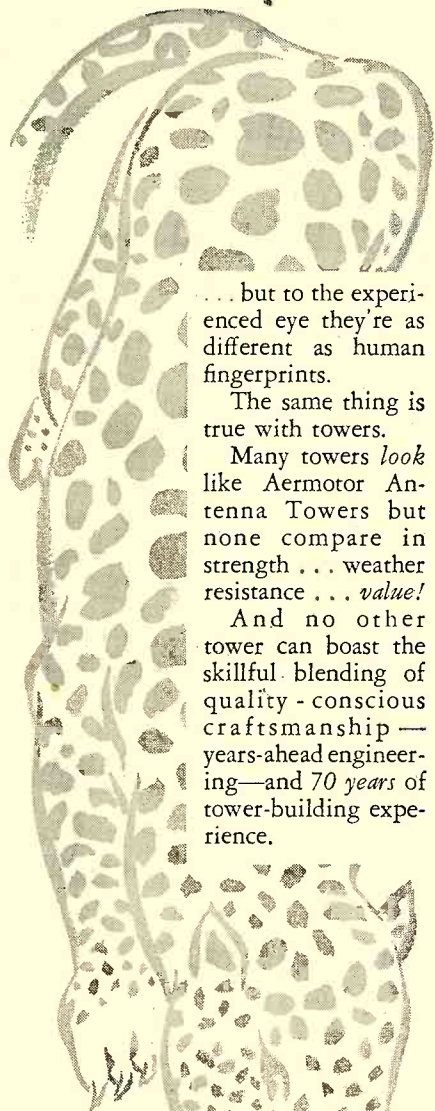

... but to the experienced eye they're as different as human fingerprints.

The same thing is true with towers.

Many towers look like Aermotor Antenna Towers but none compare in strength... weather resistance... value!

And no other tower can boast the skillful blending of quality-conscious craftsmanship—years-ahead engineering—and 70 years of tower-building experience.



ANTENNA TOWER

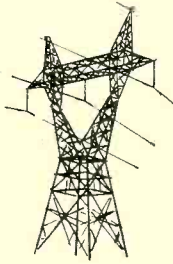

ELECTRIC TRANSMISSION TOWERS



RADIO TOWERS

Write for complete description of Aermotor Self-Supporting Antenna Towers. Ask for folder No. 262-2.

60

## AERMOTOR COMPANY

2500 W. Roosevelt Rd., Chicago 8, Ill. Dept. RT-6

# New Tube Tester Data

These listings keep three Sylvania tube testers in step with the continuing flow of new types.

## SYLVANIA MODEL 620

TYPE	A	B	C	D	E	F	G	K
1G3	1.25	2	13578	24	7	T	0	..
3CY5	5.0A*	3	47	66	4	16RU	5	2
	5.0A*	3	24	66	4	16RU	5	7
4AU6	5.0A*	3	4	24	4	16X	5	7
4DT6	5.0A*	3	4R	46	4	16S	5	2
6AN6	6.3	1	7	37	7	S	2	6
	6.3	1	7	37	7	S	3	6
	6.3	1	7	37	7	S	4	6
	6.3	1	7	37	7	S	5	6
6BK4	6.3	2	367	47	7	05TZ	0	1
6CY5	6.3	3	47	65	4	16RU	5	2
	6.3	3	24	65	4	16RU	5	7
8CN7	7.5A*	4	359R	42	5	7S	8	6
	5.0	4	569	35	9	S	1	2
	7.5A*	4	569	35	5	S	2	3
8SN7GTB	12.6A*	7	68	39	8	1U	2	3
	12.6A*	7	38	39	8	4U	5	6
12CS7	12.6	4	59R	34	5	7X	6	8
	12.6	4	58R	29	5	3Y	1	9
12CN5	12.6	3	45	9	4	26RT	7	1
	12.6	3	24	9	4	56RT	7	1
12DW8	12.6	4	58	37	5	2S	1	3
	12.6	4	35	37	5	7S	6	8
	12.6	4	35	38	5	S	9	8
12EL6	12.6	3	4	48	4	1U	2	7
	12.6	3	4	41	4	S	5	7
	12.6	3	4	41	4	S	6	7
12U7	12.6	4	589R	38	5	2S	0	3
	12.6	4	359R	38	5	7S	6	8
	6.3	9	359R	38	5	7S	6	8
17BY7	19.0	4	569R	28	5	28Y	7	1
	12.6	4	569R	29	6	28Y	7	1
25CA5	25A**	3	45	15	4	26Y	7	1
	25A**	3	24	15	4	56Y	7	1
25AV5GT/GA	25A**	2	7	29	7	18RY	5	3

## SYLVANIA MODELS 219 AND 220

TYPE	A	B	C	D	E	F	G	K
1G3	1.25	2	13578	26	7	U	9	..
3CY5	3.3	3	47	60	4	16SV	5	2
	3.3	3	24	60	4	16SV	5	7
4AU6	5.0	3	4	23	4	16Y	5	7
4DT6	5.0	3	4S	41	4	16T	5	2
6AN6	6.3	1	7	35	7	T	2*	6
	6.3	1	7	35	7	T	3*	6
	6.3	1	7	35	7	T	4*	6
	6.3	1	7	35	7	T	5*	6
6BK4	6.3	2	367	37	7	T	5	1
6CY5	6.3	3	47	65	4	16SV	5	2
	6.3	3	24	65	4	16SV	5	7
8CN7	7.5	4	359S	40	5	7T	8	6
	7.5	4	569	34	5	T	1*	3
	7.5	4	569	34	5	T	2*	3
8SN7GTB	7.5	7	68	38	8	1V	2	3
	7.5	7	38	39	8	4V	5	6
12CN5	12.6	3	45	8	4	26SU	7	1
	12.6	3	24	8	4	56SU	7	1
12DW8	12.6	4	58	34	5	2T	1	3
	12.6	4	35	34	5	7T	6	8
	12.6	4	35	34	5	T	9	8
12CS7	12.6	4	59S	34	5	7Y	6	8
	12.6	4	58S	29	5	3Z	1	9
12EL6	12.6	3	4	48	4	1V	2	7
	12.6	3	4	41	4	T	5	7
	12.6	3	4	41	4	T	6	7
12U7	12.6	4	589S	36	5	2T	1	3
	12.6	4	359S	36	5	7T	6	8
	6.3	9	359S	36	5	7T	6	8
17BY7	19	4	569S	27	5	28Z	7	1
	12.6	4	569S	27	6	28Z	7	1
25AV5GT/GA	25	2	7	29	7	18SZ	5	3
25CA5	25	3	45	19	4	26Z	7	1
	25	3	24	19	4	56Z	7	1



# NEW 1959 MODEL HIGH-FIDELITY SPEAKER SYSTEM ON BAFFLE BOARD \$29.95



**FEATURES 15 INCH MAGNAVOX WOOFER  
12 INCH MID-RANGE MATCHED TWEETERS**

Model VOX-1512, high fidelity 25 watt, 4-way speaker system. Factory manufactured on a baffle board 16" x 32". The speakers featured in this system have been laboratory matched to work as a team to bring you the widest audio response and the nearest to natural listening as possible. Our speakers are packed out this system with its own connectors. Then the finished speaker system was tried and approved by side-by-side comparison with speaker systems selling for \$200.00. We think that its the most value that we have ever offered for the money. Ideal for use with any good audio system. (Impedance 4 ohms). Or, buy a matched pair for your Stereo Hi-Fi system. Mount them in any enclosure or use them just as they come. Features a Magnavox Alnico V 15" PM woofer, 12" Magnavox mid-range, 5" cone tweeter and 4 1/4" deep horn type cone tweeter. Speakers are matched; connected together with capacity-resistance to make each speaker do its share. Stock No. VOX-1512, 4-way speaker system. Sale price, \$29.95, 2 for \$57.95. Choice of blond or mahogany plastic grill cloth for above, \$1.25 extra. Response 20 to 22,500 C.P.S.

## NEW 1959 HI-FI SPEAKER IN ENCLOSURE

New, 1959 model 4-way speaker system is a fully enclosed baffle 37" high, 27" wide and 23 1/2" front to back. Tone equal to high priced nationally advertised systems. Incorporates the same speakers as offered in the VOX-1512 system at left. 25 watts, response 20 to 22,500 cps. Impedance 8 ohms. Equipped with plastic grill cloth. Illustrated with grill cloth removed to show speakers. Model McVOX-151254, Mahogany finish, \$49.95. Model McVOX-15122, Blond finish, \$54.95.

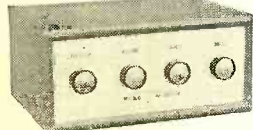
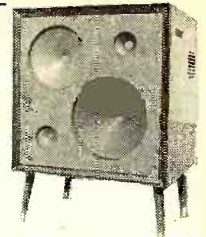

## 16 Watts \$34.95 Factory Wired Hi-Fi Amp

Combination offers: SL-20 and B-125X speaker board \$51.95. SL-20 and VOX-1512, 4-way speaker board, \$61.90. SL-20 and McVOX-151254 speaker system, \$79.95.

New, 1958 model Imperial Slim-Line 16 watt high fidelity amplifier (20 watts peak), with built-in pre-amplifier. Full range audio response from 15 to 22,000 cps. Dual tone controls; full 18 db bass and full 15 db treble boost. Input for radio tuner, tape recorder and phono. Input compensation for the new 1958 model 4 gram General Electric and phono. Electric variable reluctance cartridges, as well as the famous G.E. RPX-050, RPX-052 and crystal phono cartridges. 5 position selector switch selects inputs and record compensation. Compensation for AES and RIAA phono records. A factory built amplifier at less than kit price. Features tone matches 8 or 16 ohm high fidelity PM multi-color leatherette covered wood cabinet at no added cost; matches blond or mahogany finish speaker systems. Size: 5 1/2" tall, 11 1/4" wide, 8" front to back. Ship. wt. 15 lbs. Model SL-20 Imperial, List price, \$69.50. McGee's Sale price, \$34.95.

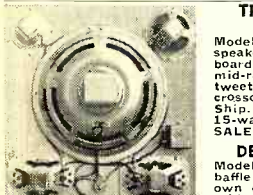

## TREMENDOUS MCGEE VALUE—NEW 1958 HI-FI SPEAKER SYSTEMS ON BAFFLE BOARDS

Model B-125X, high fidelity 15-watt, 5-way speaker system, mounted on 18" square baffle board. Has 12" High Efficiency woofer, 2-4x6" mid-range speakers, plus a 4" high-range and 2" tweeter, all with Alnico V magnets. Built-in crossover network with variable brilliance control. Ship. wt. 11 lbs. Stock No. B-125X, 5-way, 15-watt Hi-Fi speaker system. AUDIOPHILE VALUE \$30.00. SALE PRICE \$18.95.

**DELUXE HI-FI 25 WATT SPEAKER BOARD \$29.95**  
Model B-250X, 4 matched Hi-Fi PM speakers mounted on a baffle board, 18" wide and 30" tall. For installation in your own cabinet or play as it comes. Features 15" woofer, 10" tweeter, all with Alnico V magnets. Built-in crossover network. System is wired ready to connect the two leads to any 8 ohm amplifier or FM-AM radio. 25 watts capacity, from 18 to 17,500 cps. AB matched for finest audio reproduction. \$50.00 list value. McGee's sale price, \$29.95.



## World Famous Imported from Holland NORELCO HI-FI PM SPEAKERS

12" Model 9762-M reg. \$59.97 Sale Price \$39.95  
12" Model 9760 reg. \$32.97 Sale Price \$19.95  
8" Model 9750 reg. \$22.17 Sale Price \$15.95  
NORELCO Model 9762-12" wide range Hi-Fi PM speaker, reg. 35 or less than kit price. Voice coil imp. 8 ohms—new Alnico V magnet gives 11,000 gauss. Regular \$59.97 net, on sale at McGEE for only \$39.95.  
NORELCO Model 9760-12" wide range Hi-Fi PM speaker, reg. 35 or less than kit price. Voice coil imp. 8 ohms—new Alnico V magnet gives 8,000 gauss. Regular \$32.97 net, on sale at McGEE for only \$19.95.  
NORELCO Model 9750-8" wide range Hi-Fi PM speaker, reg. 50 or less than kit price. Voice coil imp. 8 ohms—new Alnico V magnet gives 13,500 gauss. Regular \$22.17 net, on sale at McGEE for only \$15.95; or 2 for \$30.00.

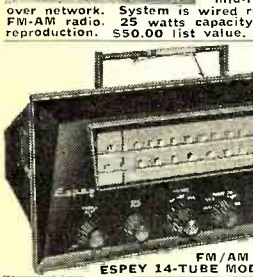

## 22 TUBE ESPEY FM-AM TUNER-AMPLIFIER SALE \$99.95

Espey Model 700G-50IG, complete 14 tube FM-AM tuner and matching 8 tube, 24 watt ultra-linear amplifier. A regular \$199.50 value on sale at McGee for \$99.95. Features AFC on FM. Receives broadcast 550 to 1700 kc and FM, 89 to 108 mc. Built-in preamplifier. Separate bass and treble controls, record equalization. Response, 10 cps to 20,000 cps, auxiliary input jacks. Tuner chassis is 14" long, 8 1/2" high, 10" deep. (Leatherette cabinet for tuner only, \$7.95 extra.) Amplifier 12"x8"x5" (push-pull, parallel 6V6 output tubes). Price includes all tubes, knobs and escutcheon plate. Shipping weight 42 lbs. A true McGee value.

Combination offer with Garrard RC-98 changer and 4G-052 G.E. cartridge, \$174.95, no speaker included. Why not order a Norelco or our new B-250X speaker board with your Espey?

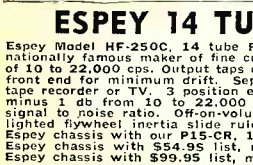

## ESPEY 14 TUBE FM-AM WITH BUILT-IN HI-FI AUDIO \$69.95

Espey Model HF-250C, 14 tube FM-AM chassis with push-pull 6V6, 10 watt amplifier. A true Hi-Fidelity receiver built by a nationally famous maker of fine custom chassis. Ultra-linear output used in Williamson type circuit gives frequency response of 10 to 22,000 cps. Output taps of 4, 8 and 16 ohms. Separate RF stages for FM and AM assure high sensitivity. Temperature compensated FM front end for minimum drift. Separate bass and treble tone controls. Pre-amp for all types of magnetic cartridges. 2nd input for crystal phono, tape recorder or TV. 3 position selector for accurate reproduction of all records. Built-in antennas for both FM and AM. Response, 10 cps to 22,000 cps. Harmonic distortion less than 1%. Sensitivity: FM, 8 mv for 30 db quieting; AM, 75 mv for 6 db signal to noise ratio. Off-on-volume and equalizer are combined on a concentric control. Has 2 AC outlets on rear of chassis. Beautiful edge lighted flywheel inertia slide rate dial. Size: 7 1/2"x13 1/2"x10" deep. Ship. wt. 24 lbs. (not mailable). Model HF-250C Sale price, \$69.95.



## 24 INCH CUSTOM TELEVISION CHASSIS \$129.95

McGee offers this nationally famous make 24" television chassis with laminized picture tube at a terrific saving. Full power transformer operated with switch type cascade tuner. All regular wiring on printed circuits. Chassis is mounted on a baseboard and shipped with picture tube installed. Area required for chassis: 28" wide, 20" high and 20" front to back. Safety glass size, 23 13/16"x19 3/4". Tuner and controls are mounted on a separate bracket to make it easy to move when installing. Price includes all tubes and 24" 24YF4 aluminumized picture tube. Knobs and knobs and knobs. Good quality audio. 2-8" and 2-5" speakers are furnished, mounted on a baffle board 24"x19 3/4". Stock No. MG75-02, with all tubes and 45 day picture tube warranty. Sale price, \$129.95. Price with one year picture tube warranty, \$133.95. Stock No. MG75-02-HF10, same as MG75-02 except with push-pull 6V6 Hi-Fi amplifier and with 2-12" PM's and 2-5" tweeters on a baffle board, \$149.95 and \$149.95.



## AUTOMATIC CHANGERS AT LOW PRICES

Special prices on VM 3 speed Hi-Fi record changers. Equipped with plug-in heads. Features 4 pole motor records changer. A late model High Fidelity 12" records of the same speed, shuts off after last record has played. Size: 13 1/2" x 13 1/2" x 13 1/2". Ship. wt. 12 lbs. VM-935 and VM-936 are the same changer except the 936 is on a base as illustrated. Price includes 45 RPM spindle. VM-935HF with RPX-050A G.E. VR cartridge, \$29.95. VM-936HF on base with RPX-050A G.E. VR cartridge, \$32.95. 1 mil diamond needle, \$4.95 extra.

Latest 4 speed English imported Monarch record changer. Features a 4 pole motor, 9" turntable with molded rubber record pallet. Balanced tone arm readily accepts most makes of Hi-Fi cartridges. Plays 16 2/3, 33 1/3, 45 and 78 RPM records. Intermites 10" and 12" records of the same speed. Shuts off after last record has played. Compact size, 12 3/4" x 10 1/2" x 10 1/2". Ship. wt. 15 lbs. Large 45 RPM spindle, \$1.88 extra. Choice of blond or mahogany wood mounting base, \$4.50 extra. Offered with several types of cartridges.

UAB-8 with Ronette flip-over Hi-Fi crystal cartridge, \$22.95.  
UAB-8RD with Ronette cartridge as above and extra 1 mil diamond needle, \$29.95.  
UAB-4G050 with latest G.E. VR cartridge, \$29.95, 1 mil diamond needle, \$4.95 extra.

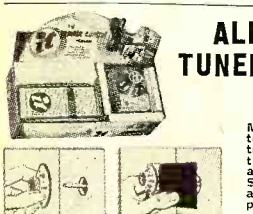

## ALLIANCE "IT" T.V. TUNER REMOTE CONTROL \$4.94

McGee Special Purchase Sale! Alliance "IT" remote tuner for your TV set. A small battery operated motor turns your tuner clockwise or counter-clockwise. Attractive bakelite case fits palm of your hand. Made to sell for \$10.00, but we're offering them for \$4.94, 3 for \$12.50, with flashlight batteries. Also adaptable to many other uses. Add 40c per unit for packing and postage.

# RCA Reg. \$119.50 RADIATION COUNTER ON SALE AT MCGEE for \$29.95

RCA Model WF-10A, Radiation Geiger counter for amateur and professional use. Explore for Uranium or check for atomic fall-out radiation. Complete with test sample. Simple to use, weighs only 5 lbs. In aluminum case. 7 3/4"x8 1/2"x3 1/2". Indicates presence of radioactivity. Complete with meter, neon light and headphones. Requires 2-67 1/2 volt Burgess XX45 "B" batteries and 3-2 flashlight cells. Battery kit, \$5.29 extra. 3 sensitivity ranges, 0-100, 0-1000, and 0-10,000 counts per minute. A terrific value from McGee. RCA Model WF-10A with tubes and headphone, less batteries, \$29.95. Battery kit, \$5.29 extra.

RCA Model WF-12A, Radiation Geiger counter. Similar to WF-10A, except has an external probe. Priced with tubes and headphones at \$34.95, less batteries. Requires 2-XX45 Burgess "B" plus 3-2 flashlight cells, \$5.29 extra.

RCA Model WF-11A, Radiation Geiger counter. Similar to WF-10A, except has an external probe. Priced with tubes and headphones at \$34.95, less batteries. Requires 2-XX45 Burgess "B" plus 3-2 flashlight cells, \$5.29 extra.

RCA Model WF-11A, Radiation Geiger counter. Explore for Uranium or check for atomic fall-out. Uses extra sensitive Bismuth tube. Test sample included. Simple to use, weighs only 5 lbs. Weatherproof case 7 3/4"x8 1/2"x3 1/2". Indicates presence of radioactivity 3 ways, by meter, neon light and headphones. Requires 2 Burgess XX45 "B" batteries and 3-2 flashlight cells. Battery kit \$5.29 extra. 3 sensitivity ranges, 0-200, 0-2000, 0-20,000 counts per minute. A terrific value. RCA WF-11A, Sale price, \$37.95 with tubes and headphone. Battery kit, \$5.29 extra. Similar size to WF-10.

RCA Model WF-15A (not illustrated). Has 10 sensitive tubes, 3 ranges to 100,000 counts per minute. Size, 11"x4 7/8"x7 1/2". Weight 8 lbs. Original price, \$475.00. McGee's Sale price, \$99.50. Battery kit, \$5.37 extra.

RCA Model WF-16A (not illustrated). Has 10 sensitive tubes, 3 ranges to 200,000 counts per minute. Size, 11"x4 7/8"x7 1/2". Weight 8 lbs. Original price, \$750.00. McGee's Sale price, \$149.50. Battery kit, \$5.37 extra.

# McGEE RADIO COMPANY PRICES F.O.B. KANSAS CITY TELEPHONE VICTOR 2-5092

SEND 25% OR FULL REMITTANCE WITH ORDER. (903 MCGEE ST., KANSAS CITY, MISSOURI) BAL. SENT C.O.D.



win a  
dream  
trip  
for  
two



to  
the

# BRUSSELS WORLD'S FAIR!

RK-22

win other exciting prizes...  
in the big, new Rek-O-Kut contest!

Rek-O-Kut's exciting, new contest is a music-lover's delight! You can win a trip for two to the Brussels World's Fair via Sabena Belgian World Airlines... magnificent Rondine turntables... and turntable arms... just by listening to a Rek-O-Kut demonstration. Simply stop in at your high fidelity dealer, ask him to demonstrate high fidelity reproduction on a Rondine turntable, and fill out an entry blank. There are no puzzles to solve — no jingles to write — no coupons to clip — nothing to buy! You'll be eligible for one of the big contest prizes... and you'll have enjoyed music reproduction at its finest — on a Rondine! Prices from \$59.95.

Selected for display at the American Pavilion, Brussels World's Fair!

For the high fidelity dealer nearest you, write:  
**REK-O-KUT COMPANY, INC.**  
38-19 108th Street, Corona 68, New York

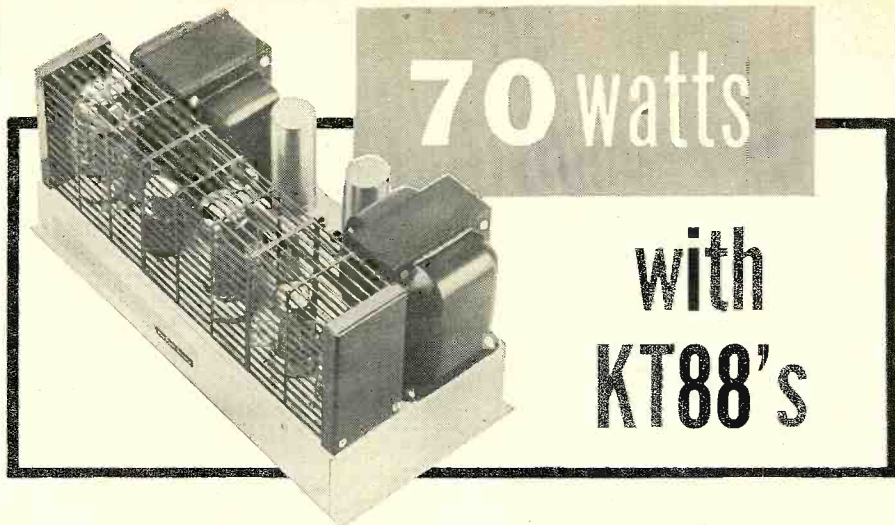

Just loafing along at 70 watts, these KT88's provide dependable and stable hi-fi performance.

ALTHOUGH the greatest interest in power amplifiers today is in the 50- to 70-watt class, the hi-fi enthusiast has been unjustifiably pegged as a "power-boy." The true music lover—the one who really enjoys top performance in quality reproduction—does not blast away even though he uses a high power unit. As is the case with a *Cadillac*, which has the reserve power when required and yet coasts along smoothly when pleasure is of utmost importance, the high power amplifiers today provide exceptional hi-fi reproduction qualities when operating at 2 watts or lower.

One of the newest additions to this

group is *Sargent-Rayment's* "Super Seventy" Model SR-570. Although not too unusual in circuitry, its over-all mechanical and electronic design results in a unit that is well engineered and will provide hours of pleasure for the most critical of hi-fi listeners.

The circuit itself is, in many respects, similar to the British *Mullard* design, originally described in the April, 1956 issue of *RADIO & TV NEWS*. The input stage is an EF86 low-noise voltage amplifier which is direct-coupled to a 6SN7GTB cathode-coupled phase inverter which, in turn, drives the two KT88's in push-pull to their maximum 70-watt output. In

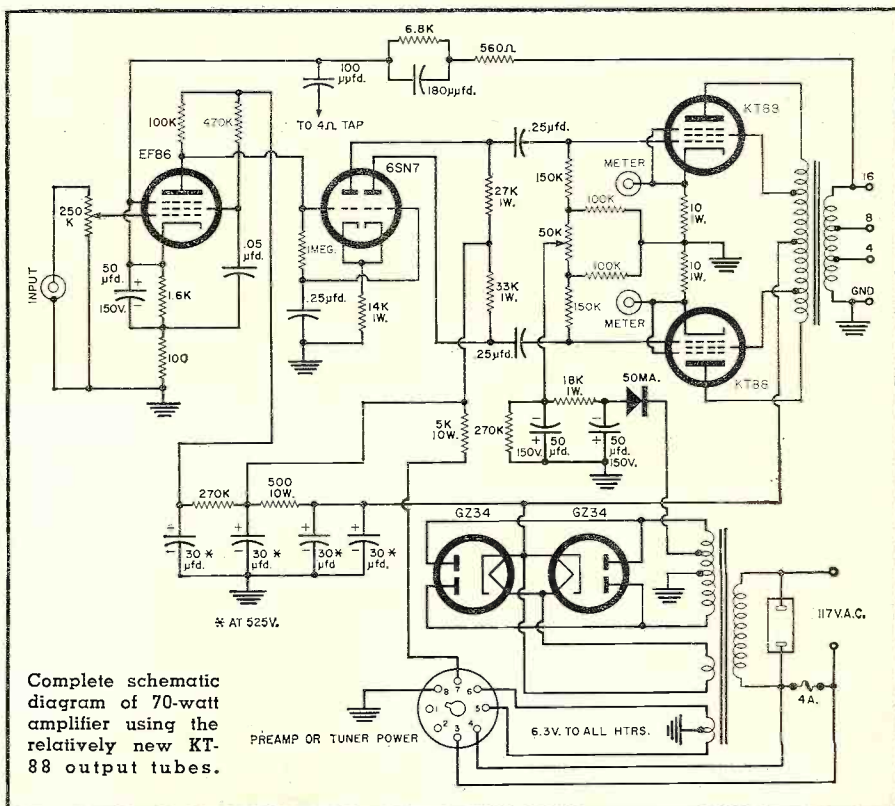

Complete schematic diagram of 70-watt amplifier using the relatively new KT-88 output tubes.



order to provide good stability and regulation, two GZ34 rectifier tubes are used in parallel. Of special interest is the fact that the cathode-coupled phase inverter can be identified as the "long-tailed pair" which was described in the May, 1957 issue of this magazine.

In addition to the normal or conventional fused input circuit and a 250,000-ohm input gain control, provision is made for supplying both filament and "B+" voltages to operate any standard preamplifier.

The manufacturer, keeping in mind problems of balancing output tubes, has provided two tip jacks on top of the amplifier chassis for such balancing when it is required. Output terminals for 4-, 8-, and 16-ohm speaker systems are provided.

As is our normal practice, this unit was measured in our own laboratory since we feel that a complete and unbiased technical report provides much more information than simple listening tests alone. The measured results were as follows:

For maximum power output an input voltage of .48 volt is required.

Hum and noise is -67 db with open input circuit and -69 db with shorted input (referred to 2-watts output).

Frequency response at 2 watts is  $\pm 1$  db from 6 to 54,000 cps. For maximum power output  $\pm 1$  db, response is from 14 to 27,000 cps.

IM distortion at 2-watts equivalent sine-wave output at 60 and 6000 cps (4 to 1 ratio) is .27%. At maximum output of 70 watts the intermodulation distortion under the same conditions is .4%. The 1% figure, which we consider the maximum desirable, occurs at an output of 75 watts.

The harmonic distortion for 2-watts output at 20 cps is .18%; 1000 cps, .08%; and at 20,000 cps, .22%.

Tests were made at the 2% harmonic distortion points since we consider this amount of distortion to be the maximum amount desirable. Such distortion occurs at 54 watts for 20,000 cps and 59 watts for 20 cps. These last two harmonic distortion figures are certainly not unusual. Many manufacturers, when rating their units, specify harmonic distortion at 1 db below maximum power output. At the -1 db point (it is 56 watts in this amplifier) the figures as we measured them come quite close.

According to the manufacturer, this power amplifier does not show any visible overshoot or rounding at any frequency in the audible range between 20 and 15,000 cps.

One point of considerable interest to the user of such equipment is the fact that the over-all design of this power amplifier is on the conservative side. All components are sufficiently rated and the transformers are massive in size, indicating that the cost was not held down at the expense of good design. All in all, this unit should require a minimum of service—an important consideration at all times.

# SLASH!! PRICES WAY DOWN DURING RECESSION, BUY NOW & SAVE! ALL PRICES QUOTED GOOD FOR 30 DAYS ONLY

## 50 WATT, 6 CHANNEL RADIOTELEPHONE FOR BOATS OR FIXED STATIONS

THE RADIOTELEPHONE BARGAIN all the Pleasure and Fishing Boats are talking about! This Transmitter-Receiver (BC-669 part of SCR-343) is beautifully and ruggedly built. Provides 6 fixed channels of crystal-control transmission and reception, in addition to manual tuning when desired for reception. Frequency range 1600 to 4500 KC. The BC-669 FCC currently accepted 2-3 mc marine band. With recommended 12 V. DC (or 24 V. DC) dynamotor power supply will deliver 50-60 watts output. Supplied with instruction book, connecting cable, power supply constructional data, all tubes, all tested and guaranteed. See our previous Send in Radio Today. Navy for illustration and complete data, or send for descriptive bulletin: 50 WATT RADIOTELEPHONE (BC-669 A, B, or C). USED-EXCELLENT, as described above. Shpg. wt. **\$99.50**

SAME AS ABOVE, NEW-UNUSED, EACH **\$139.50**

AS ABOVE, A, B, or C MODELS NOT TESTED. Schematic Diagram Supplied only. EACH **\$74.50**

12 V. DC POWER SUPPLY, for above. Has 2 Dynamos, one for transmitter and one for receiver, and one for receiver. Produces 50/60 watts output. All wired and tested. EACH **\$89.50**

COMPLETE 12 V. DC POWER SUPPLY KIT. Assemble and wire your own! All material and diagram. **\$45.00**

PE-110, A, B, or C POWER SUPPLY, for 110 V. 60 cycles AC operation. LIKE NEW condition. EACH **\$89.50**

HANDS OFF FOR ABOVE with appropriate connections. **\$14.50**

## 30-40 MC DELUXE FM RECEIVER FOR MOBILE POLICE & FIRE CALLS

This FM receiver, the VRC-2 Eopt., is a single channel-crystal radio receiver, with a cover including industrial, police, and fire dept. frequencies. It is of superior design and construction with all the latest features such as: double-conversion superhet (475 mc. I.F.'s) with both oscillators crystal-controlled, noise squelch, double limiter stages, 100% output, etc. Exceptionally well built to provide constant trouble-free service. Uses a total of 13 tubes, 2 in the detector-power section and 11 in the audio section. All units are in practically like-new condition and exceptionally clean. Dimensions with removable case illustrated above. **\$29.95**

PRICE, EACH. Not tested at this low price.

## FM TRANSCEIVER 29-39 MC

Signal Corps BC-659, part of popular SCR-343. 10 V. vehicular eopt. Combination Transmitter and Receiver for FM communications. 2-channels both crystal-controlled. Transmitter use not recommended except for military or special applications, but receiver is ideal for monitoring 29-39 mc. (I.F.'s) with both oscillators crystal-controlled. Incorporates built-in loudspeaker, and consists of such to permit easy under dash mounting to permit complete access to front panel controls. Separate power supply appropriate for 90 to 130 volts "B" supply, and 1.5 volts "A" supply. The PE-117 or 120, available separately, supplies these voltages from either a 6, 12 or 24 volts DC source, but batteries or other supply can be easily adapted. Dim. of Transceiver 16" L. x 13" W. x 7 1/2" H. Supplied complete with all tubes and Schematic Diagram. **\$14.95**

BRAND NEW, UNUSED, SLASHED TO **\$14.95**

Price PE-117, 120 (Specify which), Power Supply for above. Used-Good. **\$14.95**

## BC-312, 342 SIGNAL CORPS COMMUNICATIONS RECEIVER

Work horse of the Signal Corps, this popular Communications Receiver is a well known favorite of Amateurs, Communications experts and commercial operators. Receives CW, MCW and Phone over the frequency range of 1500 to 18000 KC in 6 Bands. Very ruggedly built, extremely stable and simple to operate. The speaker is a 5" B.F. loudspeaker output (separate speaker required), and smooth-operating vernier dial (with locking features) precision calibrated for exact tuning. The receiver is designed for 12 V. DC operation (excellent for marine application), but easily converted to 110 V. AC operation by substituting 110V. AC pack for present dynamotor pack. All units Used-Excellent Condition, thoroughly tested. Supplied Complete with tubes & Schematic Diagram. Shpg. wt. 70 lbs. **\$60.00**

EACH

RA-20 110 V. AC PACK, to convert to 110 V. AC operation. Like New, tested. Shpg. wt. 20 lbs. EACH **\$17.50**

INSTRUCTION BOOK, covers BC-312 & 342. Sold only with above. **\$1.50**

## LORAN RECEIVING EQPT., APN-4, AT LOWEST PRICE EVER!!!

We made a "buy" on this popular model APN-4 Loran unit, used on Fishing and Pleasure boats and Aircraft for navigational purposes. All are used but in Very Clean condition, complete with tubes and accessories. The set consists of an R9/APN-4 Receiver and an ID-6/APN-4 Indicator. Originally sold in surplus for \$100.00 or more per set, but now available for a fraction of that price. "Spare" while available at this real low price! Sorry, no accessories or inverter (80 to 115 V. AC, 400 to 2000 cycles, required) available here. Inverters for this eqpt. are available from many surplus houses. **\$25.50**

PRICE PER SET, each consisting of one Indicator and one Receiver, as above. Over 50 modern type tubes. Not Tested. Excellent-Used. Shpg. wt. 80 lbs.

All Above Material Subject to Prior Sale. 25% Minimum Deposit with All C.O.D.'s. Min. Order —\$5.00. All Prices F.O.B. Our Address.

— TELEMARINE —  
COMMUNICATIONS CO., INC.  
140 WEST B'WAY, NEW YORK 13, N. Y.  
PHONE: COlland 7-5444  
Cable Address: Telemarine N. Y.

## NEW, WALKY-TALKY (BC-611) CHASSIS

Here's the chance to build your own real compact, lightweight hand-held Walky-Talky! Designed to transmit and receive on one (or two) control-dial frequency between 3.0 and 6.0 mc., any real Ham could revamp the coils for operation on high frequency amateur phone bands. This will result in increased antenna power output and longer distance transmission. By building your own case for this chassis, with space for larger batteries and increased B voltage, further increased power and longer service from batteries will result. These chassis are NEW, unused, complete with telescoping antenna but less tubes, coils, or crystals. Tubes required: 1-1R5, 1-1S5, 1-1T4, and 2-3S4, 2 miniature plug-in coils required (sold separately). An Antenna (not included) will require 150 voltages required (original) 1-1.5 volt "A" and 103.5 volts "B" battery, the latter may be increased to 135 or 167.5 volts to produce higher transmitter output. Supplied as specified with Schematic diagram. Shpg. wt. 6 lbs. **\$8.95**

EACH Chassis complete with 2 coils. PAIR OF COILS, for above. Ant. & RF Tank... **\$1.25**

SEE OUR PREVIOUS ADS IN RTN FOR ACCESSORIES & PRICES

## LIMITED QUANTITY BARGAINS

FLASH!! READ THIS! WIRE RECORDING MAGAZINE. Complete assembled magazine consisting of following items: 1 supply reel, 1 sheet metal case with approx. 9,000 ft. stainless steel wire .004 dia. (at rated speed of 2 1/2 ft. per second will provide 1 hour recording and playback) 1 turntable with brake shoes, elapsed time indicator, level winding shaft and guide, reel bearings and sleeve, erasing heads, recording-reproducing head, forward and reverse limit switches, magazine bridge, wire guide mechanism, 2 spined reel shafts, latching studs, electrical contacts, etc. Wired, for 115 volt, 60 cycles AC, 85 watts, less drive motor. Enclosed in anti-static, fireproof, removable enclosure with top front glass covered opening 4" L. x 3 1/2" W. and a scaled 60 minute dial, graduated in 10 minute divisions. Order in quantities of 10, L. x 4 3/8" H. x 2 5/8" D. Mfd. by Brush Development Co. NEW-UNUSED units. Does not include erasing oscillator (20-30 KC) or amplifier. Shpg. wt. 15 lbs. **\$6.95**

12 VOLT DC TO 120 V. AC ROTARY INVERTER FOR BOAT OR CAR. Output 3.1 amps, 60 cycles AC from any 12 volt car or boat battery. Permits using 110-120 volt AC vacuum or equipment, such as refrigerator or TV, appliances, etc. Horizontal type with carrying handle, approx. 12 1/2" long x 6 3/4" W. x 10 1/2" H. All NEW-UNUSED units. Shpg. wt. 75 lbs. **\$49.95**

WHILE THEY LAST, EACH.....

2-CHANNEL FM TRANSCEIVER, 29.0-39 MC. The BC-1335 is an 18 miniature tube FM transmitter-receiver with final output of 1.5 watts. Range, under average conditions, to 10 miles, when used as a fixed station. Incorporates vibrator-type power supply which operates from either 6 or 12 V. DC. Both channels crystal-controlled. Tubes, 73 and 81, and other details. Shpg. wt. 45 lbs. Used, excellent, with tubes. **\$19.95**

PRICE, EACH, Not Tested. SLASHED TO.....

BC-683 FM MOBILE RECEIVER. Ideal for car or truck installation for monitoring Police, Fire calls, etc. Operates on 12 V. DC, but easily converted to 110 V. AC operation using an RA-20 AC power pack. Tuning Range 27.0 to 39.0 mc. with ten push-buttons for instant selection of any preset frequencies within this range. Incorporates loudspeaker, squelch circuit, double limiter stages, headphone jacks, etc. Complete with tubes, dynamotor, schematic diagram. Shpg. wt. 65 lbs. **\$24.95**

PRICE, EACH, used—excellent, not tested.....

BC-791 CODE RECORDER. Consists of Amplifier and Recorder of code signals on paper tape, with ink writing strip. Similar to McNelroy Model BRD-90. Requires 110 V. AC, less tape puller. Housed in oak case, all NEW Units. Shpg. wt. 40 lbs. **\$10.95**

EACH, SLASHED TO.....

6 or 12V. DC VIBRATOR POWER SUPPLY. Type PE-104, operates on either voltage and provides completely filtered voltages as follows: 1.5, .45 (bias), and 90 volts DC. Uses synch. vibrator, no tubes. Ideal for mobile transmitters, etc. Dimensions 6 1/2" x 6 1/2" x 6 1/2". NEW UNITS. Shpg. wt. 12 lbs. EACH..... **\$9.95**

12V. DC, 1/2 HP DC MOTOR. Make electric car or tractor for kiddies. Rated at 1/2 HP at 1725 rpm, but with built on reducing gear assembly actually develops more power at 800 rpm. Motor has 1/2" brass worm gear available separately for 2 1/2 rpm. NEW. Material. MOTOR EACH..... **\$12.95**

Worm Gear, 1/2" for 2 1/2 rpm..... **\$2.75**

MALLORY 12V. DC VIBRAPACKS. Model 12B300C. Output 300 V. at 100 ma. Dim: 6" H x 4 1/2" D x 3 1/2" W. Supplied with vibrator but less Raytheon 8X Rectifier tube (required). Like New Condition. Shpg. wt. 17 lbs. EACH..... **\$6.95**

## POGO STICK WALKY-TALKY

Sensational Hi-Efficiency Walk-Talky known as BC-745 (Trans-Receiver) part of SCR-511 used widely by CAP. Excellent for emergency communications (especially for small boats on the "Safety & Calling" frequency of 2182 KC) and for liaison patrol work. Frequency range 3.0 to 6.0 mc. easily raised or lowered by removing or adding turns to Ant. & Osc. coils in plug-in tuning units. Power output 47.5 Watt. Crystal control of transmitter and receiver. Plug-in Tuning Units (BC-746) with crystals employed for frequency changing. Uses 6 miniature tubes in modern superhet receiving circuit, and miniature 354 Power tubes in transmitter. Modulation is 100% Plate type. Telescopic rod antenna turns power "on" or "off" when extended or retracted. New! The BC-745 Transmitter-Receiver may be used with Chest Unit T-39, which houses the necessary dry batteries consisting of 1 1/2 V. "A" battery and two 37.5 V. "B" batteries and speaker microphone unit. Or, it may be used with the PE-157 Power Supply, which supplies all necessary voltages from a standard 110 volt AC line. This power supply has a built-in loudspeaker, but provides for separate headphones and microphone. PRICE BC-745 POGO STICK WALKY-TALKY, with tubes, connecting cord CD-571, and 1 BC-746 Tuning Unit. USED, GOOD CONDITION, **\$39.50**

Shpg. wt. 15 lbs. EACH, NEW CONDITION—EACH **\$59.50**

CHEST-UNIT T-39, Excellent Condition. Shpg. wt. 5 lbs. EACH..... **\$15.00**

POWER SUPPLY PE-157, less 2 Volt Storage..... **\$15.00**

EXCELLENT CONDITION. Shpg. wt. 15 lbs. EACH..... **\$19.50**

ADDITIONAL BC-746 TUNING UNITS, with crystals, specifically designed for frequencies of 2182 KC. **\$2.50**

SPARE TRANS-RECEIVER CHASSIS, NEW, less tubes. Shpg. wt. 8 lbs. EACH..... **\$10.95**



# TRANSISTOR RADIO REPAIRS NOW EASY!

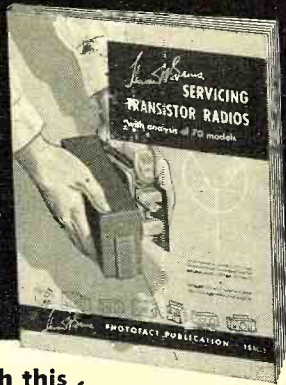

with this

NEW *Howard W. Sams* BOOK

## "SERVICING TRANSISTOR RADIOS"

COMPLETE ANALYSIS OF 70 POPULAR TRANSISTOR RADIO MODELS



includes new General Motors (Delco) Transistorized Auto-Portable Radio

Also Valuable Section—  
"BASIC POINTERS ON SERVICING TRANSISTORIZED RADIOS"...

### COVERS LATEST MAKES AND MODELS

This book helps you earn big profits on Transistor Radio repairs—gives you complete, time-saving information—helps you become an expert on transistorized radios! Complete data on 70 latest models is based on actual lab analysis of each set. You get the famous Sams Standard Notation schematics—accurate, big, legible; full photo views of each chassis, with all components identified; complete alignment instructions; complete parts lists with full replacement data—everything you need to be successful in fast-growing transistorized radio servicing. Here's a "must" book for your bench. Order it now!

152 pages; 8½ x 11" **\$2.95**  
PRICE ONLY.....

SEE THIS BOOK AT YOUR SAMS DISTRIBUTOR OR MAIL COUPON

### FREE TRIAL COUPON

Howard W. Sams & Co., Inc., Dept. 1-FF8  
2201 E. 46th St., Indianapolis 5, Ind.

Send me Sams "Servicing Transistor Radios" for 10 days FREE examination. In 10 days I will pay for the book, plus few cents delivery cost, or return postpaid.

We pay delivery costs if you remit with this coupon; same return privilege.

Name \_\_\_\_\_

Address \_\_\_\_\_

City \_\_\_\_\_ Zone \_\_\_\_\_ State \_\_\_\_\_

(Outside U.S.A. priced slightly higher)

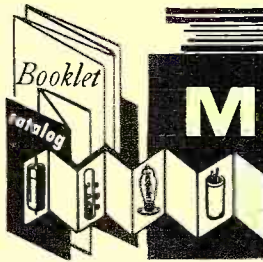

# Manufacturers' Literature

### ENGINEERING JOB TIPS

As a service to individuals, college placement officers, and personnel directors, *CGS Laboratories, Inc.*, 391 Ludlow St., Stamford, Conn. has issued a 13-page booklet entitled "Getting an Engineering Job."

Written by Elton T. Barrett, president of the firm, the publication is an outgrowth of hundreds of job interviews with graduating electrical engineers. Instead of presenting rigid and exact answers, the booklet is intended primarily to encourage the graduating engineer to plan his career wisely and avoid some of the pitfalls which seem obvious to more experienced engineers.

The booklet attempts brief answers to such questions as: "What does an employer want?"; "How should I interview and be interviewed?"; "How can I get the best job for me?"; and "How can I be successful on the job?"

Copies of this career guidance booklet are available without charge upon written request.

### RELAY DATA

*Universal Relay Corporation*, 42 White Street, New York 13, N. Y. is now offering a new 32-page catalogue covering its line of relays, steppers, solenoids, rectifiers, and other electronic components.

Copies of this new publication are available without charge upon written request.

### LAFAYETTE FLYER

*Lafayette Radio*, 165-08 Liberty Ave., Jamaica 33, N. Y. has issued a colorful 28-page flyer which lists hundreds of bargain items for the audiophile, service technician, hobbyist, and experimenter.

Special prices apply in every category of equipment listed. For a free copy of Catalogue 307, write the distributor direct.

### TV REPLACEMENTS

*Chicago Standard Transformer Corporation*, 3501 W. Addison St., Chicago 18, Ill. has issued a 100-page guide devoted exclusively to TV replacement transformers including flybacks, yokes, power, vertical outputs, etc.

Designed specifically for service technicians, the catalogue lists over 7000 models and chassis of 98 manufacturers. It is printed in a large, easily read type and a new format permits immediate location of the part required. Each manufacturer's models and chassis are listed individually in numerical order making it unnecessary to know the original part number.

The catalogue sections lists over 300 TV replacement transformers including 172 flybacks. Copies are available from any *Stancor* distributor or from the manufacturer direct.

### ELECTRICAL CONTACTS

*Gibson Electric Company*, Box 638, Delmont, Pa. has just issued a revised and expanded general catalogue covering its line of electrical contacts.

Discussed in this 16-page booklet are contacts made from fine silver, palladium and nickel, silver alloys including coin silver and silver alloys, as well as silver cadmium oxides and many powdered metal compositions designated as "Gibsilloys."

An especially useful feature of the catalogue is an outline showing the most suitable contacts for various applications. These applications include alarms, bells and buzzers, contactors, domestic appliances, instruments, rheostats, signalling equipment, sliding contacts, tap changers, thermostats, etc.

Copies of the new catalogue are free. Please specify General Catalogue C-520.

### LINE VOLTAGE CORRECTOR

*Electromatic Industries*, 3000 Taft St., Hollywood, Fla. is offering a one-page data sheet which describes its self-adjusting line-voltage corrector in some detail.

The unit, designed to be used with TV receivers, hi-fi units, radio sets, tape recorders, ham gear, etc., has an input range of from 75 to 135 volts, 60 cycles. The data sheet gives complete electrical and mechanical specs on eight different models for various home and commercial applications.

Write the manufacturer direct for a copy of the data sheet and prices on the units.

### TUBE DATA BOOK

*Raytheon Manufacturing Company*, 55 Chapel Street, Newton 58, Mass. has just issued a new and completely revised receiving tube data book containing over 50 pages of pertinent electrical and mechanical operating characteristics for approximately 1000 TV and radio tube types.

Current to within thirty days of issue, this new book carries all types on which information is available, including the latest in series-string and color tubes. Featured throughout the book is large, easy-to-read type. Over 600 basing diagrams are conveniently located on the same page as the type information. Two full pages of tube outline drawings for all classes of receiving

RADIO & TV NEWS



tubes are provided as well as one full page on the company's panel lamp characteristics.

Copies of this book are available from local authorized *Raytheon* tube distributors for 50 cents each.

#### EIA BOOKLET

Electronic Industries Association, 1721 DeSales St., N.W., Washington 6, D. C. is currently releasing copies of its new booklet, "Recruitment, Selection, and Development of Personnel" to over 1700 of the nation's electronic parts distributors.

Prepared by the Jobber Relations Committee of the EIA, the new publication is designed to assist electronic parts distributors in accelerating the solution to some of their major business problems.

The cost of the project has been underwritten by the 21 companies represented on the committee in the hope that it will encourage the distributor to do a better job. In addition to the initial distribution, extra copies of the publication will be available to distributors, on request, through EIA headquarters.

#### SERVICE TOOL CATALOGUE

*CBS-Hytron's* Tube Division has issued a revised tool catalogue for electronic technicians and engineers.

Featured in it are two new printed-circuit soldering aids, miniature versions of the original standard soldering aids introduced by the company. A new, bigger, and handier tube and tool caddy is also described. The catalogue includes miniature pin straighteners, tube pullers and lifters, probing tweezers, tube test adapters, a solder dispenser, and a four-way screwdriver.

A free copy of this tool catalogue is available by writing the Advertising Service of the company at Parker Street, Newburyport, Mass. and asking for the PA-6 tool catalogue.

#### TRANSISTOR SPECS

*Industro Transistor Corporation*, 35-10 36th Avenue, Long Island City 6, N. Y. is offering a newly revised transistor specification chart which covers the *p-n-p* germanium alloy junction transistors in the company's line.

The chart also contains an interchangeability guide covering transistors of all manufacturers for computer, entertainment, and industrial applications.

#### ARGONNE CATALOGUE SHEET

*Argonne Electronics Mfg. Corp.*, 165-11 South Road, Jamaica 33, N. Y. has issued a one-page, two-color data sheet which describes its Model AR-3 all-purpose dynamic microphone and a complete line of synthetic sapphire phono styli for replacement and new-equipment applications.

The data on the styli includes interchangeability information for *Walco* and *Jensen* needles and the original manufacturer's cartridge number.

Copies of this catalogue sheet are available without charge.



## FOREIGN CAR RADIO PROBLEM SOLVED!

### KARADIO AUTO RADIO

Custom-fit for VOLKSWAGEN, RENAULT, ENGLISH FORD and other foreign cars

- 5 1/4" shaft opening to fit all standard foreign car dash boards.
- 6 3/4" wide x 4" high x 7" deep
- For 6 and 12 volt systems

**\$34.95**

Dealers Net (A \$52.50 value!)

This is it . . . the car radio for all foreign cars at sensational savings. Features include a heavy-duty self contained speaker; 6 tubes. Operates on frequency range 540 KC to 1600

KC; intermediate frequency 455 KC. Comes complete with mounting bracket, parts and instructions. Special adapter plates available. Separate speaker models also available.

From the World's Largest Manufacturer of Auto Antennas

### famous MERLIN ANTENNAS

Mounts on Every Type of Cowl or Fender

SIDE COWL MOUNTS	MAST EXTENSION	LENGTH	LIST PRICE
Model SC-60 (3 section)	60"	36"	\$ 3.75
TOP COWL AND FENDER MOUNTS			
Model CFT-3 Chevrolet 1958 Replacement	54"	36"	5.15
Model CF-3 (3 section) Concealed	57"	60"	5.95
Model CR-3 1957 Chevrolet Replacement	54"	36"	5.15
Model FR-3 1957 Ford Replacement	57"	48"	4.25
Model MM-57 (3 section) Rocket "Leader"	57"	54"	3.65
Model TC-50 (3 section) Standard Screwball	50"	54"	3.25
Model TM-1 New Universal. Electric Antenna. Fits all 12 volt cars. (3 section)	48"	54"	29.95
DUAL MOUNTS (One Active)			
Model RMT "Snorkle." (3 section)	27" w/15' cable		\$12.95



**SCOOP! SKIL PORTABLE POWER TOOLS**  
 1/4" Drill, heavy-duty, power packed, Deluxe. Full 2-amp motor. Up to 35% more power. Quality trigger switch w/lock button. Quality Jacobs chuck. **\$14.95**  
 a sensational buy at



Model CF-3

Mast Completely Disappears

### NEW AUTO RADIOS

1953-4 Chev., 6 tube manual, Model CTM4M	\$29.95
1955-6 Chev., 6 tube manual, Model CTM6M	29.95
1957 Chev., transistor powered, Model CTM7X	32.95
1958 Chev., transistor powered, Model CTM8X	34.95
1957 Chev., push button, Model CTM7X	41.95
1954 Ford, 6 tube manual, Model FDM4	29.95
1957-8 Ford, 6 tube manual, Model FDM8	29.95
1955 Plymouth, 6 tube manual, Model PH5M	29.95
1956 Plymouth, 6 tube manual, Model PH6M	29.95
1957-8 Plymouth, 6 tube manual, Model PH8M	32.95
1955-6 Pontiac, 7 tube, PB, GM #984961	37.50
1958 Pontiac, PB, Model CT47XP	47.95
1955 Mercury, PB, 8 tube, Model MY5P	34.95
1956 Mercury, PB, 8 tube, Model MY6P	34.95
1957 Mercury, PB, 8 tube, Model MY7P	34.95
1958 Mercury, PB, 8 tube, Model MY8P	34.95
1957 Volkswagen, PB, Model VWA7	41.95
MO-PAR	
1957-8 Dodge, 6 tube manual, Model 624	34.95
1956 Chrysler, PB, Model 844	44.95
1956 De Soto, PB, Model 911	44.95
1956 Plymouth, PB, Model 841	44.95
1956 Dodge, PB, Model 842	44.95
1956 Dodge, Manual, Model 621	34.95

**BONUS!!**

FREE...3-Sectional

ANTENNA

with every order

of

\$100 or more

Inquiries Invited. Fast C.O.D. shipment F.O.B. N. Y.

## Liberty Auto Radio, Inc.

191 East 161 Street • New York 51, N. Y. • LUdlow 8-7111



# FREE LAFAYETTE CATALOG

A Must For Every Hi-Fi Enthusiast

New! Years Ahead!



## NEW 180 PAGE ELECTRONIC CATALOG FEATURING THE BEST BUYS IN THE BUSINESS

The newest and largest assortment of Electronic, Radio and TV parts, Hi-Fi and Public Address Components and systems, Test Equipment, tubes, Transistor Kits and miniaturized components for transistor circuitry, Ham Equipment, Builders Kits, Tools, Books, Microscopes, Binoculars, Telescopes, Cameras, and Drafting Equipment.—ALL AT LOWEST PRICES—Catering to the economy minded dealer, serviceman, engineer, technician, experimenter and hobbyist. **CRAMMED FULL OF MONEY SAVING BUYS. SEND FOR YOUR FREE COPY TODAY.**

# LAFAYETTE STEREO TUNER KIT

## THE MOST FLEXIBLE TUNER EVER DESIGNED



KT-500 IN KIT FORM  
**74.50**

ONLY 7.45 DOWN  
7.00 MONTHLY

- Multiflex Output for New Stereo FM • 11 Tubes (including 4 dual-purpose) + Tuning Eye + Selenium rectifier Provide 17 Tube Performance • 10KC Whistle Filter • Pre-aligned IF's • Tuned Cascade FM • Separately Tuned FM and AM Sections • Armstrong Circuit with FM/AFC and AFC Defeat • 12 Tuned Circuits • Dual Cathode Follower Output • Dual Double-Tuned Transformer Coupled Limiters.

More than a year of research, planning and engineering went into the making of the Lafayette Stereo Tuner. Its unique flexibility permits the reception of binaural broadcasting (simultaneous transmission on both FM and AM), the independent operation of both the FM and AM sections at the same time, and the ordinary reception of either FM or AM. The AM and FM sections are separately tuned, each with a separate 3-gang tuning condenser, separate flywheel tuning and separate volume control for proper balancing when used for binaural programs. Simplified accurate knife-edge tuning is provided by magic eye which operates independently on FM and AM. Automatic frequency control "locks in" FM signal permanently. Aside from its unique flexibility, this is, above all else, a quality high-fidelity tuner incorporating features found exclusively in the highest priced tuners.

FM specifications include grounded-grid triode low noise front end with triode mixer, double-tuned dual limiters with Foster-Seeley discriminator, less than 1% harmonic distortion, frequency response 20-20,000 cps  $\pm 1/2$  db, full 200 kc bandwidth and sensitivity of 2 microvolts for 30 db quieting with full limiting at one microvolt. AM specifications include 3 stages of AVC, 10 kc whistle filter, built-in ferrite loop antenna, less than 1% harmonic distortion, sensitivity of 5 microvolts, 8 kc bandwidth and frequency response 20-5000 cps  $\pm 3$  db.

The 5 controls of the KT-500 are FM Volume, AM Volume, FM Tuning, AM Tuning and 5-position Function Selector Switch. Tastefully styled with gold-brass escutcheon having dark maroon background plus matching maroon knobs with gold inserts. The Lafayette Stereo Tuner was designed with the builder in mind. Two separate printed circuit boards make construction and wiring simple, even for such a complex unit. Complete kit includes all parts and metal cover, a step-by-step instruction manual, schematic and pictorial diagrams. Size is 13 $3/4$ " W x 10 $3/8$ " D x 4 $1/2$ " H. Shpg. wt., 18 lbs.

The new Lafayette Model KT-500 Stereo FM-AM Tuner is a companion piece to the Models KT-300 Audio Control Center Kit and KT-400 70-watt Basic Amplifier Kit and the "Triumvirate" of these 3 units form the heart of a top quality stereo hi-fi system.

KT-500.....Net **74.50**

## LAFAYETTE MASTER AUDIO CONTROL CENTER with BINAURAL CHANNEL AND DUAL VOLUME CONTROL.

- Self-Powered • DC On All Filaments • 24 Positions of Equalization • Tape Head Input, High Impedance. • Dual Cathode Follower Output Stages

This is not only the finest hi-fi preamp characterized by unmatched features, but it has been functionally designed to keep pace with the conversion of your present hi-fi system to binaural (Stereophonic) sound. Incorporates an extra channel and dual volume control for binaural reproduction. Features include DC on all tube filaments, negative feedback in every stage, dual cathode follower output stages and latest printed circuit construction. Less than 0.09% IM distortion and less than 0.07 harmonic distortion at 1V. Hum and noise level better than 80 db below 3V. Uniformly flat frequency response over entire audible spectrum. 7 inputs for every type of phono, tuner or tape. Tasteful styling, brilliantly executed. Size 12 $3/4$  x 9 $1/2$  x 3 $3/4$ ". Shpg. wt., 10 $1/2$  lbs.

KT-300—Lafayette Master Audio Control Kit Complete with cage and detailed assembly instructions. Net **39.50**

LT-30—Same as above completely wired and tested with cage and instruction manual. Net **59.50**

## DELUXE 70 WATT BASIC AMPLIFIER

- Conservatively Rated At 70 Watts • Inverse Feedback • Variable Damping • Metered Balance And Bias Adjust Controls • Available In Kit and Wired Form
- Here's ultra-stability in a 70 watt basic power amplifier employing highest quality components conservatively rated to insure performance and long life. Features matched pair KT 88's and wire range linear Chicago output transformer, variable damping control, meter for bias and balance and gold finish chassis. Frequency response 10-100,000 cps  $\pm 1$ db. Hum and noise 90 db below full output. IM distortion less than 1 $1/2$ % at 70 watts, less than 0.3% below 30 watts. Harmonic distortion less than 2% at 70 watts from 20 to 20,000 cps  $\pm 1$  db. Output impedance 4, 8 and 16 ohms. Handsome decorative cage perforated for proper ventilation. Size 14 $1/2$  x 10 x 7 $3/8$ " including cage and knobs. Shpg. wt., 40 lbs.

KT-400—Lafayette 70 watt Deluxe Basic Amplifier Kit complete with cage and detailed assembly instructions. Net **69.50**

LA-70—Same as above completely wired and tested with cage and instruction manual. Net **94.50**



KT-300 IN KIT FORM  
**39.50**



KT-400 IN KIT FORM  
**69.50**

ONLY 6.95 DOWN  
7.00 MONTHLY

## NEW! LAFAYETTE SCOOP!

### DUAL WIDE-ANGLE TWEETER



Only **5.95**

#### Modernize Your Hi-Fi System

Modernize your high fidelity listening by adding this wide-angle dual-tweeter to extend treble range in a 2-way or 3-way speaker system. Mounts directly on any 12" speaker and converts it to a coaxial type. Response 2500 to 16,000 cps. Recommended crossover 2500 to 4000 cps. Heavy magnets for high efficiency. Dispersion angle approx. 125° horizontally. Impedance 16 ohms (2-8 ohm units in series). Will handle up to 20 watts program in 2 or 3-way systems. Incorporates specially designed chrome-plated steel bracket of rigid construction to prevent resonances. Measures 12" L x 2" D x 2 $3/8$ " H overall. Shpg. wt. 2 lbs.

SK-100 Dual Tweeter.....Net **5.95**

Lafayette Radio

DEPT RF

P. O. BOX 511  
JAMAICA 31, N. Y.

Send FREE LAFAYETTE Catalog 305

Name ..... CUT OUT AND MAIL TODAY  
Address .....  
City..... Zone.... State.....



# LAFAYETTE PROFESSIONAL TURNTABLE

with AUTHENTIC HYSTERESIS SYNCHRONOUS MOTOR

Value ~~129.50~~ Only **64.50**  
SAVE OVER 50%

## PROFESSIONAL TURNTABLE WITH HYSTERESIS-SYNCHRONOUS MOTOR

The Lafayette Model PK-225 is a true hysteresis-synchronous motor and is free from speed variations due to fluctuations in line voltage, load and temperature. It is the smoothest type known, completely free from "cogging" (the minute variations of speed which show up as wow and flutter)

**ONLY LAFAYETTE'S HYSTERESIS-SYNCHRONOUS MOTOR**, in its price class, is made to extremely fine tolerances (on the order of .00001 inches)! Only Lafayette's motor has 16 cores; a high permeability rotor magnet, ball thrust bearings, oilite sleeve bearings plus felt oil reservoir, coating fins as an integral part of the rotor and a hollow rotor core for maximum efficiency and minimum heat. Only Lafayette's motor can be oiled from above, without disassembly, through a unique oil feed system. Only Lafayette's motor has a self-aligning armature.

Here's THE turntable—the last word in professional high-fidelity performance! A fine precision instrument in every sense. Just look at some of these **OUTSTANDING FEATURES:- WOW AND FLUTTER:** Less than 0.2%. • **TURNTABLE:** Heavy, diecast aluminum. Lathe-turned for perfect balance and concentricity. 12" diameter—weighs approx. 4 lbs. and provides amazingly constant speed; the extra-heavy rim acts just like a flywheel to prevent speed variations • **TRUE-HYSTERESIS-SYNCHRONOUS MOTOR:** For smooth, low-noise, wow- and flutter-free operation • **RUMBLE: AND NOISE:** 50db below average recorded level • **INTEGRATED SPEED CONTROL:** For all 3 speeds—78, 45 and 33 1/2 rpm • **2 OVERSIZE, HEAVY DUTY IDLERS:** Precision-ground; provide positive constant-speed rim drive • **SINGLE BALL THRUST BEARING:** Turntable rides smoothly over ball bearing floating on thin film of oil • **FREE FLOATING SHOCK-MOUNTED MOTOR** • **RUBBER CUSHION SHOCKMOUNTS** • **AUTOMATIC IDLER DISENGAGEMENT** • **CORK AND RUBBER MAT** • **STAINLESS STEEL PRECISION SPINDLE** • **POWER REQUIREMENTS:** For 105-130 volts, 60 cps AC; draws 16 V.A. • **ACCESSORIES SUPPLIED:** 45 RPM adapter, Srape disc • **SIZE:** 2 1/8" above and 4" below motor board; 14 1/4" deep x 12 1/4" wide • **SHIPPING WEIGHT:** 16 lbs.

LAFAYETTE MODEL PK-225 ..... Net **64.50**  
Deluxe Woodbase for PK-225 and 12" Tone Arm (Specify Finish). Shpg. wt., 13 lbs. .... Net **14.95**  
Deluxe Woodbase for PK-225 and 16" Tone Arm (Specify Finish). Shpg. wt., 15 lbs. .... Net **15.95**

LAFAYETTE MODEL PK-225



## VISCOUS DAMPED TRANSCRIPTION TONE ARMS



PK-90—**11.95**

VISCOUS DAMPED ARM

LICENSED UNDER CBS U. S. PATENT NO. 2676806



PK-170—**17.95**

VISCOUS DAMPED ARM

## SPECIAL MONEY-SAVER COMBINATION

PK-225 Turntable, PK-90 12" Tone Arm, New GE VR11 Series Triple-Play Cartridge Model 4G-052 with Genuine GE Diamond and Sapphire Styli. **SPECIAL!** ..... Net **81.50**

# TINY 6 TRANSISTOR RADIO

• LIGHT • SMALL • SENSITIVE  
**LOW PRICE HIGH PERFORMANCE**

- PUSH-PULL AUDIO OUTPUT FOR FAITHFUL TONE QUALITY
- FULL TONE DYNAMIC SPEAKER
- BUILT-IN FERRITE BAR ANTENNA
- TROUBLE-FREE PRINTED CIRCUIT
- 6 ULTRA-MODERN TRANSISTORS PLUS GERMANIUM DIODE
- SUPERHETERODYNE CIRCUIT
- HIGHLY STYLED PLASTIC CASE
- EARPHONE JACK—BUILT IN—FOR PRIVATE LISTENING
- ECONOMICAL—USES ONLY ONE BATTERY

SIZE: 1 3/8" x 2 3/4" x 4 5/8" WEIGHT: 12 OUNCES  
FS-110 — LAFAYETTE "TINY" TRANSISTOR RADIO COMPLETE with Battery, Carrying Case and Earphone ..... Net **29.95**

REGULARLY

~~48.50~~

**29.95**

Including Earphone, Battery and Carrying Case

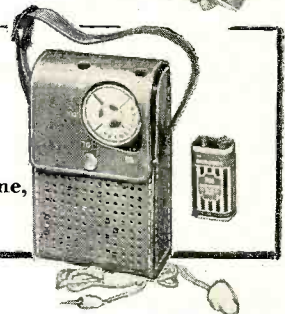
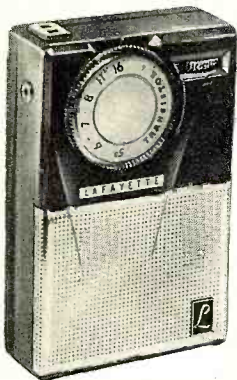

# NEW! POWER MEGAPHONE... Portable Sound Broadcaster

- Uses 8 Flashlight Cells • Completely Self-Contained
- Weighs only 6 1/2 lbs. with Batteries • High Efficiency
- Horn Projects Sound 1000 Ft. • Shoulder Strap for Portability and Ease of Use • Microphone Detachable On 10-Foot Cord • For Construction, Auctions, Carnivals, Fire & Police Use • Also Ideal for Marine, Railroad, Civil Defense, Sporting Events

A power megaphone with many unusual features and many applications. Basically a highly efficient sound projector horn with a built-in microphone, capable of amplifying and projecting the voice with a range of 1000 feet. The microphone is a telephone-type element, easily replaceable, and may be detached and extended up to 10 feet from the horn. The reflex-type horn is extremely light-weight, rubber-rimmed, of strong, sturdy spun aluminum construction with 2 3/4" air column and is supplied with a strap for carrying or placing on the shoulder. A press-to-talk switch on the microphone provides for economy of power use—power is used only when actually talking. No warm-up time required—amplification is instantaneous. A patented non-linear current limiting device restricts current flow to safe levels for longest battery life. Uses 8 size "D" flashlight cells in series with an approximate life of about 10 hrs. of use. Battery housing serves as base for entire assembly. Battery compartment opens easily by means of 2 thumbscrews for battery replacement. Size 17" long overall; horn mouth is 12" diam. Shpg. wt., 8 lbs. less batteries.

PA-13—Power Megaphone, Less batteries.....Net **29.50**

**BATTERIES FOR ABOVE**—Burgess No. 2 or RCA VS036—8 Required .....Net each **.13**

Reg. Value ~~69.50~~

ONLY **29.50**



Self-Contained—Only 6 1/2 lbs. THROWS VOICE 1000 FT.

SHOULDER STRAP & DETACHABLE MIKE JUST AIM & TALK



*Lafayette Radio*

165-08 Liberty Ave. JAMAICA 33; N. Y.

INCLUDE POSTAGE WITH ORDER

NEW YORK, N.Y. 100 8th Ave. N.Y.C. 2-8600

BOSTON, Mass. 110 Federal St. Woburn 2-7950

BRONX, N.Y. 342 E. Fordham Rd. Fordham 7-8813

NEWARK, N.J. 24 Central Ave. Market 2-1661

PLAINFIELD, N.J. 139 W. 2nd St. Plainfield 6-4718



*Get*  
Your First Class Commercial  
**F.C.C. LICENSE**  
in  
**12 Weeks!**

**F.C.C. License—the Key to Better Jobs**

An FCC commercial (not amateur) license is your ticket to higher pay and more interesting employment. This license is Federal Government evidence of your qualifications in electronics. Employers are eager to hire licensed technicians.

**Learn by Mail or in Resident Classes**

Grantham School of Electronics specializes in preparing students to pass F.C.C. examinations. Correspondence training is conducted from Washington and Hollywood; resident DAY and EVENING classes are held in both cities. Either way, we train you quickly and well—NO previous training required. A beginner may qualify for his first class F.C.C. license in as little as 12 weeks.

**Here's Proof** A few of our recent graduates, the class of license they got, and how long it took them:

	License	Weeks
Edward Dahl, 7800 Old Chester Rd., Bethesda, Md.	1st	11
Griffin Kane, 3125 Wabash Ave., Los Angeles, Calif.	2nd	9
Beamon Meares, 1536-17th St., NW, Washington, D.C.	1st	11
Larry Pacifico, 65 Main St., Roseto, Pa.	1st	12
Tooru Iwahashi, Honolulu, Hawaii	2nd	8
Basil D'Imperio, 2223 H St., NW, Washington, D.C.	1st	12
John Ward, 407 E. Cowden Ave., Midland, Texas	1st	10
Herbert Halbig, 315 Park St., Tupper Lake, N. Y.	1st	11
Vragh Godoshian, 312 E. Wilson St., Pontiac, Mich.	1st	11
Antone Mello, 68 Union St., Nantucket, Mass.	1st	10
James Farish, 926 Cardone Ave., Reno, Nev.	1st	12
Charles Page, General Delivery, Yuma, Ariz.	1st	16
E. H. Siddall, 13951 Magnolia Ave., Van Nuys, Calif.	2nd	8
James Craig, 4004 - 19th St., S., Arlington, Va.	1st	11

**Grantham's Communications Electronics Course**

offers you complete preparation for F.C.C. examinations required for a first class F.C.C. license. Even though it is planned primarily as preparation for F.C.C. examinations, it is not a "cram course" but prepares you by TEACHING you electronics.

**OUR GUARANTEE**

If you should fail the FCC exam after finishing our course, we guarantee to give you additional training at NO ADDITIONAL COST. Read details in our free booklet.

**FCC-TYPE EXAMS**

FCC-type tests are used throughout the Grantham course. Constant practice with these FCC-type tests helps you prepare for the actual FCC examination.

**TWO COMPLETE SCHOOLS:** To better serve our many students throughout the entire country, Grantham School of Electronics maintains two complete schools—one in Hollywood, California and one in Washington, D. C. Both schools offer the same rapid courses in FCC license preparation, either home study or resident classes.

**MAIL TO SCHOOL NEAREST YOU**

(mail in envelope or paste on postal card)

**Grantham Schools, Desk 86-G**

1505 N. Western Ave. Hollywood 27, Calif. OR 821 - 19th Street N.W. Washington 6, D. C.

Please send me your free booklet telling how I can get my commercial F.C.C. license quickly. I understand there is no obligation and no salesman will call.

Name .....

Address .....

City ..... State .....

I am interested in:  Home Study,  Resident Classes



**MILWAUKEE ASSOCIATION OF RADIO & TV SERVICE**

BACK IN November 1952, Milwaukee service independents had their hands full. With the industry having gone through some severe growing pains, there were still many unsolved problems. Prominent among these were the unfair and unethical practices among a small per-cent of independents, which were placing an unjust handicap on the greater number of honest shops. In this atmosphere, a number of ethical service dealers came together to form MARTS—the Milwaukee Association of Radio and Television Service—with the hope of bringing a solid and respectable base to independent service out of the chaos. Today, 5½ years later, MARTS is 50 service dealers strong.

First, the founders felt, they had to do something about the ever-increasing complaints concerning TV service that were pouring into the offices of the Better Business Bureau and the DA. A basic code of ethics was drawn up. With the cooperation of local business organizations, newspapers, and the DA, several illegitimate shops were exposed and forced to close their doors. To put teeth into the code of ethics, MARTS set up a grievance board to investigate customer complaints. In the early days, there were quite a few gripes.

This active Milwaukee group, located at 2401 N. Weil St., Milwaukee 12, Wisconsin, meets in various locations around the city on the third Tuesday of every month. Chief qualification for membership, as in the case of most associations, is ownership of one's own TV service shop. Officers are elected annually in February, the incumbents including C. J. Hausknecht, president; Joseph Bates, vice-president; Larry R. Dorst, secretary; and Gerald Hall, director for NATESA.

Meetings are generally devoted to business matters, but technical topics are also featured. In any case, the formal close of most meetings signifies the beginning of a technical bull session. Realizing that members' wives were often involved directly in their husbands' businesses, the men of MARTS began inviting their women-folk to several dinner meetings about a year ago. The resulting increase in the number of members who managed to attend meetings was spectacular. (Other associations, please note!)

"MARTS News," a monthly that runs from 6 to 8 pages, edited by Helen S. Bessert, is the official publication. Besides being sent to all members, it goes to TV retail stores, jobbers, local TV stations, and prospective members. Circulation is about 600 copies. Advertising is accepted, and comes mostly from local distributors. The revenue thus derived is enough to cover printing and production costs, so that no subscription charges need be paid by readers. Technical and business articles are run or reprinted from other sources. The use of the publication as a sounding board for reader opinion has resulted in many useful ideas.

Affiliated with the National Alliance of Television and Electronic Service Associations, MARTS is planning to change its name to "TESA of Milwaukee," in line with the practice adopted by many NATESA affiliates. Its members are now talking about getting together with other Wisconsin groups to form a state-level association.

Social events include an annual mid-summer picnic (shop talk is forbidden!) and a Christmas party. Inviting local parts jobbers to the latter affair has proved useful in establishing better relations between independent service and distributors. —30—

Would you like us to feature your association here? Send in the coupon!

Service Editor  
RADIO & TV NEWS  
1 Park Avenue  
New York 16, New York

We want to tell you more about our association. Please send us your questionnaire.

Name of Association .....

Mailing Address .....

Name of President or Corresponding Sec'y .....



## Electrostatic Speakers (Continued from page 38)

will provide adequate frequency separation.

**Question 6.** *Electrostatic speakers operated from different amplifiers, or with different loudspeaker systems, seem to give quite inconsistent results, unpredictably at times. Why should this be?*

This brings to light a fact not often recognized. The electrostatic loudspeaker as an amplifier load sometimes interacts with the performance of the amplifier. A feedback amplifier may be measured and found to have a flat frequency response to well beyond the limits of audibility. Independently, a tweeter may also be measured and found to have a flat frequency response over its intended range. But when the two are put together, the arrangement may become unstable, so some high frequency, possibly about 12,000 cycles, becomes extremely over-accentuated. This is *not* due to the amplifier or the electrostatic loudspeaker, but the combination of *both*.

This particular amplifier, due to its feedback arrangement, does not give the same performance when feeding an electrostatic loudspeaker as it does when feeding the resistance load used for testing it. Another amplifier, with identical characteristics under the test condition with a resistance, will give just as good results with the electrostatic loudspeaker and there will be no over-accentuation of a high frequency.

This deficiency is not unique to electrostatic tweeters. The moving coil or dynamic types often possess appreciable inductance at the extreme high-frequency end. So with different feedback amplifiers, compression driver-type tweeters, which may also have quite a good frequency response, can also show peakiness at the high end.

This erratic behavior of feedback amplifiers results in some very confusing and conflicting results, until the cause is understood. Unfortunately the effect is not one that can be conveniently specified in terms of the performance of an amplifier, because the exact amount of inductance or capacitance, contributed by either kind of tweeter, varies from type to type.

The only way to find out whether this kind of thing will happen with the combination you contemplate is to try it. So we recommend that, before purchasing either kind of tweeter, you try it on the amplifier you have in mind, either by arranging a trial of the unit on your own amplifier at home, or by listening to it in the showroom *fed from an amplifier identical with the one you have at home*. Failure to observe this precaution may well result in ultimate disappointment with the performance of the added speaker.

## You get these *plus* features with STANCOR

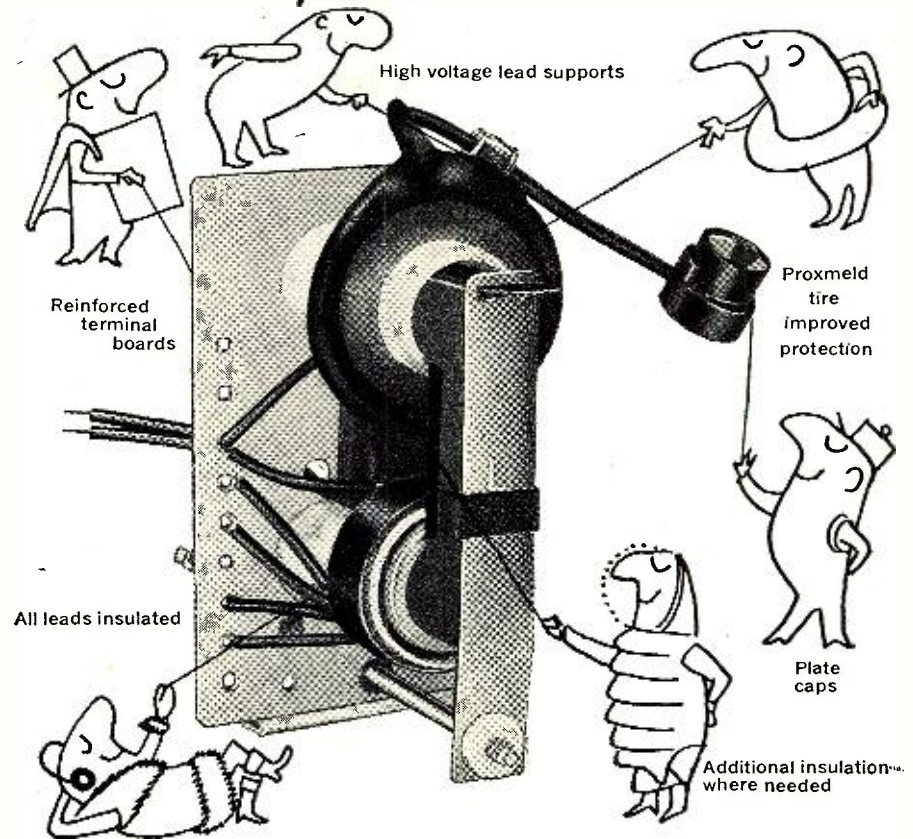

Stancor, the pioneer in the field of exact replacement flybacks, now goes one step further. The Stancor replacement represents an *improvement* over the original manufacturer's units. Additional features—like those above—are added when necessary to insure optimum performance. Stancor flybacks are engineered and improved replacements to help make your work more efficient and more reliable.

**FREE**—a new 100 page TV Replacement Guide with a brand-new format. Locates the replacement immediately—with or without the original part number. Models listed individually in numerical order. See your distributor or write us for your free copy.



## CHICAGO STANDARD TRANSFORMER CORPORATION

3505 Addison Street • Chicago 18, Illinois

Export Sales: Roburn Agencies, Inc. • 431 Greenwich Street • New York 13, N. Y.

### RADIO CONTROL!

For Models—FREE Send for FCC form 505 & Catalog "N"  
**R/C TRANSMITTER.**  
 Hi-Power  
**HAND HELD.**  
 Complete \$17.95 . . . . Kit **\$11.95**  
**RADIO CONTROL RECEIVER** 27 1/4 Mc. with Re-  
 lay, Tube & Acces. Wired. Tested only 3 oz. **\$8.61**  
**TUBES:** XFG1, RK61, 3A4, 1AG4 . . . Transistor .99  
**SIGMA 4F RELAY:** 8000 ohm \$4.25 . . . 6 Reed **14.95**  
**RELAYS:** 10 K ohm, 2 Ma DC or 110V AC SPDT  
 95¢ SPST 85¢; 12-24 Volts, 2 Make, 1 Break. .95  
**RELAY CONTROL UNIT:** Incl. Sensitive 10,000  
 ohm Sigma Relay (1 1/2 Ma) Thermal Bi-Metal  
 Strip Heating Element Hi Z Audio Choke, Mag-  
 net, Neon Lamp, Resistors, Capacitors. . . . .  
**2" METERS:** 0-1 Ma. \$3.65; 3 Ma. \$2.85; 150  
 MicroA \$3.95; 50 Ma \$1.85; RF 0-1/2 A. . . . .  
**HANDIE TALKIE CHASSIS:** Basic Transmitter &  
 Receiver. New With Dual Tube. . . . . **6.65**  
**DYNAMOTORS:** 12V/235V @ 75 Ma. \$2.95; 6V  
 150V @ 100 Ma. \$6.95; 6V/300V, 100 Ma. . . . . **9.95**  
**SOLDERING IRON** 99¢; Toy Motor Kit. . . . . **4.95**  
 Whip ANTENNA 32 ft. Sectional. . . . . **5.95**  
**GYRO ELECTRONICS CO.** 325-N CANAL ST.  
 NEW YORK 13, N. Y.

### Wholesale Only SELLING

Receivers, Transmitters, Radar, Special  
 Purpose Tubes, Relays, Meters, Switches,  
 Connectors, Rectifiers, Transformers, Mo-  
 tors & Generators, Wiring Cable, Instru-  
 ments and All Electronic Components.

### RADIO & ELECTRONIC SURPLUS

14000 BRUSH STREET  
 Detroit 3, Mich. TO 9-3403



# 3 REASONS WHY THEY'RE THE BEST ON THE MARKET!

## SPAULDING X-CB TV TOWERS

1. NO CONCRETE NECESSARY
2. COMPLETELY SELF-SUPPORTING
3. GO UP IN 90 MINUTES

No other TV antenna tower offers so much in the way of quality, appearance and easy installation as SPAULDING X-CB STRATO-TOWERS. Beaded channels, riveted construction and heavy galvanizing, plus exclusive cylinder base eliminate concrete and guy wires, assure fast, permanent erection. Insist on SPAULDING . . . be sure of all-ways better TV pictures!

U. S. Patent No. 2806560

**No. X44CB (ILLUSTRATED)**  
40 FT. HIGH LIST **\$79.95**  
OTHER MODELS FROM 8 FT. TO 64 FT.

HOW  
TOWER  
MOUNTS ON  
CYLINDER  
BASE

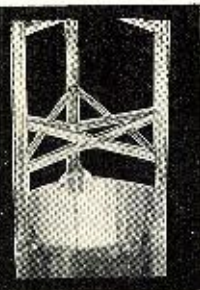

**WRITE**

today for complete literature and details on where to get Spaulding Strato-Towers for TV—Ham—Civil Defense—Industrial Communications.

**SPAULDING PRODUCTS COMPANY**

550 West Bamer Street Frankfort, Indiana  
IN CANADA: Delhi Metal Products Co., Delhi, Ontario

102

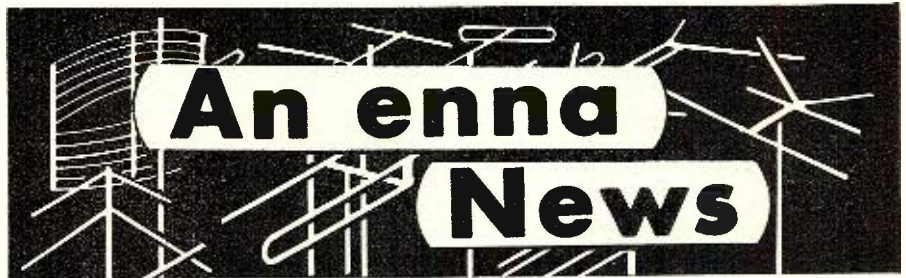

### "SIGNAL-MASTER" LEAD-IN

New Products Engineering & Manufacturing Co., 5305 Chicago Ave., Minneapolis, Minn. has released a permanent weatherproof TV lead-in line

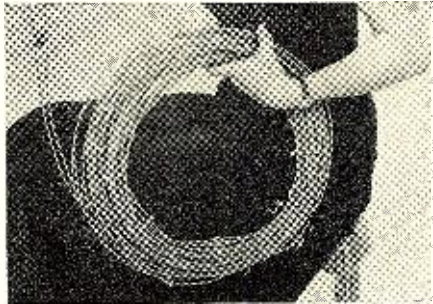

which has been especially designed for use in areas of high humidity and temperature extremes.

Known as "Signal Master" lead-in, in addition to being resistant to salt corrosion, the line is said to improve reception in fringe and far-fringe areas. The product is being merchandised in sealed cartons and in pre-cut lengths of assorted sizes, with factory prepared, sealed terminals on the antenna end to assure water tightness and to eliminate the possibility of galvanic action and corrosion at the antenna junction point.

Radio, TV, and electronic parts jobbers will handle this new lead-in.

### TWO ANTENNAS FROM HY-GAIN

Hy-Gain Antenna Products, 1135 North 22nd, Lincoln, Neb. is now marketing two new antenna systems for the amateur fraternity.

The triaxial gamma-match system is precalibrated with a coaxially formed reactance-cancelling capacitor built-in, providing a 1:1 s.w.r. on a three-band antenna system. Exceptional bandwidth maintains low s.w.r. over the entire band. A coax connector for 52-ohm feedline is included with the system.

The second unit is the gammamaxial gamma-match system designed for use with high-gain single-band beams. A precalibrated gamma-match assembly with coaxially formed reactance-cancelling capacitor built-in makes possible the 1:1 s.w.r. in a single-band beam. The coax connector for 52-ohm feed is supplied with the system.

### TRIO "WINGED" 88

Trio Manufacturing Co. of Griggsville, Ill. has just introduced its "Winged" 88 antenna, a "souped-up" version of the firm's "Sharpshooter" 88 conical-yagi unit.

The new antenna features a "wing"

director used in conjunction with a new T-match dipole. This combination is an exclusive feature of the new antenna and gives increased gain and sensitivity, according to the company.

The "wing" director is an integral part of the firm's "Zephyr" and "Color" series antennas. Single and two-bay models of the "Winged" 88 are being offered at the option of the user.

For full details on this or any of the other models in the firm's line, write the manufacturer direct.

### "ROCKET LINE" ANTENNAS

The Electronics Division of Van Norman Industries, Manchester, N. H. has

added three new units to its Nemco line of automotive antennas.

The new units are the "Atlas," "Jupiter" and "Sparrow." The first two are custom-made for front fender installation on the 1958 Chevrolet and the entire 1957-58 Chrysler line. The "Jupiter" is a concealed type, made in three sections which extend from 1½" to 54" with a 48" lead.

The "Atlas" can be installed on any flat surface. It, too, is made in three sections.

Top fender and cowl styling is incorporated in the "Sparrow" which can be mounted entirely from outside the vehicle. No tools are required for replacement. Its three sections extend to 57" with a 48" lead.

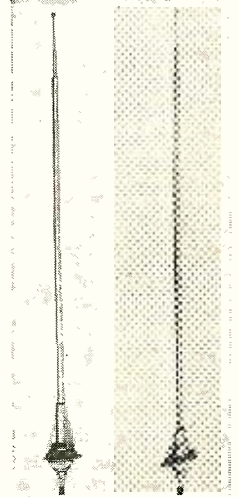

### RMS "DYNA WAVE"

Radio Merchandise Sales, Inc., 2016 Bronxdale Ave., New York 62, N. Y. has added the "Dyna Wave" to its line of power antennas.

The new unit is designed to provide maximum gain for color and black-and-white TV reception. Elements are cut for maximum gain on all low- and high-band channels, 2 through 13.

Weatherproof construction and low silhouette design to reduce wind drag help make the antenna impervious to the elements. Fully automatic snap-lock construction facilitates easy, rapid installation.

It is currently being offered single or stacked.

—50—  
**RADIO & TV NEWS**



## Your Business Telephone

(Continued from page 58)

an open telephone should never be left lying on a desk. A customer can easily hear all of the office or shop talk. She may think she is being talked about even though her problem was not being discussed.

Business promises are serious obligations. When a promise is made to a customer, it is a guarantee of definite performance. Care should be taken to avoid making a commitment for a technician to call at a specific time unless it is certain that he can be there at that time. Many fruitless calls are made where the customer is not at home at the time the technician called. A recent survey of a group of these calls revealed that, in most instances, the customer was under the impression that the technician was to have been there several hours before he actually arrived. A better planned system for routing calls and making promises would have saved the dealers money in lost time and mileage.

Many dealers complain that in their areas they are "forced" to handle a lot of charge business. Then they have trouble in collecting the accounts. In checking the practices prevalent in other types of service businesses in those areas, such as auto-repair shops and home-product maintenance organizations, it was found that they man-

age to maintain strictly C.O.D. businesses. The major difference was not in customer expectations but in dealer attitude toward charge and C.O.D. business.

Where a planned telephone answering pattern is used, charge accounts can be held to a minimum by incorporating the information that service calls are C.O.D. during the conversation with the customer. Some dealers start to close their conversations with customers with statements something like this:

"Of course, Mrs. Customer, we will be happy to send one of our technicians to repair your set. It will be *perfectly* all right for you to pay him when he finishes the job. There is a minimum service charge of — dollars. We do not charge extra for travel time. Of course, there will be a charge for any tubes or parts that are needed."

There are times, of course, when a customer will ask for an explanation of why service charges are C.O.D. Some dealers answer that by saying, "Mrs. Customer, by eliminating book-keeping we can keep the cost of our service to a minimum."

The entire service industry would benefit greatly from a planned campaign on the part of all dealers to improve their methods of handling customer telephone calls. It would be the logical first step in any national campaign to build public confidence in independent electronic service shops. And it would not cost a cent!

**COYNE**  
TRAINS YOU  
IN SPARE TIME  
AT HOME

**COYNE**  
QUALITY  
TRAINING  
AT LOWEST  
COST

# TELEVISION

## RADIO-COLOR TV

Only from famous COYNE do you get this modern up-to-the-minute TV Home Training. Easy to follow instructions—fully illustrated with 2150 photos and diagrams. Not an old Radio Course with Television tacked on. Includes *UHF* and *COLOR TV*. Personal guidance by Coyne Staff. *Practical Job Guides* to help you **EARN MONEY QUICKLY** IN A TV-RADIO SALES AND SERVICE BUSINESS—part time or full time. COSTS MUCH LESS—pay only for training—no costly "put together kits."

**SEND COUPON FOR FREE BOOK**

SEND COUPON BELOW for Free Book and full details including EASY PAYMENT PLAN. NO COST OR OBLIGATION—NO SALESMAN WILL CALL.



B. W. COYNE, JR. **COYNE** FOUNDED 1899  
PRES. **ELECTRICAL SCHOOL**

A TECHNICAL TRADE INSTITUTE OPERATED NOT FOR PROFIT  
500 S. Paulina Dept. A8-H6 Chicago 12, Illinois

**COYNE ELECTRICAL SCHOOL**  
Television Home Training Div.  
500 S. Paulina St., Chicago 12, Ill., Dept. A8-H6

Send FREE BOOK and details of your Television Home Training offer.

Name \_\_\_\_\_  
Address \_\_\_\_\_  
City \_\_\_\_\_ State \_\_\_\_\_

## LIQUIDATING MOBILE RADIO EQUIPMENT AT TREMENDOUS SAVINGS!

Manufactured by the famous LINK RADIO CORP.

One of the largest Police Depts. recently shifted the operating freq. of their call system. These Deluxe Link 2-way mobile systems were removed INTACT from their cars and new equipment installed. All tested in perfect operating condition, having undergone rigid tests and inspection after being removed. Most sets are in "like new" condition.

### FM MOBILE EQUIPT.—TYPE FMTR FOR 6 VOLT OPERATION

Complete assembly designed for mobile 2-way communication on the 30-10 mc. very-high frequency band. Consists of Radio Transmitter Type 35-UFM, Power Supply Type VPA-3A, Radio Receiver Type 11-UF, and accessories (less antenna assembly) for accomplishing an operating 2-way mobile communication system. Designed normally to derive all its primary energy from 6-volt, 3-cell lead storage battery. Radio Transmitter Type 35-UFM is a 35-watt (nominal output) freq.-modulated unit designed especially for mobile use. It utilizes the phase-shift method of obtaining the desired freq. deviation. This permits direct crystal control of the carrier freq. and a simple circuit design with no critical tuning adjustments. It is designed for a maximum freq. deviation of ± 15 kc in its operating range of 30 to 44 mc. carrier power considerably in excess of the rated wattage is available under normal operating conditions in mobile service. The transmitter is entirely self-contained and utilizes a dynamotor to convert the 6-volt input to high voltage for plate supply of the tubes. 7 tubes are included on the chassis, 6 of which are of the low drain receiving type. Tubes are: 7C7, 7A8, 7A8, 7C7, 7C7, 7G5, 807. Radio Receiver Type 11-UF is an 11-tube, crystal-controlled, single-freq., freq.-modulation superheterodyne receiver designed for the reception of freq.-modulated signals of the type generated by Mobile-Radio Transmitter Type 35-UFM and fixed station transmitters. The receiver utilizes 11 tubes in a multiple-superheterodyne circuit. Tubes are: 7AG7, 7AG7, 7AG7, 7AG7, 7S7, 7C7, 7AG7, 7AG7, 7F7, 7B5, 7AG. Receiver Power Supply Type VPA-3A is a synchronous vibrator "B" supply designed for use with the 11-UF receiver. It incorporates the most efficient and low-lived vibrator and circuit available, and affords a very reliable and economical method of obtaining "B" voltages. Complete system \$99.50 (as described above) with instruction manual. PMC Crystals & Antenna for above avail.—price on request. PMC Kits & 12-volt Conversion Kits avail. from manufacturer.

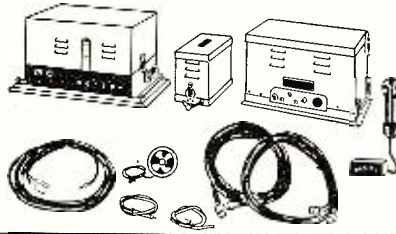

### Mobile Components

- Military Microphones.
- W.E. Type Handsets with push-to-talk switch.
- W.E. G3AW3 Handsets.
- 4 Wire Coil Kords
- Sammo Flat Pak Dynamotors 12 V IN. 600 DC @ 240 MILL OUT.
- Universal 6/12V Vibrators.
- FMTR Utility Cabinets.
- HS-16 Springs for Antenna Mounts.
- 6 V & 12 V Vibrator Transformers.
- Replacement Coils for Link Equip.
- 12 V Conversion Kits for all Link Equip.
- 12 V Dynamotors, 625 VDC @ 225 MA OUT. Available from Mtr.

### SENSATIONAL SALE!

#### ARC-5/R-28 2 METER RECEIVER

Excellent Condition **17.95**

T-18/ARC-5 TRANS. 2.1 to 3 mc. new \$19.95

T-23/ARC-5 TRANS. 100 to 136 mc. good used \$13.95

### COMMAND EQUIPMENT

- BC-454 Receiver, 3-6 mc. good used.....\$8.29
- BC-455 Modulator, new.....\$1.95
- BC-458 Trans., 3-3 mc to 7 mc. good used.....\$5.75
- BC-696 Trans., 3-4 mc. good used.....\$6.95
- BC-602 Control head for SCR-522, new.....\$1.29
- Plug for above Command Sets, PL-152-A or PL-156-A.....\$0.55

### VOLT-OHM-METER

1000 OHM per VOLT 3" G. E. METER  
DC-Volts: 3-30-300-600-1800 OHM:  
1-10-100-1000 X 1000 with Test Leads & Battery.

Case 3" x 3" x 6".....\$8.49



### FM RADIO EQUIPMENT TYPE 2210

6-VOLT OPERATION

Designed for 2-way communication in mobile radio systems operating in the 152-152 mc. very-high-freq. band. In most cases it will be used in mobile units and derive its power from the 6-volt vehicular electrical system. Write for details, description. Complete with all accessories & instruction manual, ready for \$129.50 operation. Used, checked out.....\$169.50  
Crystals, 12-volt Conversion Kit & Antennas available—price on request.

### FM RADIO EQUIPMENT TYPE 2365

6-VOLT OPERATION

Same specs. as Type 2210 above, except operates in 25-50 mc very-high-freq. band. Used, checked out.....\$99.50  
Crystals, 12-volt Conversion Kit & Antennas available—price on request.

### BC-221 Frequency Meter

Real Value! QUANTITY IS LIMITED—so first come, first served. They are just like new, with original calibration charts. Range 125-20,000 KC with crystal check points in all ranges. Complete with crystal and tubes.....\$139.50  
MODULATED TYPE.....\$169.50  
Power Supply.....189.50  
These Frequency Meters are factory tested, checked for frequency alignment and GUARANTEED.



### BC-456 MODULATOR

Size: 8" w., 10" l., 6 1/4" h. (mounting centers 7 1/2" x 9")  
Tube complement: YR-150, 12J3 speech amplifier, 962 modulator. Uses: Grid modulator for transmitters up to 150 watts, or can plate modulate small rigs up to 35 watts. Also can be used as a paging amplifier, audio amplifier (by changing to output transformer) etc. Contains valuable parts as transformers, tubes, relay, resistors and by pass condensers. Voltage requirements: 12.6 v.—2.5 amps filament, 150 v. (for screen & speech amplifier). 300-400 v. plate voltage. \$1.95 Each.....\$1.95

### J-38 KEY

Mounted on black bakelite base. 4 1/4" x 3", easily attached to operating desk. Has jumper strip, binding posts and circuit closing switch, full adjustable, 1/16" solid silver keying contacts. Metal parts are cadmium-plated. New \$1.29  
J-45 Key with metal knee band. Brand New.....\$2.95



### OUR RETAIL DEPARTMENT IS OPEN ALL DAY SATURDAYS

Immediate delivery. Include 25% deposit with order—balance C.O.D. 50¢ HANDLING CHARGE ON ALL ORDERS UNDER \$5.00. All shipments F.O.B. our warehouse, N.Y.C.

## PLATT ELECTRONICS CORP.

20 MURRAY ST., NEW YORK 7, N. Y.

Telephone: COrtlandt 7-2575

### 6V FMTR EQUIPMENT

Less tubes and crystals. With cables and controls. Used, as is.....\$59.50

### SPECIAL!

20 LBS. of ASSORTED RADIO PARTS

A terrific buy at only

**\$2.79**







## FLYBACKS UNLIMITED!

**TRIAD MAKES A COMPLETE LINE** of replacement flybacks. They fit mechanically, fit electrically, and operate as good as—or better than—original equipment. Be sure you receive the correct replacement—specify TRIAD. Ask your distributor, or write for the new 132-page Triad Replacement Catalog & Correct Replacement Guide TV-58.

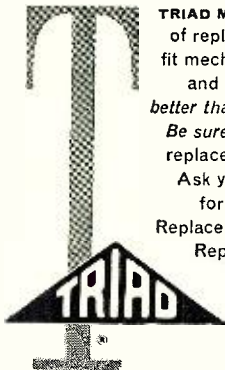

**TRIAD TRANSFORMER CORPORATION**  
4055 REDWOOD AVE. | 812 E. STATE STREET  
VENICE, CALIFORNIA | HUNTINGTON, INDIANA

A SUBSIDIARY OF LITTON INDUSTRIES

# Certified RECORD REVUE

By **BERT WHYTE**

**T**HE stereo disc and its ramifications continue to make the news in the record world. All the cartridge companies are now busily tooling for the "45-45" stereo disc system and by the time you read this, quite a few more will have reached the market. While the major record companies at the time of writing were still not releasing any stereo discs, the rumors grew more persistent and stronger that the "target date" for the majors would be at the National Association of Music Merchants convention in Chicago in July.

Meanwhile the experiments continue and I have had a chance to hear some of the first symphonic stereo discs and they were quite good. From *Victor*, I heard the Rachmaninoff 1st Piano Concerto with Byron Janis and the Chicago Symphony and "LaValle in Hi-Fi." There was not any really significant distortion except towards the very inner grooves, and dynamic range was well preserved; the level on these discs seemed to be almost the same as on monaural, which shows some progress has been made in cutting techniques, since some of the early stereo discs were quite a few db down in level as compared to their monaural counterparts.

As in most things hi-fi, the results from the stereo discs vary according to the type and quality of equipment that is used. I can tell you that there is just as much difference between stereo cartridges of different quality and price as there is in the monaural versions.

This compatibility business has been in for more discussion and now it is pretty well accepted by all the record companies that you can't successfully play a standard "45-45" stereo disc with a regular 1 mil monaural pickup. Most companies are therefore planning on a double inventory, at least for the present. Elsewhere in this issue you will find a story on an attempt by *Columbia* to so modify the "45-45" system that it is compatible with monaural cartridges. Most of the other companies seemed to reject the idea on the grounds that the result was "neither good monaural nor good stereo." In spite of this *Columbia* is continuing its experiments and it will be interesting to see what they come up with.

Sorry the column has to be short this month, I'll try to give you a bonanza in the next issue.

### **PROKOFIEV** VIOLIN CONCERTO #1

Isaac Stern, violinist, with New York Philharmonic Orchestra conducted by Dimitri Mitropoulos.

### VIOLIN CONCERTO #2

Isaac Stern, violinist, with New York Philharmonic Orchestra conducted by Leonard Bernstein. *Columbia* ML5243. Price \$3.98.

One of *Columbia's* best violin concerto discs in a long time. Isaac Stern is in tremendous form, displaying a ravishingly beautiful tone and dazzling us with his technical mastery. The Scherzo in the first concerto is an astonishing exercise in violin gymnastics. With sympathetic accompaniments from Mitropoulos and Bernstein and the exceptionally clean, well-balanced sound, this is a disc well worth owning.

### **STRAUSS, RICHARD** TILL EULENSPIEGEL'S MERRY PRANKS DEATH AND TRANSFIGURATION DON JUAN

Cleveland Orchestra conducted by George Szell. Epic LC 3439. Price \$3.98.

Even if the performance were not as good as it is, this would be a terrific bargain, well worth considering. To my knowledge this is the first time anyone has managed to squeeze three Strauss tone poems onto one disc. Szell is very good in the "Transfiguration" and "Don Juan," just a bit humorless in "Eulenspiegel." The sound is quite clean and spacious, with little distortion evident from the squeezing in of so much music. I must warn you to inspect your copy carefully if you intend to purchase this as I was quite exasperated with a bad off-center spindle hole, or "swinger" as they are called in the trade. Probably not in all copies but you had better take a look.

### **BEETHOVEN** VARIATIONS ON A THEME BY DIABELLI

Rudolph Serkin, pianist. *Columbia* ML5246. Price \$3.98.

The diabolically difficult Diabelli Variations was one of the last great works of Beethoven. The degree of virtuosity called for in these 33 variations has been the despair of more than one pianist. Not so for the formidable talents of Serkin who makes of this work a pianistic *tour-de-force*. His phrasing and dynamics are nigh perfect, only a slight hardness of tone (which is probably heightened by the very close-up, somewhat dry resonance of the sound) marring the disc. A minor point which should not deter you.

### **MARCH TIME** Eastman Symphonic Wind Ensemble conducted by Frederick Fennell. Mercury MG50170. Price \$4.98.

Another magnificent recording of marches performed with the by-now-almost-legendary Eastman group and its diminutive dynamo of a conductor, Fred Fennell. All the

The opinions expressed in this column are those of the reviewer and do not necessarily reflect the views or opinions of the editors or the publishers of this magazine.



familiar ingredients are here. The razor-sharp precision of the attacks and ritards, the big sonorous fullness of tone, the over-all splendor of the musicianship. One side of the disc is devoted to music by the great Edwin Franko Goldman, the other to various other composers for band. It includes the "Guadalcanal March" from Richard Rodgers' epic "Victory At Sea." If such a thing is possible, the sound here is even better than the notable discs which have preceded this in this series. The brass is big and bright, and the percussion is of the king-sized variety that sends hi-fi pulses racing! For a stunning demonstration of the quality of sound that can be engraved on a disc these days, listen to the "Children's March," and especially note the fantastic finale. This is another "must" for band fans.

**BRUCKNER**  
**SYMPHONY #4**  
**(ORIGINAL VERSION)**  
 Symphony Orchestra of the Bavarian Radio conducted by Eugen Jochum.  
**SYMPHONY #7**  
**(ORIGINAL VERSION)**  
 Berlin Philharmonic Orchestra conducted by Eugen Jochum. Decca DXE-146. Price \$14.97. Three discs.

This is an album which will be greeted with delight by devoted Brucknerites. For one thing, the original versions of the works are used. For another, Jochum is inspired in his readings and gives solid evidence that he must be considered among the premier exponents of Bruckner's music. He has hit here just the right tempi . . . and this combined with his intelligent phrasing and dynamics gives the scores a nice even flow and progression. The sound deserves comment too, being quite clean and with the superlative acoustic balance which is a trademark of *Deutsches Grammophon*. Not a "hi-fi" sound in the American sense, but nonetheless "highly faithful" to the music and the hall in which it was recorded. Since these are Bruckner's two most easily assimilated scores, those who are in an investigative mood will find these discs an excellent starting point.

**BRETON**  
**ANDALUSIAN SCENES**  
 Gran Orquesta Sinfonica conducted by Ataúlfo Argenta. London LL-1701. Price \$4.98.

This is Volume Six in the "Music of Spain" series *London* started with such promise with Ataúlfo Argenta. At the time of this fine young conductor's tragic death a few months ago, *London* had completed about 12 volumes. These are now being released and they form a fitting memorial to the considerable talents of Argenta. These "Andalusian Scenes" contain some of the most colorful music to be found in this series and will have a very general appeal, rather than to a predominantly Spanish-speaking audience. Needless to say, "color" in Spanish music means a feast of hi-fi sound and such is the case here. The over-all sound is clean, with broad dynamics and a fine liveness due to the expert "miking."

**BRAHMS**  
**VARIATIONS ON A THEME BY HAYDN**  
**HUNGARIAN DANCES NOS. 21, 1, 2, 7, 5, 6, 11**

London Symphony Orchestra conducted by Antal Dorati. Mercury MG50154. Price \$4.98.

It takes a conductor of real talent to perform an oft-beaten warhorse like the "Hungarian Dances" and make it something exciting. This is just what Dorati has accomplished here, so don't turn up your hi-fi noses too quickly! No little aid in the job was

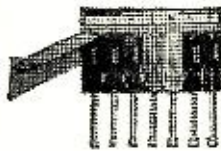

. . . Superbly made and designed for Radio, T.V. and Electronic Technicians. See your Distributor . . . only one quality . . . the finest — whether you choose individual items or the handy kits . . .

*Use the Tools the Professionals use!*

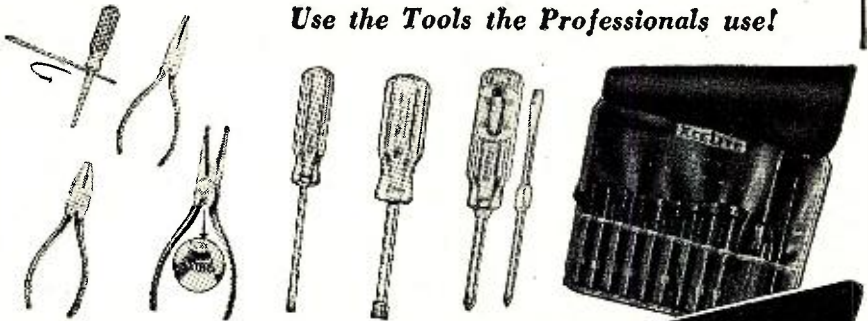

**XCELITE, INCORPORATED**  
 ORCHARD PARK, NEW YORK  
 Canada: Charles W. Pointon, Ltd., Toronto

**XCELITE**  
*Quality Hand Tools*  
 PREFERRED BY THE EXPERTS

## MOBILE-RADIO MAINTENANCE

**CAN MEAN**

**A BETTER HOME . . .  
 A BIGGER CAR . . .  
 AND MONEY  
 IN THE BANK!**



It's a rapidly growing industry that practically guarantees a high, regular income to qualified *independent* servicemen. Thousands of new transmitters are licensed each month — and must have regular maintenance . . . plus periodic FCC checks. The usual method of payment is a service contract which provides for retainer fees.

To learn about rates . . . typical contracts . . . and take home pay . . . send for the free booklet "HOW TO MAKE MONEY IN MOBILE-RADIO MAINTENANCE".

*In addition to your present test equipment you'll want these Lampkin meters.*



LAMPKIN 105-B  
 FREQUENCY METER  
 RANGE 0.1 TO 175 MC.  
 AND UP  
 PRICE \$220.00



LAMPKIN 205-A FM  
 MODULATION METER  
 RANGE 25 TO 500 MC.  
 PRICE \$240.00

**MAIL THE COUPON TODAY!**

LAMPKIN LABORATORIES, INC.  
 MFM Division, Bradenton, Florida

At no obligation, please send me free booklet, technical data on Lampkin meters, and time-payment plan details.

Name \_\_\_\_\_  
 Address \_\_\_\_\_  
 City \_\_\_\_\_ State \_\_\_\_\_

**TIME PAYMENT PLAN AVAILABLE**

**LAMPKIN LABORATORIES, INC.**  
 MFM Division  
 BRADENTON, FLORIDA



# "ONE DOLLAR" buys

As much as \$15 worth — Everything Brand New and sold to you with a money back guarantee.

**DEDUCT 10% ON ANY ORDER OF \$10 OR OVER**  
**Plus a FREE SURPRISE PACKAGE**

- 100 - ASSORTED FUSES popular sizes.....\$1
- 100 - ASST. 1/2 WATT RESISTORS some 5% \$1
- 70 - ASSORTED 1 WATT RESISTORS.....\$1
- 35 - ASSORTED 2 WATT RESISTORS.....\$1
- 50 - ASST. TUBULAR CONDENSERS.....\$1
- 10 - 6' ELECTRIC LINE CORDS with plugs.....\$1
- 5 - TV CHEATER CORDS with both Plugs....\$1
- 4 - 50' SPOOLS HOOK-UP WIRE 4 colors...\$1
- 50 - STRIPS ASST. SPAGHETTI best sizes...\$1
- 100 - ASST. RUBBER GROMMETS best sizes...\$1
- 100' - TWIN LEAD-IN WIRE 300Ω heavy duty...\$1
- 50' - FLAT 4-CONDUCT. WIRE many purposes...\$1
- 25' - INSULATED SHIELDED WIRE.....\$1
- 1 - \$7 INDOOR TV ANTENNA hi-gain 3 section \$1
- 20 - ASST. TV KNOBS, ESCUTCHEONS, Etc. \$1
- 3 - ASST. TOGGLE SWITCHES spst. dpdt. etc. \$1
- 6 - ASST. SLIDE SWITCHES sst. dpdt. etc. \$1
- 4 - BAKELITE KNIFE SWITCHES dpdt.....\$1
- 15 - ASST. ROTARY SWITCHES \$15 worth...\$1
- 100' - FINEST NYLON DIAL CORD best size...\$1
- 200 - SELF TAPPING SCREWS #8 x 1/2".....\$1
- 35 - ASST. RADIO KNOBS screw and push-on...\$1
- 100 - KNOB SPRINGS standard size 3/8" x 1/2" \$1
- 100 - ASSORTED KNOB SET-SCREWS.....\$1
- 25 - ASSORTED CLOCK RADIO KNOBS.....\$1
- 400 - ASST. H'DWARE screws, nuts, rivets, etc. \$1
- 50 - ASST. SOCKETS octal, noval and miniature \$1
- 20 - ASSORTED TUBE SHIELDS best sizes...\$1
- 50 - ASST. MICA CONDENSERS some in 5% \$1
- 50 - ASST. CERAMIC CONDENSERS.....\$1
- 10 - ASST. VOLUME CONTROLS less switch...\$1
- 5 - ASST. VOLUME CONTROLS with switch...\$1
- 100 - VOLUME CONTROL HEX NUTS.....\$1
- 20 - ASST. PILOT LIGHTS popular types...\$1
- 10 - PILOT LIGHT SKTS. bayonet type, wired...\$1
- 50 - ASST. TERMINAL STRIPS 1, 2, 3, 4 lug...\$1
- 10 - ASST. RADIO ELECTRO. CONDENSERS...\$1
- 5 - ASST. TV ELECTROLYTIC CONDENSERS...\$1
- 15 - ASST. TV COILS s.v.c. peaking, width, etc. \$1
- 25 - ASST. MICA TRIMMER CONDENSERS...\$1
- 50 - TUBULAR CONDENSERS .001-600v.....\$1
- 15 - TUBULAR CONDENSERS .047-600v.....\$1
- 50 - TUBULAR CONDENSERS .01-400v.....\$1
- 2 - ELECTROLYTIC COND. 40/40-450v.....\$1
- 2 - ELECTROLYTIC COND. 40/10/10-450v...\$1
- 30 - FP CONDENSER MOUNTING WAFERS...\$1
- 3 - ELECTROLYTIC COND. 80-450v.....\$1
- 3 - ELECTROLYTIC COND. 50/30-150v.....\$1
- 15 - TUBULAR CONDENSERS .015-1600v...\$1
- 10 - HV TUBULAR CONDENSERS .006-1600v...\$1
- 10 - HV TUBULAR CONDENSERS .001-6000v...\$1
- 10 - HV TUBULAR CONDENSERS .005-6000v...\$1
- 35 - MICA COND. 20-100 mmf & 15-270 mmf...\$1
- 35 - MICA COND. 20-470 mmf & 15-680 mmf...\$1
- 35 - MICA COND. 20-820 mmf & 15-1000 mmf...\$1
- 35 - CERAMIC COND. 20-5 mmf & 15-10 mmf...\$1
- 35 - CERAMIC COND. 20-25 mmf & 15-47 mmf...\$1
- 35 - CERAMIC COND. 20-56 mmf & 15-83 mmf...\$1
- 35 - CERAMIC COND. 20-100 mmf & 15-150 mmf...\$1
- 35 - CERAMIC COND. 20-270 mmf & 15-470 mmf...\$1
- 35 - CERAMIC COND. 20-1000 mmf & 15-1500 mmf...\$1
- 35 - CERAMIC COND. 20-2000 mmf & 15-5000 mmf...\$1
- 50 - 100Ω 1/2 WATT RESISTORS 5%.....\$1
- 75 - 470KΩ 1/2 WATT RESISTORS 10%.....\$1
- 50 - 15KΩ 1 WATT RESISTORS 10%.....\$1
- 50 - 470KΩ 1 WATT RESISTORS 10%.....\$1
- 25 - 22Ω 2 WATT RESISTORS 10%.....\$1
- 25 - 100KΩ 2 WATT RESISTORS 10%.....\$1
- 10 - ASST. WIREW'ND RES. 5, 10, 20 watt...\$1
- 3 - AUDIO OUTPUT TRANS. 50L6 type.....\$1
- 3 - AUDIO OUTPUT TRANS. 6K6 or 6V6 type...\$1
- 3 - I.F. COIL TRANSFORMERS 456 kc.....\$1
- 3 - I.F. COIL TRANSFORMERS 10.7 mc FM...\$1
- 4 - OVAL LOOP ANTENNAS ass't hi-gain types \$1
- 3 - LOOPSTICK ANT. new ferrite adjustable...\$1
- 12 - 1/2 RADIO OSCILLATOR COILS 456 kc...\$1
- 3 - 1/2 MEG VOLUME CONTROLS with switch...\$1
- 5 - 50K VOLUME CONTROLS less switch...\$1
- 10 - SURE GRIP ALLIGATOR CLIPS.....\$1
- 1 - GOLD GRILLE CLOTH 14"x14" or 12"x18" \$1
- 1 - 5" PM SPEAKER alnico #5 magnet.....\$1
- 5 - SETS SPEAKER PLUGS wired.....\$1
- 10 - SETS PHONO PLUGS and PIN JACKS...\$1
- 2 - \$2.50 SAPPHIRE NEEDLES 4000 playings...\$1
- 5 - DIODE CRYSTALS 2-IN21 2-IN23 1-IN64 \$1
- 2 - SELENIUM RECTIFIERS 1-65 ma & 1-150 ma \$1
- 1 - TV VERT. OUTPUT TRANS. 10 to 1 ratio...\$1
- 5 - TV CRT. SOCKETS with 18" leads.....\$1
- 5 - HI-VOLT. ANODE LEADS with 18" leads...\$1
- 1 - TV RATIO DETECTOR TRANS. 4.5 mc...\$1
- 1 - SET TV KNOBS standard type incl. decals...\$1
- 1 - LB SPOOL ROSIN CORE SOLDER 40/60...\$1
- 6 - SPIN TIGHT SOCKET SET 3/16" to 7/16" \$1
- 3 - TV ALIGNMENT TOOLS 5", 7", 12".....\$1
- \$15 - "JACKPOT" TELEVISION PARTS.....\$1

HANDY WAY TO ORDER—Simply tear out advertisement and pencil mark items wanted (X in square) is sufficient; enclose with money order or check. You will receive a new copy of this ad for re-orders.

ON SMALL ORDERS—Include stamps for postage, excess will be refunded. Larger orders shipped express collect.

**BROOKS RADIO & TV CORP.**  
 84 Vesey St., Dept. B, New York 7, N. Y.

the magnificent sound that was captured. It is certainly safe to say that these dances have never been heard in such crisp, clean, ultra-live accents. The Brahms "Variations" is given a brisk, nicely modeled performance, equal or superior to any previous recording. Here too, the felicitous sound greatly aids in lending an aura of "on-the-spot" presence.

## THE SOUL OF HAITI

Jean Vincent, vocalist, with orchestra conducted by Alberto Socarras. Vanguard VRS9015. Price \$4.98.

This is a most unusual and extraordinary recording, documenting much of the music indigenous to Haiti and yet obviously derived from half-forgotten tribal chants and music of African heritage. This fellow Vincent has an amazing range and facility with his voice and in combination with the orchestra there are many weirdly wonderful sounds. There are work songs, love songs, war songs, and many others. The sound is wonderful... very clean and bright, with some very hi-fi drum sounds. One of the most appealing and yet puzzling things in the record is the ever-present sound of birds. Their song is beautiful and very clean and almost seems to perfectly counterpoint the vocal sections. But for the life of me, I can't tell whether they are real birds or clever imitations! You really should hear this... the "birds" alone are worth the price of the record!

## RIMSKY-KORSAKOV SCHEHERAZADE

Vienna State Opera Orchestra conducted by Hermann Scherchen. Westminster XWN18660. Price \$4.98.

Westminster had one of the most hi-fi "Scheherazades" in the LP catalogue when some years back Argeo Quadri recorded the work. Now with the same orchestra, we have Westminster's highly talented Dr. Scherchen at the conductorial helm and the results both musically and in terms of hi-fi sound are even more spectacular. Scherchen is steady and unflagging in his tempi and the work is propelled along at a faster pace than obtains with most conductors, but this poor tired pot-

boiler of a piece can do with a few cracks of the whip. Certainly it never lacks for excitement and drive, and at the same time, Scherchen knows how to extract the maximum value from the lyrical sections. The sound is pristine in its cleanness and crisp definition. The dynamics are properly wide and the acoustics have just the right spaciousness for maximum liveliness with a minimum of "reverberation blur."

## WINIFRED ATWELL PLAYS GERSHWIN

Winifred Atwell, pianist, with Ted Heath and his orchestra. London LL1749. Price \$4.98.

A sensational record this... on one side Miss Atwell and Ted Heath's orchestra give us one of the most unorthodox... and interesting... performances of the "Rhapsody in Blue." The other side is devoted to some Gershwin songs for piano with rhythm accompaniment. The "Rhapsody" is about as jazzy as you can make it, Miss Atwell's performance modeled on a fast upbeat style and Heath's men riding along with typical big band and jazz embellishments. The sound is very high level and if you start the record at a fairly good level, the opening clarinet in the "Rhapsody" will startle you with its room presence!

## REK-O-KUT CONTEST

A TRIP to the Brussels World's Fair will be the top prize in the nationwide dealer and consumer contest being sponsored by Rek-O-Kut Company, Inc. The dealer stage of the contest offers various prizes for effective window displays featuring the firm's arms, turntables, and other components. The consumer phase is designed to attract potential customers who do not now own component hi-fi equipment. For details on this contest, which winds up in July, see the firm's ad in this issue.

The "fingerprints" of an unknown chemical mixture are examined by engineers of International Telephone and Telegraph Corp., developers of an automatic electronic spectroanalyzer. Engineers Ronald Taplin (left) and Mortimer Rogoff examine a punched paper tape that records the absorbance of infrared (heat) waves, a quality as unique to chemicals as fingerprints to humans. The tape is inserted in the analyzer which computes the constituents. The electronic instrument is to be used by Sloan-Kettering Institute for Cancer Research for hormone analysis.

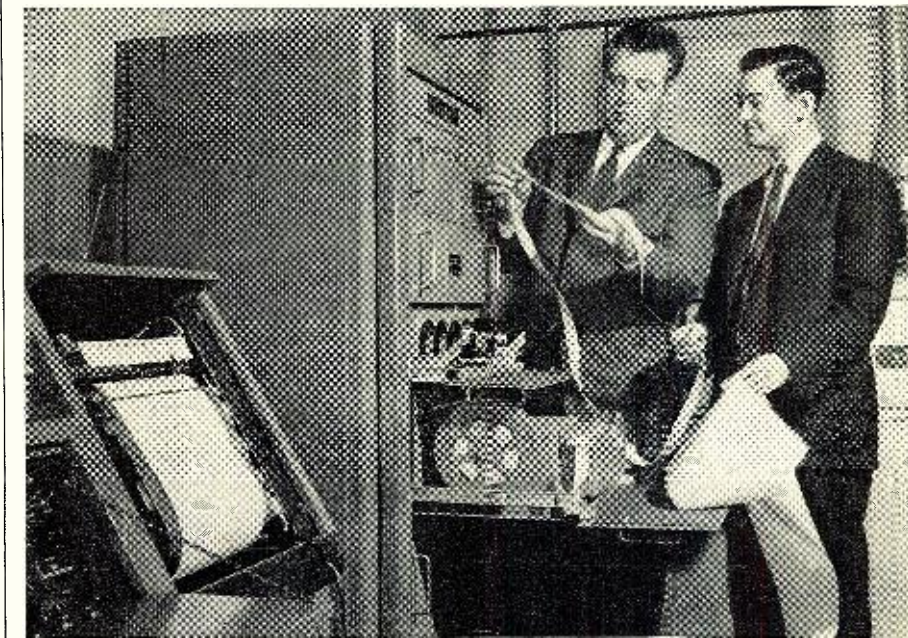



# Improved Sine-To-Square-Wave Adapter

By RUFUS P. TURNER

A SINE-TO-SQUARE wave adapter provides a simple means of converting the output of an audio signal generator into square waves for audio testing. However, most adapters built by experimenters use diode clipper circuits which produce only "squares" waves having badly slanting sides. Beyond about 5 kc., most of these devices do not operate very well.

Somewhat better operation has been obtained with the transistorized square-wave generators which employ multi-vibrator circuits. But these devices are not adapters and are connected to the sine-wave generator only for purposes of synchronization. They cannot be operated over a wide frequency range without switching in different values of capacitors and resistors.

The improved adapter circuit shown in Fig. 1 converts sine waves into good square waves over the frequency range from 20 cycles to 300 kc. The rise and fall times of the square wave are very steep and the peaks flat. Two inexpensive transistors are employed. (General Electric Type 2N168A.) The adapter is operated directly from the output of an audio signal generator or other sine-wave oscillator and has no controls of its own to adjust. The amplitude of the sine-wave input signal may be a maximum of 0.4 volt r.m.s. The corresponding amplitude of the square-wave output signal will be up to 1 volt peak. The square-wave amplitude is controlled by adjusting the output attenuator of the sine-wave generator.

A simple Schmitt trigger circuit is employed. The stages are direct-coupled, the collector of transistor V<sub>1</sub> being connected to the base of V<sub>2</sub>. Feedback is provided by the common emitter coupling resistor, R<sub>2</sub>. All resistors are 1/2-watt carbon. For compactness, capacitors C<sub>1</sub> and C<sub>2</sub> may be of the miniature metallized tubular type.

The circuit draws only 1.4 milliamperes d.c. The 1 1/2-volt battery, B<sub>1</sub>, may therefore be a penlite cell.

Circuit diagram of transistorized adapter.

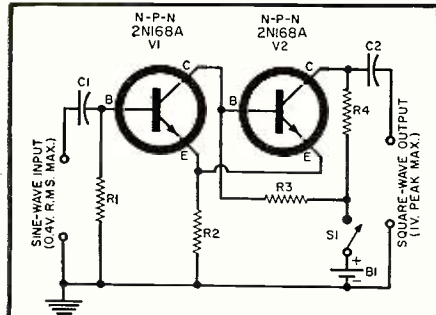

- R<sub>1</sub>—1200 ohm, 1/2 w. carbon res.
- R<sub>2</sub>—56 ohm, 1/2 w. carbon res.
- R<sub>3</sub>—2200 ohm, 1/2 w. carbon res.
- R<sub>4</sub>—220 ohm, 1/2 w. carbon res.
- C<sub>1</sub>—1 μfd., 200 v. miniature metallized tubular capacitor
- C<sub>2</sub>—1 μfd., 200 v. miniature metallized tubular capacitor
- S<sub>1</sub>—S.p.s.t. switch
- B<sub>1</sub>—1 1/2 volt penlite cell
- V<sub>1</sub>, V<sub>2</sub>—"n-p-n" transistor (General Electric 2N168A)

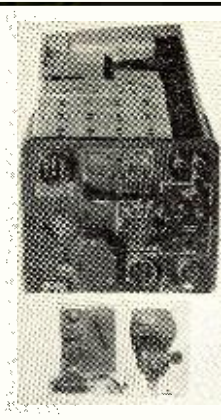

# ALL BAND RECIVER

190 To 9050 KC

AIRCRAFT • WEATHER • BROADCAST  
MARINE • FOREIGN • MOBILE  
AMATEUR—40-75-80 & 160 METERS

NAVY ARB/CRV 46151. Four Band, Six Tube Superhet—Local and Remote Tuning and Band Change, Illuminated Dial, Sharp and Broad Tuning, AVC, CW, Provisions for operation of DU-1 Loop. Complete with Tubes: 1/12SA7, 1/12A6, 4/12SF7; & 24 Volt Dynamotor. Size: 8" x 7" x 16". Wt.: 26 lbs. Conversion for 12 Volt or 115 V 60 cycle available. Price—Used **\$18.95**

Above—Converted to 12 Volt, with Dynamotor (No Electric Band Change) **\$26.95**

Conversion for 115 Volt 60 cycle with Spin Dial, Phone Jack, CW, Vol. Control, On & Off Switch—all on front panel Kit of Parts, with instructions. **\$10.00**

Conversion—as above—for 12 Volt DC Kit of Parts with Dynamotor. **\$10.00**

Remote Control Box \$2.00 Remote Control Head \$2.00  
Cable, with Plugs... 2.75 Remote Control Shaft 1.50  
PLUGS Only for Receiver or Control Box... Each: \$1.00  
Tuning Knob—for large splined shaft... \$1.00  
T-Shaft Adapter for remote & local tuning... 1.50  
New Spin Knob for converting Tuning direct... 1.00

## THE WORLD'S FINEST SURPLUS BARGAINS!

FOR DETAILS ON ITEMS LISTED BELOW—AND MANY OTHERS... **Send for New Catalog #M-58**

### RECEIVERS:

- BC-3050 FM—30 to 50 MC—10 MC Spread. New: \$29.95
- BC-603 FM—20 to 27.9 MC—Used: \$14.95. New: 19.95
- BC-683 FM—27 to 38.9 MC—Used: \$24.95. New: 29.95
- Link FM R-11UF/ED-3—30 to 40 MC... New: 34.95
- BC-229/429—201 to 398 MC; 2500 to 7700 KC. U: 6.95
- BC-733 Localizer (Satellite) less tubes & crystal... Used: 4.95
- BC-357 Marker Beacon—75 MC—U: \$39.95. N: 5.95
- R-4/ARR-2—234 to 258 MC... Used: 6.95
- RA-10 FA—Complete—2 to 10 MC; 150-400 KC... Used: 29.95
- RA-10 DA—Complete—2 to 10 MC & 150-1100 KC... Used: 34.95
- CRW-2—Fixed Frequency—53 to 88 MC... New: 6.95

### TRANSMITTERS:

- BC-230/430—2500 to 7700 KC... Used: \$ 8.95
- Nav/Command—2.1 to 3 MC—Used: \$7.95. New: 9.95
- BC-457—4 to 5.3 MC... Used: 4.95
- BC-458—5.3 to 7 MC... Used: 4.95
- Nav/BC-459—7 to 9 MC... Used: 7.95
- BC-1158—6 Meters—53.3 to 95 MC—U: \$29.95. N: 39.95
- TA-12—20-40-80 Meters... Used: 24.95
- BC-604 FM—20 to 27.9 MC—Used: \$14.95. New: 19.95
- BC-684 FM—27 to 39.1 MC—Used: \$14.95. New: 19.95
- BC-924 FM—27 to 39.1 MC—Used: \$14.95. New: 19.95

### TRANSMITTER—RECEIVERS:

- Raytheon FM—150 to 172 MC... Used: \$59.50
- SCR-522—100 to 156 MC AM... Used: 29.95
- BC-659 FM—27 to 38.9 MC... Used: 14.95
- BC-620 FM—20 to 27.9 MC—New: \$9.95. Used: 6.95
- BC-1335 FM—27 to 38.9 MC—W/Pow. Sup... U: 24.95
- BC-500 FM—20 to 27.9 MC—W/Pow. Sup... N: 59.50

RANGE FILTER	SIDE BAND	PHONE PATCH
FL-8 U: \$1.50	Loading Coil	TRANS-FORMER
N: \$1.95	C-114—\$1.95	C-161—\$1.95

### INDICATORS—OSCILLOSCOPES

#### PANADAPTERS:

- BC-1268 Radar-Indicator—25 Tubes... New: \$14.95
- Navy Model RDP—Pan. Adapter, 115 V 60 cycle... Used: 34.95
- BC-929 Oscilloscope—8 Tubes—Used: \$9.95—New: 14.95
- 1D-60/APA-10 Panoramic Signal Analyzer—New: 49.50

### 12 VDC DYNAMOTORS:

- |                         | NEW:    | USED:   |
|-------------------------|---------|---------|
| 425 VDC—225 MA—DM-35    | \$14.95 | \$11.95 |
| 220 VDC—80 MA—DM-34     | 4.95    | 2.95    |
| 549 VDC—450 MA—DA-12    | 14.95   | 11.95   |
| 425 VDC—163 MA—WE-377   | 13.95   | 9.95    |
| 225 VDC—100 MA—D-402    | 8.95    | 5.95    |
| 230 VDC—90 MA—PE-133    | 4.95    | ...     |
| 150 VDC—100 MA—DM-310X  | ...     | 2.95    |
| 250 VDC—60 MA—DM-32-12V | 4.95    | ...     |
| 250 VDC—50 MA—DM-25     | 4.95    | 2.95    |
| 500 VDC—50 MA—USA/0515  | 4.95    | 3.95    |
| 24 VDC—1.5 A—USA/0515   | 4.95    | 3.95    |
| 300 VDC—150 MA—CTR-124  | 5.95    | 4.95    |
| 230 VDC—90 MA—DM-21     | ...     | 5.95    |
| 275 VDC—150 MA—DM-64    | 8.95    | ...     |

### 6 VDC DYNAMOTORS:

- 640 VDC—260 MA—Reconditioned by G.E. \$12.95
  - 420 VDC—260 MA—Reconditioned by G.E. 9.95
- Send us Your Specifications and requirements for other type Dynamotors—Inverters—Generators!

### MISCELLANEOUS:

- EE-8 Field Telephones—Used, Checked... \$14.95
- RM-29 Remote Control & Tele. w/Handset. New: 8.95
- RC-58 Facsimile Set... New: \$9.95
- T-208 FM Signal Generator—New: \$70.50. Used: 59.50
- RD-7/APA-23 Radar Pulse Rec.—N: \$29.95. U: 19.95
- BC-906 Freq. Meter, Absorption Type—N: \$9.95. U: 6.95
- Ultra Violet Black Light Crime Detector... 69.50
- SCR-625 Mine Detector—Reconditioned... 29.95
- AN/APA-4-3 CM-X Radar Set—Complete... 69.50

## PRACTICE CODE TAPE SETS

INKED PAPER TAPES—For code practice and training—for radio operators, Hams, amateurs, beginners, and telegraphers. 15 lessons to a set on 16 mm 400 ft. reels that can be reproduced on TG-34A and TG-10 Keyers. SET OF 15 REELS IN WOOD CASE... **\$18.95**

TG-34 KEYSER—New: \$24.95 • TG-10 KEYSER—Used: \$24.95

Address Dept. RN • \$5.00 Order Minimum, & 25% Deposit on C.O.D.'s • Prices are F.O.B. Lima, Ohio

# FAIR RADIO SALES 132 SOUTH MAIN ST. LIMA, OHIO

## IMMEDIATE DELIVERY ON RECORD CHANGER REPLACEMENT PARTS

We carry in stock all parts for every record changer—both domestic and foreign. Send us a list of your needs. Same day shipment.

### REPAIR SERVICE

If you can't repair your record changer, send it to our repair specialists for prompt service at reasonable charges. Workmanship and parts guaranteed.

### EXCEPTIONALLY LOW PRICES ON

- Record Changers
- Speakers
- Baffles
- Cartridges
- Needles
- Cabinets
- Spindles

ALL SHIPMENTS MADE C.O.D.  
**RECORD CHANGER SERVICE**  
81 Cortlandt St. New York 7, N. Y.

## ENGINEERING



**B.S. DEGREE IN 27 MONTHS**

Prepare for unlimited opportunities of the Electronic Age! Earn your B.S. DEGREE IN 27 MONTHS in Aeronautical, Chemical, Civil, Electrical or Mechanical Engineering; in 36 MONTHS in Mathematics, Chemistry, Physics. Intensive, specialized courses. Comprehensive training in electronics, television, advanced radio theory and design, math, nuclear physics and electronic engineering. Engineering Science Preparatory courses. Low rate. Graduates in demand. Spacious campus; 20 bldgs., dorms, gym, playing field. Earn part of your expenses in Fort Wayne while studying. G.I. approved. Enter June, Sept., Dec., March.

### INDIANA TECHNICAL COLLEGE

968 E. Washington Blvd., Fort Wayne 2, Indiana  
Please send me free information on B.S. ENGINEERING DEGREE IN 27 MONTHS as checked.

- Electronics  Chemical  Aeronautical
- Civil  Mechanical  Electrical
- B.S. DEGREE IN 36 MO.  Math.  Chem.  Physics

Name .....  
Address .....







huge cymbal smashes and a tremendous bass drum that will really shake the house if played through a big system. All the stereo virtues are here . . . directionality, depth, a good spread across your living room "stage" with no middle hole to worry about and a round fullness of tone that is ultra-realistic. The other numbers are equally well played and recorded and especially noteworthy is the "Russian Sailor's Dance" from Gliere's "Red Poppy Ballet." All in all, a highly satisfactory group of tapes, ideal for its intended purpose and certainly well worth the money.

**TCHAIKOVSKY**

**SYMPHONY #6 (PATHETIQUE)**  
Sinfonia of London conducted by Muir Mathieson. Livingston 4002K. Price \$11.95.

This is a good straightforward performance of the work, which will be more than adequate for many people. It does not have the drama or power that the Monteux reading does on *Victor*, but it is many cuts above a number of performances on disc. The name of the orchestra is a pseudonym of course, as it plays very well and is most likely the London Symphony or Royal Philharmonic. The sound is quite good, not having the instrumental detail nor "liveness" of the *Victor*, but more than satisfactory. The aspects of depth and directionality were capably managed. The thing to remember here is that you are getting a reasonable representation of this long work at a price well below the cost of the *Victor* tape.

**SPEED THE PARTING GUEST**  
Jimmy Carroll and percussionists. Cook 1041. Price \$11.95.

This was famous in its record format as a real lease breaker. Here in its stereo form, it hasn't gained as much as one might imagine, yet it has indeed been enhanced in body and in fidelity to the original instruments and sparkles with its new found directionality. Best thing, of course, is that freed from the restrictions of a record groove, the engineers can let the dynamics go all the way. Thus this report concludes with the fact that its reputation as a lease-breaker remains not only undiminished but has gained added luster!

**1958 ROCKIES ARRL MEET**

**THE Santa Fe Radio Club, Inc.** will play host to the 1958 Rocky Mountain Division Convention of the ARRL to be held in Santa Fe, New Mexico on June 14th and 15th.

Special activities have been planned for visiting XYL's and harmonics. Talks, mobile hunts, special interest luncheons, and lots of rag-chewing are part of the activities for all registrants, hams and non-hams alike.

Registration after June 1st will be \$8.50. Prizes galore will be given away.

For further information write or QSO with Bill Nohrn, W5UNB, P. O. Box 1002, Santa Fe, N. M.

Combine a vacation with a "trade session" at this convention!

June, 1958



Leo I. Meyerson  
WØGFG

Leo Says:

**Order Today from**

THIS

**ALL NEW**

**HAMMARLUND HQ-160**

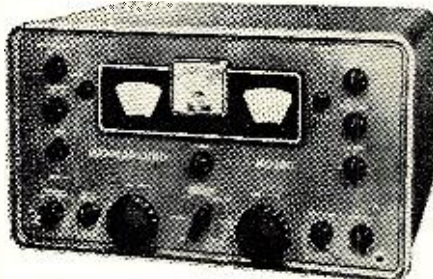

**ONLY \$2180 Per Mo. Just \$37.90 Down or \$379.00 Cash**

A great new, dual conversion, 13 tube superheterodyne general coverage receiver. 540 KCS to 31 MCS in 6 bands. Separate linear detector for optimum SSB and CW reception. Q-Multiplier, notch filter, BFO, crystal calibrator, 14 tuned circuits in IF and dial scale reset. Calibrated every 5 KCS to 10 MCS; every 10 KCS from 10 MCS up. Electrical band-spread. Calibrated at 80, 40, 20, 15 and 10M.

Send for Complete Information Today!

**World Radio!**

- \* **EASY PAYMENT**  
We finance our own paper, offering a really easy payment plan. You can be working your new equipment from World Radio while you pay. Only simple credit information is required.
- \* **ONLY 10% DOWN**  
On any item over \$35, you pay just one-tenth down. World Radio does everything in its power to make it easy for the ham to buy. Why not try us?
- \* **COMPLETE STOCKS**  
The foremost lines of major manufacturer parts are stocked here at World Radio. No waiting for factory shipment, no tie up in getting your order.
- \* **TOP TRADE INS**  
Our recommissioned list is the bible of the industry. This means that hundreds of ham trade at World Radio, proving our offer of the best trade around the country. Ask for a quote.
- \* **FAST SERVICE**  
Our location in the center of the U.S. our large processing staff and shipping department, all mean prompt, same day services to you. You get what you want, at once!
- \* **PERSONAL ATTENTION**  
World Radio is geared for individual service and counsel. No cold organized lines here, but top ham personnel to work with you when you ask for information or merchandise.

**FREE 1958 Catalog**

200 pages, hundreds of illustrations, 15,000 top value items write for yours, today!



Please send me Free Catalog . . . and complete info on THE HAMMARLUND LINE. R6-8

NAME: \_\_\_\_\_  
ADDRESS: \_\_\_\_\_  
CITY & STATE: \_\_\_\_\_

**GET INTO ONE OF THESE TOP OPPORTUNITY FIELDS**  
**ELECTRICITY**  
- Electronics of  
**TELEVISION**  
- Radio-Color TV

**TRAIN IN THE GREAT SHOPS OF COYNE**  
OLDEST, BEST EQUIPPED SCHOOL OF ITS KIND IN U.S.

**Veterans and Non-Veterans**—Prepare for a better job NOW that offers a real future, too! Get practical training in TELEVISION—RADIO—ELECTRICITY—ELECTRONICS—(Refrigeration & Electric Appliance Repair can be included). Learn on real equipment—no advanced education or previous experience needed. Lifetime employment service to graduates.

**Finance Plan**—enroll now, pay most of tuition later. Part time employment help to students.

**FREE BOOK** Clip coupon for Big Free Illustrated Book. No salesman will call. Act NOW.

B. W. COOKE, JR., President

**COYNE** FOUNDED 1899  
**ELECTRICAL SCHOOL**  
A TECHNICAL TRADE INSTITUTE OPERATED NOT FOR PROFIT  
500 S. PAULINA ST., CHICAGO, Dept. AS-6C  
ELECTRICITY • TELEVISION • RADIO • REFRIGERATION • ELECTRONICS

B. W. COOKE, JR., Pres., COYNE ELECTRICAL School  
500 S. Paulina St., Chicago 12, Ill., Dept. AS-6C

Send FREE BOOK and details on:  
 TELEVISION-RADIO  
 ELECTRICITY-ELECTRONICS

NAME.....  
ADDRESS.....  
CITY.....STATE.....

**SAVE 1/2 — PAY PART-BY-PART — HAVE FUN**  
**Assembling the SCHOBER ELECTRONIC ORGAN in KIT form**



Now you can afford a real, full concert organ, just like those made by the foremost organ manufacturers. Because over 1/2 the cost is saved when you assemble it yourself. And it's REALLY EASY: only 24 separate units, all with printed circuits, and detailed-to-the-smallest-step instructions. In addition, you purchase each of the 24 kits when you are ready for it — and can afford it.

You'll get a real kick out of putting the Schober Electronic Organ\* together — and then sitting down and pulling the stops for Strings, Trumpets, Clarinets, Diapasons, Flutes, etc. Electronic Percussion optional; chimes available.

**Compact CONSOLE**

One of the many exclusive features of this exceptional organ is the handsome console, in a wide variety of finishes. It is equally at home in a traditional or modern setting, and takes little more space than a spinet piano.

**Free Literature**

Complete descriptive booklet and price list are available on request. And, if you wish to hear the glorious pipe organ tone of the Schober Electronic Organ, a 10" long-playing demonstration recording is available for \$2. This is refundable when you order. Write today and see what a fine instrument you can get at such a great saving.

**The SCHOBER ORGAN CORP.**

2248-A Broadway, New York 24, N. Y.

\*Designed by Richard H. Dorf



**2 YEARS  
OF STUDY  
can give you these  
ADVANTAGES**

- Associate in Applied Science degree
- Preparation for a career as an engineering technician in

**ELECTRONICS  
ELECTRICAL POWER  
METALLURGY  
COMPUTERS  
AIR CONDITIONING**

- or you can continue without loss of credit to a 4-year Bachelor of Science degree in Mechanical or Electrical Engineering

at **M S O E**  
in Milwaukee

THE  
ENGINEERING  
TECHNICIAN

**FREE** folder answers your questions about the Engineering Technician, who he is, what he does, and how to become one.

**SEND TODAY**

**MILWAUKEE  
SCHOOL OF ENGINEERING**  
1025 N. Milwaukee St., Dept. RT-658  
Milwaukee, Wisconsin

Please send free folder

- "The Engineering Technician,"  
 Booklet "Your Career in Engineering."  
(please print)

I'm interested in \_\_\_\_\_  
(name of course)

Name \_\_\_\_\_ Age \_\_\_\_\_

Address \_\_\_\_\_

City \_\_\_\_\_ Zone \_\_\_\_\_ State \_\_\_\_\_

Eligible for vets. educational benefits  
 yes  no.

Discharge date \_\_\_\_\_

MS-94

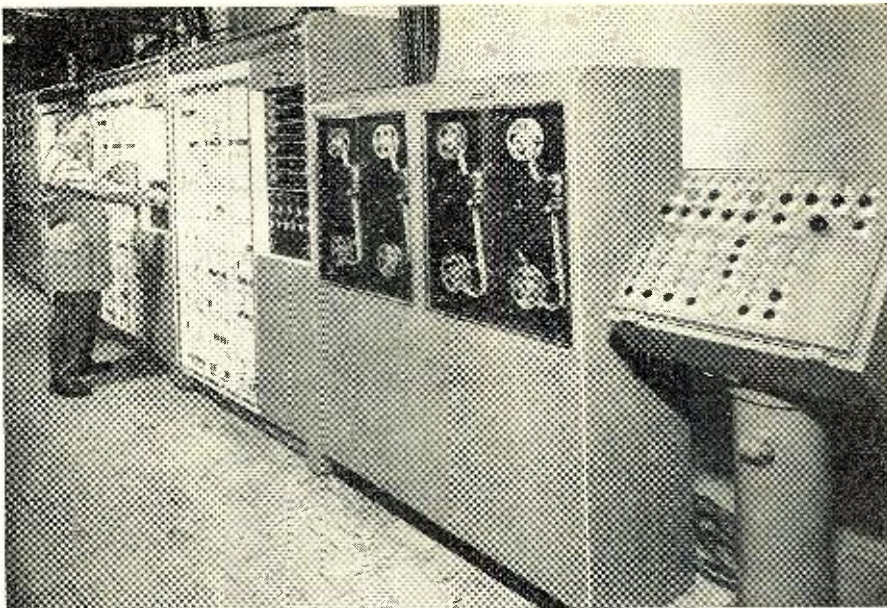

Pictured are the Digitape control cabinets for the first all-electronically controlled line of machine tools. At extreme right is master control panel which can start and stop tape-readers, machines, and transfer line. Next toward left, four tape-readers feed tape through sensitive metal fingers that "feel" the punched data. To left of tape-readers, control cabinet for boring machine takes information from readers, converts it into instructions for machine movement and operation. Research assistant is shown making routine check of control cabinet for drilling machine. Behind him is located the milling machine control cabinet.

## All-Electronically Controlled Machine Tool Line

*Punched tapes and transistorized digital computers control machine tools in long-secret Hughes plant.*

THE nation's first all-electronically controlled line of machine tools, operated from punched tapes and controlled by transistorized digital computers, was unveiled recently. The line is producing vital parts for the Hughes electronic armament control systems which are the "heart and brains" of all American and Canadian Air Force all-weather interceptor airplanes guarding the North American continent. So closely had the wraps been held on the operation that not even employees of the nearby plant where the parts are used knew of its existence or nature.

The company's Digitape electronic controls have been linked with a milling machine, a drilling machine, and a boring machine. The result is to make available the economies of mass-production techniques in the area of small-lot production.

In actual use a planning engineer first takes an ordinary blueprint of the part to be produced, and lists dimensions and the proper sequence of machining operations on a simplified planning sheet. A typist next transcribes the planning sheet data on punched tape, using a special keyboard. The completed tape is inserted

in a tape-reader and the information is then fed into the computing "brain" of the system. Using the taped data, the controls give measuring, positioning, and cutting orders to machine tools that are employed on the automated line.

-30-

All the machined parts pictured here can be manufactured simultaneously on the machine tool line. Parts have been through milling, drilling, and boring machines.





**A Theatre Organ  
for YOUR HOME!**

The Artisan simplified step-by-step assembly system with all mechanical and wood parts fully assembled lets you build a magnificent 2-manual and full pedal organ at a saving of up to 50%! No special skill needed!

the *Artisan*  
ELECTRONIC ORGAN



Order  
Direct from

**ELECTRONIC ORGAN ARTS, INC.**  
4878 EAGLE ROCK BLVD. DEPT. C26, LOS ANGELES 41, CALIF.

New  
12" LP  
ALBUM

Only \$2.98

Hear the thrilling tones of the Artisan as played by prominent artists of the Theatre Organ. With explanatory notes.

PORTFOLIO OF ORGAN FACTS jam-packed with vital information about organs. Only \$1.00

(LP Album and Portfolio—both for only \$3.49)

**GET INTO  
EL CTRONICS**

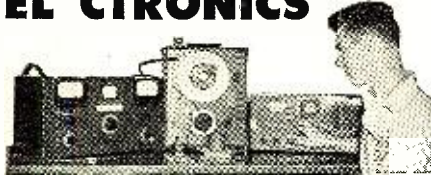

V.T.I. training leads to success as technicians, field engineers, specialists in communications, guided missiles, computers, radar and automation. Basic and advanced courses in theory and laboratory. Associate degree in electronics in 29 months. B.S. in electronic engineering obtainable. ECPD accredited, C.T. approved. Graduates in all branches of electronics with major companies. Start September, February, Dorms, campus. High School graduate or equivalent. Catalog.

**VALPARAISO TECHNICAL INSTITUTE**  
Dept. RD Valparaiso, Indiana

**JUST STARTING IN TV SERVICE?**

**-- then you need us!**

**FREE** GET STARTED RIGHT by writing for our 24 page catalog illustrating over 30 business forms and systems designed specifically for TV-Radio Service.

ON SALE AT YOUR PARTS JOBBER

Delrich Publications • 4308 N. Milwaukee • Chicago 41, Ill.

**THE ALLSOLVER**

TO ADD, SUBTRACT, FIND ROOTS, POWERS, SIN, COS, DIVIDE, MULTIPLY, SOLVE TRIG AND ALGEBRA

Now TRANSISTORIZED, with special dials to add several numbers at once, multiply as many as ten numbers at once by adding a few more parts! . . . Based on the principle of Analog computers . . .

**COURSES:**  
C14 Computer Master, 50 lessons plus projects. Diploma issued. \$22.50 down, then \$12.40 for six months.  
C15 Electronics, radio, television, computers, tele-metering and radar. \$22.50 down and then \$10.00 for five months.  
Ask for our new catalog . . .

EBE Inc., 1015 Atkin Ave., Salt Lake City 6, Utah

Send the ALLSOLVER encl. \$38.50 ppd.  
 Enroll me in course. . . . . Encl. \$22.50  
 Send free catalog

Attach name and address

**I. F. Alignment**  
(Continued from page 41)

between the two coils can be increased by screwing one or both in toward the center of the core, as shown in Fig. 7B. The slugs can be screwed in to the point where they are projecting into the coils by about the same amount as they were in Fig. 7A, although they will now be physically displaced. Nevertheless, they can be adjusted for the same inductance and therefore be tuned to the same frequencies.

It will often be sufficient to change the position only of the trap slug in this way. Even so, it will be necessary to touch up the alignment of the transformer slug slightly, as the closer proximity of the trap slug will have some detuning effect.

A response curve like that in Fig. 8 usually indicates regeneration is occurring in the stage tuned to the frequency of the peak. The most common cause of this is an open screen bypass capacitor.

On the other hand, the response curve may show a phenomenon that appears to be the opposite of this: instead of a peak, there will be a dip in response. This indicates that a trap has been misadjusted and is chopping out part of the desired bandpass. It is always good practice to check all traps for correct adjustment before peaking of the transformers is attempted.

If you have never done much in the way of complete alignment, you will be surprised to find out how simple it is when tackled in the right way. There is no substitute for doing. A couple of hours of practice with a set known to be in good shape is invaluable.

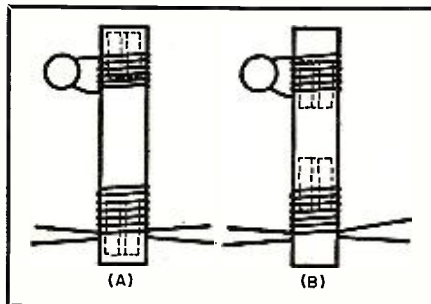
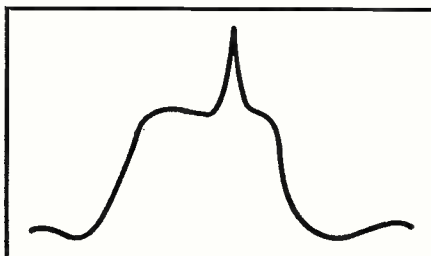

Fig. 7. For closer coupling between a trap and its associated i.f. transformer (A), the slugs of each may be screwed in toward the other one (B).

Fig. 8. This response-curve peak indicates regeneration in the i.f. strip.



**PERFORMANCE  
IN A SMALL PACKAGE**



The Handy Five-Pak  
(Shirt Pocket Size)

**Tarzian**

SERIES

**Silicon Rectifiers**

- COMPACT—no special holder required . . . supported by pigtail leads
- VERSATILE—will fit into the smallest pocket portable . . . yet enough power for the biggest color television receiver
- ECONOMICAL—Tarzian's mass production means lower cost to you
- PROVED-PERFORMANCE—in all electronic applications

Send for data sheets.

**SPECIFICATIONS**

	40K	K-200
MAX. AC INPUT VOLTAGE	130	130
MAX. PEAK INVERSE VOLTAGE	400	360
MAX. PEAK CURRENT (MA)	7500	2000
MAX. DC CURRENT (MA)	750	200
APPROX. RECTIFIER VOLTAGE DROP	2	2
MAX. OPERATING TEMP.	100°C	100°C
MAX. SURGE CURRENT (AMPS)	30	20
MIN. SURGE LIMITING RESIS. (OHMS)	7.5	10

**DIMENSIONS**

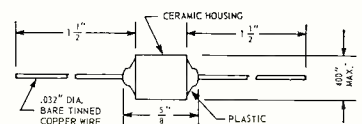

**Sarkes  
Tarzian**

DEPT. N-2  
RECTIFIER DIVISION, 415 N. COLLEGE AVE.  
BLOOMINGTON, INDIANA

IN CANADA: 700 WESTON RD., TORONTO 9, TEL. REGIONS 2-7555  
EXPORT: AD AURIEMA, INC., NEW YORK CITY



SATELLITES

ROCKETS

MISSILES

SPACE  
PROJECTS

ELECTRONICS -  
AERONAUTICS  
TECHNOLOGY

Prepare Now at

**NORTHROP**

for a brilliant career in the  
TECHNOLOGICAL WORLD  
of Today and Tomorrow!

This is the Technological Age — the time when men with Engineering Know-how can write their own ticket — pick their own field of specialization in Electronics and Aeronautics. YOU can EARN HIGH SALARY — and have an unlimited future — if you decide NOW to prepare for an ENGINEERING TECHNOLOGY CAREER.

**AT NORTHROP INSTITUTE**

— one of the country's leading institutions of technological education — you can complete your training in JUST TWO SHORT YEARS.

Recognized throughout the AVIATION and ELECTRONICS INDUSTRIES as an "industry" school, and with thousands of successful graduates now employed by Industry — you owe it to yourself to get complete information about what Northrop Institute can offer you.

Approved for Veterans



**Northrop**  
Aeronautical Institute

An Accredited Technical Institute  
1185 W. Arbor Vitae Street  
Inglewood 1, California

Mail Coupon for Complete Information

**NORTHROP AERONAUTICAL INSTITUTE**

1185 W. Arbor Vitae Street, Inglewood 1, Calif.  
Please send me immediately the Northrop catalog, employment data, and schedule of class starting dates. I am interested in:

- Electronic Engineering Technology
- Aeronautical Engineering Technology
- Aircraft Maintenance Engineering Technology
- Master Aircraft and Engine Mechanic
- Jet Engine Overhaul and Maintenance

Name..... Age.....

Address.....

City..... Zone.. State.....

Veterans: Check here  for Special Veteran Training Information.

**Portable Paging System**

(Continued from page 47)

A pair of 8" to 12" diameter PM loudspeakers may be substituted directly for the paging trumpets, provided the units have 8-ohm voice coils. Or, if preferred, a single 10" or 12" speaker with a 4-ohm voice coil may be used.

The Argonne type AR-503 output transformer used in the model provides a good impedance match between the push-pull transistor stage and the parallel 8-ohm trumpet voice coils (4 ohms total). However, if the individual builder intends to use his completed amplifier as a general purpose instrument, he will prefer to have a choice of output impedances. In such a case,  $T_2$  may be replaced with Lafayette's new TR-94 "universal" power transistor output transformer. This latter unit will match to 4-, 8-, or 16-ohm load impedances.

Except for bias resistors  $R_2$  and  $R_3$ , most of the smaller component values are non-critical and substitutions may be made at will. For example,  $C_1$  may range in value from 0.01 to as high as 0.04  $\mu$ fd. and  $C_4$  may be any value from 0.03 to 0.08  $\mu$ fd. Either paper or ceramic capacitors may be used for either of these two components as long as the rated working voltage is at least 75 volts. The author used 200-volt tubular paper capacitors in the model.

The values of the electrolytic capacitors,  $C_2$  and  $C_3$ , are also noncritical and much larger units may be used here if desired.  $C_2$  may have a rated value as high as 250  $\mu$ fd., while  $C_3$  can be as large as 2000 or 3000  $\mu$ fd. Substitute electrolytics should have a working voltage of at least 15 volts d.c., but need not be miniature or subminiature units.

Adjustable resistor  $R_1$  may be replaced by controls with a total resistance from as low as 500 to as high as 2500 ohms. Since a semi-fixed adjustment is used, control taper is not important. Either carbon or wirewound potentiometers may be used here.

Other types of power transistors may be used in the same basic circuit, of course, but if different types are substituted for the RCA units, it may be necessary to change the bias (by changing the ratio of  $R_2$  and  $R_3$ ) and to use other input and output transformers to insure optimum circuit operation. The RCA 2N301A may be used as a direct substitute for the 2N301, however.

The heavy duty 6-volt batteries specified in the parts list (Burgess type 2F4) and shown in the photographs of the model were chosen for two reasons (a) because of their long operating life, running into the hundreds of hours in this application, and (b) because their comparatively heavy weight, located in the broad base of the completed instrument, pro-

vides a high degree of physical stability. However, almost any medium-duty 6-volt battery may be substituted for the specified units.

Typical substitute batteries are the Burgess type F4P1 or RCA type VS009. Six-volt lantern batteries, such as the Burgess type TW1 or F4H or the Homart type 4702 may be used if desired. In fact, a satisfactory "power pack" for emergency operation may be made up simply by connecting eight standard flashlight cells in series. Of course, a 12-volt auto storage battery (or a pair of 6-volt batteries) may be used for operating the instrument.

Irrespective of the power pack used, the builder should remember that, in general, the larger (physically) the battery used, the longer the expected operating life and vice versa.

Finally, other carbon microphones may be used in place of the specified type, provided they have similar characteristics.

*Adjustment:* With the system's assembly completed, the builder should carefully double-check all construction and wiring before installing the batteries or trying to operate the amplifier. He should be especially careful to check (1) polarity of electrolytic capacitor and battery connections and (2) correct color-coding of transformer and microphone leads. In addition, he should watch for mistakes in wiring, cold soldered (or unsoldered) joints, and accidental shorts. The small sub-chassis transistor heat sinks should be rechecked for possible shorts to the main chassis.

If the completed instrument passes these final checks, the batteries may be installed and the system given an operational test. The sensitivity adjustment ( $R_1$ ) may be made at this time.

Designed primarily for outdoor use, the amplifier has relatively high output and fairly good sensitivity. As a result, the system is easily affected by acoustic feedback and severe "squealing" or "howling" may occur if the instrument is operated indoors. Therefore, operational tests should be performed outdoors with the trumpet loudspeakers pointed away from walls or other objects which might serve as sound reflectors.

The operator should stand behind the amplifier and loudspeaker chassis, which can be placed on an upended box, on a tree stump, or on a small table or stand. The microphone is held in the hand in such a way as to point away from the loudspeakers, again, the purpose here is to minimize the possibilities of some acoustic feedback.

In use, the microphone is held moderately close to the mouth, say from one to four inches away, to minimize the pickup of background noises or extraneous conversations. A normal to moderately loud speaking voice is used; there is no need to shout as the amplifier has more than ample gain.



With the "push-to-talk" button on the microphone depressed, the speaker can check the operation of the system quite easily, either by counting slowly, reciting a short talk or, if he feels musically inclined, singing a song!  $R_1$  is then adjusted for optimum performance. In general, the adjustment chosen will be the one which gives maximum sensitivity and output before "squealing" or acoustic feedback occurs.

After  $R_1$  is given this initial adjustment, it need not be touched again for some time, unless the instrument is used under operating conditions widely different from those under which the original tests (and adjustment) are made.

### Operation and Use

In practical work, the portable paging system, since it is a self-contained unit, is simply carried to the desired operating area. It is placed on a table, desk, platform, stool, or any similar support so that its microphone is within easy reach of the operator. It is then positioned so that its trumpet loudspeakers easily cover the area to which messages must be delivered.

When an announcement is to be made, the operator simply removes the microphone from its bracket, holds it close to his mouth, depresses the push-to-talk switch, and "speaks his piece." Output volume may be controlled by holding the microphone closer to (or farther away from) the mouth or by speaking in a louder (or softer) voice. No warm-up time is required.

Since there is only one operating control, the system is easily used by unskilled or untrained personnel with a minimum of special instruction. The owner needn't worry about his batteries being run down by someone forgetting to turn the unit "off" after use.

**Maintenance:** With no tubes to burn out or fuses to "blow," about the only maintenance required is an occasional cleaning and, at long intervals, a replacement of the batteries. In practice, the d.c. operating voltages are not too critical. As a result, battery life can often be extended beyond the "normal" life expectancy by re-adjusting  $R_1$  as output volume drops.

**General operating notes:** The portable system is designed for general paging or p.a. applications, that is, the amplification and distribution of the human speaking voice. It is not intended to be used to reproduce music. Its frequency response is limited at the low-frequency end by the characteristics of the paging trumpets used (which "cut off" at about 400 cps) and at the high frequency end by the microphone (about 9000 cps). However, the range covered is more than ample for the reproduction of the human voice.

The distortion levels are fairly low, roughly comparable to those in a conventional vacuum-tube operated p.a. or paging system and, therefore, not noticeable under normal operating con-

## ADIO RECEIVER

Model RDO, 70-1000 MC, 110VAC, 60 cycles. Govt. acq. cost. . . . . **\$150000**

Circuits employed for signal reception comprise a first detector, high frequency oscillator, 5 stages of intermediate freq. amplification operating at 30MC, diode type second detector, one stage of audio amplification feeding into a bandpass filter, silencer amplifier coupled audio amplification and an audio freq. power output stage, narrow or broad band. COMPLETE WITH TUNING UNITS. BRAND NEW **\$119<sup>95</sup>**

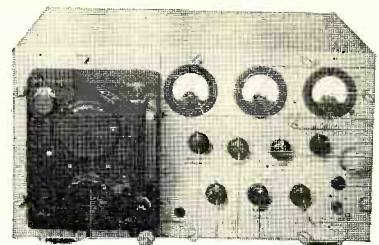

**RCA SIX TUBE** all purpose super het RECEIVER covering 195 KC to 9000 KC including weather lighthouse, aircraft radio range broadcast, marine and amateur 160 meter, 80 meter, 75 meter and 40 meter, with tubes and 24 volt dyno. EXC. . . . . **\$17<sup>95</sup>**  
8" x 10" x 18", ship. wt. 40 lbs.

**SCR 506.** A complete 80 watt mobile station, transmitter freq. 2 to 4.5 Mc, receiver freq. 2 to 6 Mc. COMPLETE WITH TUBES. 12 volt dynamotors J45 key, antenna, installation hardware, manual, etc. NEW . . . . . **\$59<sup>50</sup>**

**DYNAMOTOR . . . HIGH VOLTAGE**, high current 12 volt DC input, 440 volt, 400 MA output w/spare brushes. BRAND NEW **\$14<sup>95</sup>**  
EXC . . . . . **\$10.95**

**AN/APN-9 LORAN RECEIVER** inc. long range navigation unit. 12 or 24 volt. inst. **\$195<sup>00</sup>**  
UNUSED . . . . .  
APN 4B Complete, Brand New . . . . . **\$89.50**

## R W ELECTRONICS

WRITE FOR LATEST FLYER

2430 S. Michigan Ave., Dept. N, Chicago 16, Ill.

## LM FREQUENCY METER

Heterodyne crystal calibrated, modulated, 125 KC to 20,000 KC. Excellent, less **\$19<sup>95</sup>** calibration book. . . . .

**RT-18/ARC-1 VHF 10 channel crystal controlled** transceiver with tubes, dynamo- **\$139<sup>50</sup>**  
for and rack. EXC. . . . .

**BC-659 FM Receiver-transmitter**, xtal controlled, two channels, freq. range 27-38.9, 9 Mc. 13 tubes, built-in speaker, dual meter for testing filament and plate circuits. EXC. . . . . **\$6<sup>95</sup>**

**BC 683.** Ten Channel Push-button or continuous tuning FM RECEIVER 27 to 39 Mc complete with/tubes, speaker, squelch circuit. **\$12<sup>95</sup>**  
EXC. . . . .

**BC 603.** Same as above except to 20 to 27 Mc. . . . . **\$6.95**  
Brand New . . . . . **\$12.95**  
Exc. . . . . **\$6.95**  
Used . . . . . **\$4.95**  
12 Volt Dyna for above receivers. Exc. **\$2.95**

**BC669 Six Channel Crystal Controlled, 50 Watt Radio Telephone, 1600 to 4500 KC.** Ideal for boats or land station, less power supply. Exc. . . . . **\$79.50**  
Used . . . . . **\$59.50**

## STAMP OF APPROVAL! QUIETROLE

Only Known Merit marks a product as the "BEST"

for quieting Noisy Controls and Switches QUIETROLE produces results superior to any other product. That's why it's known as the "Best" and that's why more users prefer it to any other. It's the dependable Original product of its kind . . . a first in the Industry.

## QUIETROLE Spray-Pack



or the QUIETROLE Bottle with the Eye Dropper Cap

QUIETROLE offers you both types of containers. Either way assures you of the same un-failing results that QUIETROLE is known for.

The Lubricant Cleaner of the Electronic World. Tailored for the industry by over 15 years of authentic research, plus 4 years of rigid and exacting tests before marketing.

2, 4- and 8-oz. bottles with dropper and QUIETROLE SPRAY-PACK.

Ask for QUIETROLE and be sure you get it!

manufactured by

## QUIETROLE COMPANY

Spartanburg, South Carolina

## BUILD 16 RADIO

CIRCUITS AT HOME WITH THE NEW DELUXE 1958 PROGRESSIVE RADIO "EDU-KIT"



A Practical Home Radio Course Only **\$22<sup>95</sup>**

**FREE:** Set of Tools, Soldering Iron, Tester, Membership in Radio-TV Club; Consultation Service, TV, Radio, Hi-Fi, Quiz-Books, FCC Amateur License Training, Printed Circuitry, Pliers-Cutters, Alignment Tool, Wrench Set, Certificate of Merit, Valuable Discount Card.

The "Edu-Kit" offers you an outstanding PRACTICAL HOME RADIO COURSE at a rock-bottom price. You will learn radio theory, construction and servicing. You will learn to build radios, solder and wire in a professional manner, trouble-shoot radios. You will build a 16 Receiver, Transmitter, Code Oscillator, Signal Tracer and Signal Injector circuits, and learn how to operate them. You will receive an excellent background for TV. In brief, you will receive a basic education in Electronics and Radio, worth many times the small price you pay.

You will receive all parts, tools and instructions necessary to build 16 different radio and electronics circuits, each guaranteed to operate. Our kits contain tubes, tube sockets, variable, electrolytic and paper dielectric condensers, resistors, filo strips, coils, hardware, tubing, punched metal chassis, Instruction Manuals, etc. In addition, you receive Printed Circuit materials, including Printed Circuit chassis, special tube sockets, hardware and instructions. You also receive a useful set of tools, pliers-cutters, an alignment tool, wrench set, a professional electric soldering iron, and a self-powered dynamic Radio and Electronics Tester. The "Edu-Kit" also includes Code instructions and the Progressive Code Oscillator. You will also receive lessons for servicing with the Progressive Signal Tracer and the Progressive Signal Injector, TV, Radio, Hi-Fi and Quiz Books, FCC Amateur License Training.

All parts, components, etc. of the "Edu-Kit" are 100% unconditionally guaranteed, and carefully selected, tested and matched. Everything is yours to keep. The complete price of this practical home radio and electronics course is only \$22.95. Sold only by Progressive "Edu-Kits."

You will learn to trouble-shoot and service radios, using the professional Signal Tracer, the unique Signal Injector, and the Dynamic Radio and Electronics Tester. Our Consultation Service will help you with any technical problems.

J. Stasaltis, of 25 Poplar Pl., Waterbury, Conn., writes: "I have received several sets for my friends and made money. The 'Edu-Kit' paid for itself. I was ready to spend \$240 for a Course, but I found your ad and sent for your kit."

**PROGRESSIVE "EDU-KITS" INC.**  
497 UNION AVE., DEPT 78-E, BROOKLYN 11, N. Y.  
ORDER FROM AD-RECEIVE FREE BONUS RESISTOR & CONDENSER KITS WORTH \$7

UNCONDITIONAL MONEY-BACK GUARANTEE  
 I enclose full payment of \$22.95 for "Edu-Kit" sent postpaid.  
 I will pay postman \$22.95 plus postage for "Edu-Kit" sent COD.  
 Rush me FREE descriptive literature concerning "Edu-Kit." Also send me FREE valuable Radio, TV and Hi-Fi Books worth \$1.50. No obligation.

NAME . . . . .  
ADDRESS . . . . .



### METER SPECIAL

2 1/2" 0-50 Microamps. (Scale 0-5.) Each ..... \$4.95

### MOBILE DYNAMOTORS

SMALL SIZE

Input 1 1/2 to 12 Volts. Output 425 V. @ 375 Ma. .... Each ..... \$12.95  
 Input 5.6 to 6 Volts. Output 425 V. @ 375 Ma. .... Each ..... \$8.95

### FILAMENT TRANSFORMERS

Primary 115V. or 230V.-60 Cy. Sec. 6.3 V. @ 20 Amps. Size: H-4 1/2" x W-4" x D-3 1/2" ..... Each ..... \$3.50  
 Primary 110 volts 60 cycle. Secondary 2 1/2 V. 10 amps 10,000 V. Insulation. Suitable for pair of 866 tubes. .... \$3.95

### CHOKE—FULLY CASED

10 HENRY 80 Mil (unshielded) ..... 90c  
 6 HENRY 150 Mil ..... \$1.50  
 8 HENRY @ 200 Ma ..... 1.95  
 4 HENRY 300 Mil ..... 2.95  
 8 HENRY 500 Mil ..... 5.95

### OIL CONDENSER SPECIALS

#### BRAND NEW

2 MFD 600 VDC .50	6 MFD 2000 VDC 4.95
4 MFD 600 VDC .75	2 MFD 2500 VDC 2.50
6 MFD 600 VDC .85	4 MFD 2500 VDC 4.95
8 MFD 600 VDC .95	1 MFD 3000 VDC 1.85
10 MFD 600 VDC 1.19	4 MFD 3000 VDC 6.95
12 MFD 600 VDC 1.50	1 MFD 7500 VDC 6.95
1 MFD 1000 VDC .60	5 MFD 7500 VDC 2.95
2 MFD 1000 VDC .85	2 MFD 10,000 VDC 39.95
4 MFD 1000 VDC 1.15	1 MFD 12,500 VDC 29.95
8 MFD 1000 VDC 1.95	1 MFD 15,000 VDC 34.50
10 MFD 1000 VDC 2.95	1 MFD 25,000 VDC 69.50
12 MFD 1000 VDC 3.25	10 MFD 330 AC. 1.95
1 MFD 1200 VDC .45	15 MFD 440 AC. 2.50
1 MFD 1500 VDC .75	18 MFD 440 AC. 2.50
2 MFD 1500 VDC 1.10	(2000 DC) 2.35
3 MFD 1500 VDC 1.50	16 MFD 860 AC. 2.95
1 MFD 2000 VDC .85	
2 MFD 2000 VDC 1.50	
4 MFD 2000 VDC 3.50	

### REDMOND BLOWER

110V. 60 cyc. .3 Amp. 1600 Rpm. 3 3/4" Blower Wheel—Outlet 2" Diameter. Suitable for \$7.95 cooling Transm. tubes, etc. .... ea. \$7.95  
 2 for \$15.00

### ELECTRICAL TESTER

AC-DC PROBE—2 METERS IN PROBE

1 meter measures Voltage 55, 110, 220, 440. Second meter indicates whether AC or DC, and if DC, polarity at tip of probe. .... ea. \$5.50

### SIGMA 5F RELAY

16,000 ohm in dual 8,000 ohm coils. (Can be paralleled) SPDT adjustable silver contacts. Adjustable armature tension. Operates on 500 microamperes or less. Ultimate in sensitive relay. Ideal for precision control work ..... ea. \$3.95  
 Write for quantity prices.

### RELAYS

Sealed Claire SPST. Norm. closed 3000 ohm coil 4 ma. .... ea. \$3.95  
 Claire Telephone Type 11,300 ohm coil DPDT cont. 10 amp 125V. Sens. 4MA. ea. \$1.85  
 Hermetically Sealed Relay Coil 110V AC 60 cy SPDT Contacts 5 Amps. .... ea. \$1.75  
 110 V. AC DPDT Contacts 10 Amps. .... ea. \$1.95  
 110 V. AC TPD. .... ea. \$1.95  
 6 Volt DC DPDT H.S. .... 99c  
 12 Volt DPDT DC Relay ..... \$1.35  
 Each DPST Advance Relay ..... \$1.05  
 Each DPST Advance Relay ..... \$1.05  
 Cramer Time Delay Relay, 220V 60 cy. 45 sec. adj. 2 pole DT. .... ea. \$6.95  
 G.E. Plug in Relay 5 prong 10,000 ohm coil 1 mil. SPDT. .... ea. \$2.50  
 Telephone type relay 12 V. DC @ 30 ma. triple pole single throw. Normally open. G.E. Relay control, contains 8000 ohm relay, sensitivity 2 mils. 10 for \$9.25. ea. \$1.10

### PANEL METERS

G.E., WESTINGHOUSE, W.E., SIMPSON, etc.

**2" METERS**

0-200 Ma DC ..... 2.95	0-10 Mil DC ..... 3.95
0-500 Mil DC ..... 2.95	0-50 Mil DC ..... 3.95
1-0-1 Amps DC ..... 2.95	0-150 Mil DC ..... 3.95
0-10 Amps DC ..... 2.95	0-25 Amp DC ..... 3.95
0-25 Amps DC ..... 2.95	50-0-50 Amp DC ..... 4.50
18-36 Volts DC ..... 1.99	0-500 Volts DC ..... 4.50
0-50 Volts DC ..... 2.95	0-1 KV DC ..... 5.00
0-150 V. AC ..... 3.49	0-1.5 KV DC ..... 5.50
0-4 Amps RF ..... 2.95	0-150 V. AC ..... 4.95
	0-30 Amps RF with Ex. Therm. couple ..... 12.95

**3" METERS**

0-50 Micro (Sc. 0-100) ..... 6.95	Running Time Meter 0-9,999.9 hrs. 110 V. 60 cy. 12.95
0-100 Micro (Scale 0-3) ..... 5.95	Same as above but used ..... 7.95
0-5 Mil DC ..... 3.95	

### MISCELLANEOUS SPECIALS

N.E. 51 NEON LAMPS, Box of 10 ..... ea. \$1.00  
 Write for quantity prices  
 50 OHM 6 watt (Non-Inductive) ..... ea. 35c

All merchandise sold on a 10 day money back guarantee basis

Min. Order \$3.00—25% With Order—F.O.B. New York

# PEAK

ELECTRONICS COMPANY

66 W. Broadway, New York 7, N. Y., WO-2-5439

ditions. Noticeable distortion will be introduced if the operator shouts into the microphone while holding it close to his mouth.

As far as power output is concerned, there is no simple way to determine this where voice is used. Theoretically, a pair of 2N301 transistors operating in class B push-pull can deliver as high as 10 or 12 watts with reasonably low distortion. In practice, however, the actual power delivered by the amplifier will depend on the adjustment of  $R_1$ , the condition of the batteries, and on how loud the operator speaks into the microphone, as well as on how close he holds this instrument to his mouth. In any case, the amplifier can easily deliver enough power to drive the two paging trumpets to their full ratings.

Similarly, the range to which a voice can be projected as well as the area that can be covered by the system will vary considerably from installation to installation and on how the system is used. Often, the tonal quality of the operator's voice will have a considerable effect on carrying power, quite aside from any "boost" given by the paging system. —50—

### SUBSTITUTE GRID-DIPPER

By STAFFORD E. DAVIS, W5HDM

**T**he grid-dip meter is used to determine the resonant frequency of a circuit. It is one of the finest pieces of equipment to have on hand at an amateur station. The cost of this instrument, however, often makes it necessary for the ham to either borrow one or do without.

This meter is especially useful to the amateur who does a lot of coil winding on wave traps, transmitters, receivers, or similar equipment. Any transmitter can be used as a grid-dip meter, if the circuit to be measured is connected as indicated in the diagram, and the following instructions are followed. Set the voltmeter to the lowest scale. With the transmitter connected to the dummy load, and tuned to the desired frequency of circuit to be tuned, turn on carrier.

Adjust the variable element of the circuit under test (either slug or capacitor) until maximum reading is reached on meter. It will probably be necessary to set the meter on a higher scale as resonance is approached. Once a maximum reading is obtained, the circuit is adjusted to the same frequency as the transmitter. This method is especially good since an exact frequency adjustment is possible whereas only a relative frequency is possible with the grid-dip meter. —50—

Hook-up used for substitute grid-dipper.

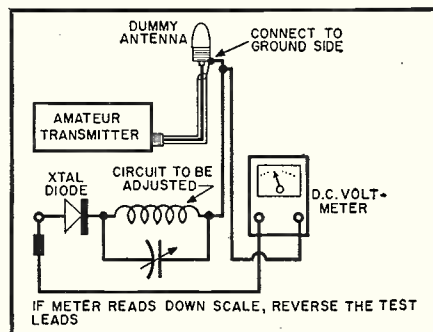

### New Stereo Disc

(Continued from page 53)

compliance about one- to two-thirds of the lateral compliance. It is interesting to note that if the vertical motion is allowed to be equal to the lateral motion at all levels and frequencies, as is the case with the 45/45 system, the majority of existing pickups simply would not track the groove unless the recording level is very appreciably lowered. This is undesirable as there would be less output from the record, and hum and noise would become very troublesome.

The reduced vertical motion in the CBS system does not limit the stereo effect at all, according to CBS laboratory listening tests. It was found, for example, that most of the radiated sound could be conveyed by the sum signal and that a much smaller amount of the difference signal is needed to produce the stereo effect. As a matter of fact, the user may be able to employ a 20-watt playback amplifier for the sum (lateral) channel, while only a 2-watt playback amplifier would be needed to add stereo by means of the difference (vertical) channel. The idea is quite akin to that used in color-TV. Here all picture detail and the over-all brightness of the image is conveyed by a wide-band brightness (monochrome) signal, while the color information is inserted by narrower-band color signals.

An automatic stereo recording amplifier is used during recording to modify the difference signal automatically. No such special circuits are needed at the playback end with the compatible disc.

### How It Sounds

For the demonstration a special CBS-Hytron horizontal-vertical ceramic cartridge was used. Actually, any of the presently available 45/45 pickups could also have been used by simply changing the pickup output or speaker output connections. The stereo effect was quite pronounced in the demonstration room. When the separate channels were played, sound could be clearly heard coming first from one and then the other speaker unit. Next, an existing monaural cartridge was substituted and the same record was played. Although all sound now came from a single speaker unit, sound quality appeared to be just the same as before but, of course, without the stereo effect.

Other record companies have criticized the system as not being "fully stereophonic" and as having insufficient channel separation. For evaluation, we will have to wait and see when and if commercial discs are marketed.

It appears now that in the field of disc recording, CBS has traded places with RCA to become the champion of compatibility. —30—



## ORDER by MAIL and SAVE! TV PICTURE TUBES

10BP4	\$ 7.95	17BP4	\$10.95	21AMP4	\$19.95
12LP4	8.95	17CP4	17.00	21ATP4	20.95
14B/CP4	9.95	17GP4	17.60	21AUP4	20.95
16DP4	14.95	17HP4	13.60	21EP4	14.95
16EP4	15.90	17LP4	13.60	21FP4	15.95
16GP4	15.90	17QP4	11.95	21WP4	17.30
16KP4	10.95	17TP4	19.30	21YP4	15.95
16LP4	10.95	19AP4	19.30	21ZP4	14.95
16RP4	10.95	20CP4	13.90	24CP4	23.95
16WP4	15.20	20HP4	17.95	24DP4	26.95
16TP4	10.95	21AP4	22.10	27EP4	39.95
17AVP4	15.20	21ALP4	20.95	27RP4	39.95

27"-6 month guarantee—all others 1 year. Aluminized Tubes \$5.00 more than above prices. These prices are determined to include the return of an acceptable similar tube under vacuum.

ALL PRICES FOB CHICAGO, ILLINOIS. Deposit required, when old tube is not returned, refundable at time of return. 25¢ deposit required on COD shipments. Old tubes must be returned prepaid. We ship anywhere.

WRITE FOR COMPLETE LIST.

### — PICTURE TUBE OUTLET —

3032 MILWAUKEE AVE.

CHICAGO 18, ILLINOIS  
Dickens 2-2048

## TAP RECORDERS

HI FI COMPONENTS  
Tapes—Accessories  
UNUSUAL VALUES  
Send for Free Catalog

### MERITAPE

Low Cost. High  
Quality Re-  
cording Tape—  
In boxes or  
cans.

### DRESSER

69-02 RA-174 St.  
Flushing 65, N. Y.



**BARGAIN HUNTING?**  
**TV SERVICEMEN!**  
Write for SENSATIONAL CATALOG  
**HENSHAW RADIO SUPPLY**  
3619 TROOST KANSAS CITY, MO.

## TAPE RECORDERS

WHOLESALE PRICES

### HI-FI COMPONENTS

NATIONAL BRANDS

WRITE FOR FREE CATALOGUE

**CARSTON**

215-RD E. 88 ST.  
NEW YORK 28, N. Y.

## BE QUALITY WISE... BUY QUAL-KITS!



**HI-FI AMP. KIT**  
Complete 6 tube-10 watt amplifier. Push-pull beam power output, built-in pre-amp, 5 position selector switch, 3 position record equalization, LP, RIAA, Eur. Response 1/2 db. 20-20,000 cps. Output 10 watts at less than 2% IM. Low noise level and harmonic distortion. **\$28.50**

Every kit complete with 28 page fully illustrated instruction and assembly manual. Cover and legs optional.

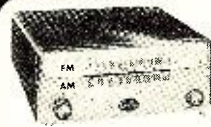

**HI-FI AM-FM TUNER KIT**  
Advanced 7 tube circuit plus Rectifier for full sensitivity and selectivity. Distortion less than 1%. Sensitivity is 5 uv for 30 db quieting on FM, 25 uv AM. Armstrong FM Circuit with limiter. Foster-Seeley Discriminator. 20-20,000 cps response. Full AFC control — no drift. Easy assembly. **\$28.95**

Add 10% Fed. Tax  
Write for FREE catalog and name of nearest dealer carrying these remarkable units.

## QUALITY-ELECTRONICS

319 Church St. Dept. T-6 New York 13, N. Y.

Within the Industry  
(Continued from page 22)

**HAROLD E. TYLER** . . . *International Resistance Company* has announced the death of **FRANK DENGLER**, purchasing agent.

\* \* \*

**GENERAL INSTRUMENT CORPORATION** has purchased the remaining outstanding stock (14%) of **RADIO RECEPTOR COMPANY INC.** Controlling interest in the firm was acquired by the parent company in April, 1957 . . . The corporate name of **PERMO, INCORPORATED** will be changed to **FIDELITONE, INCORPORATED** to conform with the widely known brand and trademark. The corporate structure, officers, directors, and ownership of the company remain the same . . . **NATIONAL ELECTRIC PRODUCTS CORPORATION** has announced that it has completed negotiations for the acquisition of **FREQUENCY STANDARDS, INC.**, Asbury Park, N.J. manufacturer of electronic apparatus and instruments. The firm will operate as a division of the parent company, with present personnel.

\* \* \*

**BOB MUELLER** and **LEON UNGAR**, partners in *Ungar-Mueller Sales Co.*, manufacturers' reps of Southern California, have received *General Cement's* "Salesman of the Year Award" for outstanding achievement in total volume and largest percentage increase in sales to distributors in the Western division during 1957.

\* \* \*

**JOSEPH H. ENEBACH**, supervising engineer at the *Illinois Bell Telephone Company*, has been elected president of the National Electronics Conference for 1958.

Other officers named are: Milton H. Crothers, executive vice-president; Charles W. McMullen, secretary; James H. Kogen, *Askania Regulator Company*, treasurer; Robert E. Bard, *General Radio Company*, executive secretary; and Gordon J. Argall, *DeVry Technical Institute*, assistant treasurer. —30—

## HAMFESTS SCHEDULED

**THE Uniontown Amateur Radio Club** has scheduled its annual "Gafest" for Saturday, June 21st at the Club House on the Old Pittsburgh Road, just off Route 51, two miles north of Uniontown, Pa.

For reservations write the Club at P. O. Box 849, Uniontown, Pa. Fee is \$2.00 and, as usual, the affair is strictly Stag! —30—

\* \* \*

**THE 1958 Alberta Ham Fest** will be held in Edmonton on August 23rd and 24th. A banquet, picnic, and special events have been planned by the committee.

Everyone is welcome. Those who plan to be in Alberta on those dates should contact the Northern Alberta Radio Club, Box 163, Edmonton, Alberta, Canada, for full details on the meet.

Both radio amateurs and high-fidelity enthusiasts will be warmly welcomed to this affair. —30—

# COMPLETE TRAINING FOR BETTER RADIO-TV SERVICE JOBS



Let these two world-famous Ghirardi training books teach you to handle all types of AM, FM and TV service jobs by approved professional methods—and watch your efficiency and earnings soar!

Completely modern, profusely illustrated and written so you can easily understand every word, these books pave the way to fast, accurate service on any type of radio and TV set ever made. Each book contains the latest data on the latest methods and equipment—NOT a re-hash of old, out-of-date material. Each is co-authored by A. Ghirardi whose famous **RADIO PHYSICS COURSE** and **MODERN RADIO SERVICING** were, for 20 years, more widely used for military, school and home study training than any other books of their type!

## THE NEW Ghirardi RADIO-TV SERVICE LIBRARY

Almost 1500 pages and over 800 clear illustrations show step-by-step how to handle every phase of modern troubleshooting and servicing.

### 1—Radio and Television Receiver TROUBLESHOOTING AND REPAIR

A complete guide to profitable professional methods. For the beginner it is a comprehensive training course. For the experienced serviceman, it is a quick way to "brush up" on specific jobs, to develop improved techniques or to find fast answers to puzzling service problems. Includes invaluable "step-by-step" service charts. 820 pages, 417 illus., price \$7.50 separately. (Outside U.S.A. \$8.00.) See combination offer below!

### 2—Radio and Television Receiver CIRCUITRY AND OPERATION

This 669-page volume is the ideal guide for servicemen who realize it pays to know what really makes modern radio-TV receivers "tick" and why. Gives a complete understanding of basic circuits and circuit variations; how to recognize them at a glance; how to eliminate guesswork and useless testing in servicing them. 417 illus. Price separately \$8.75 (outside U.S.A. \$7.25).

### New low price...you save \$1.25!

If broken into lesson form and sent to you as a "course," you'd regard these two great books as a bargain at \$50 or more! Together, they form a complete modern servicing library to help you work faster, more efficiently and more profitably. Completely indexed so you can look up needed facts in a jiffy.

Under this new offer, you save \$1.25 on the price of the two books—and have the privilege of paying in easy installments while you use them! No lessons to wait for. You learn fast—and you learn right!

## STUDY 10 DAYS FREE!

Dept. RN-68 RINEHART & CO., Inc.  
232 Madison Ave., New York 16, N. Y.

Send books below for 10-day FREE EXAMINATION. In 10 days, I will either remit price indicated (plus postage) or return books postpaid and owe you nothing.

Radio & TV Receiver TROUBLESHOOTING & REPAIR (Price \$7.50 separately)

Radio & TV Receiver CIRCUITRY & OPERATION (Price \$8.75 separately)

Check here for MONEY-SAVING COMBINATION OFFER. Save \$1.25. Send both of above big books at special price of only \$13.00 for the two (Regular price \$14.25). . . you save \$1.25. Payable at rate of \$4 (plus postage) after 10 days if you decide to keep books and \$3 a month thereafter until \$13 has been paid.

Name .....

Address .....

City, Zone, State, .....

Outside U.S.A.—\$8 for TROUBLESHOOTING & REPAIR; \$7.25 for CIRCUITRY & OPERATION; \$14 for both. Cash with order only, but same 10 day return privilege.



# STAN-BURN

## CATHODE RAY TUBE SPECIALS

### ONE YEAR GUARANTEE

G.E. Type	STAN BURN	G.E. Type	STAN BURN
\$15.80 .10BP4	\$10.00	\$24.75 .17LP4	\$8.00
19.10 .12LP4A	13.95	37.00 .19AP4A	24.00
. . . . .19QP4	11.50	28.35 .20CP4A	18.95
30.25 .12UP4	15.00	33.60 .21CP4B	21.95
20.75 .14CP4	13.75	36.00 .21AP4	25.00
. . . . .15DP4	14.50	29.75 .21EP4A	20.15
33.75 .16AP4	18.50	34.85 .21EP4B	23.95
32.20 .16DP4A	15.25	30.90 .21FP4	21.15
33.75 .16GP4	18.75	37.00 .21MP4	26.25
23.50 .18KP4	15.75	29.75 .21TP4	22.00
28.40 .18KP4*	18.75	34.85 .21TP4*	25.00
31.50 .16LP4A	16.25	28.30 .21ZP4	21.00
31.50 .16WP4	16.25	33.60 .21ZP4*	24.00
23.50 .17BP4	15.75	100.00 .24AP4	56.00
28.40 .17BP4*	18.75		(6 mos. guar.)
30.75 .17CP4	20.50	48.40 .24CP4*	38.00
33.90 .17GP4	21.50	90.00 .24DP4*	50.00

\*ALUMINIZED—INQUIRE FOR ANY TUBE TYPE NOT LISTED. STAN-BURN CRT TUBES RCA LICENSED—MFD. BY LINCOLN. All orders of 6 or more STAN-BURN CRT are subject to additional 10% discount. PRICES SUBJECT TO CHANGE WITHOUT NOTICE.

## WHY PAY MORE?

HI-FI COMPONENTS • KITS  
RECORD PLAYERS • TAPE RECORDERS • TUNERS • AMPLIFIERS • SPEAKERS • ELECTRONIC PARTS & TUBES • Etc.

Top brand nationally adv. merchandise in this and other Radio & TV sets designed for the finest, modern indoor and outdoor televiewing. Write for dealer price sheet and literature.



## SETCHELL-CARLSON PORTABLE TELEVISION

WITH 17" ALUMINIZED PICTURE TUBE, POWER TRANSFORMER OPERATED, UNITIZED CHASSIS, TOP-TUNING, RAZOR SHARP PICTURES. Has light weight aluminum chassis covered with colorful plastic coated fabric, styled and designed for the finest, modern indoor and outdoor televiewing. Write for dealer price sheet and literature.

## HI-FI DIAMOND NEEDLES—1 Yr. Guar.

Diamond needles reduce record wear and needle noise thus retaining full frequency response and tonal qualities of your records for a longer period of time.

SINGLE DIAMOND needle . . . . . \$7.95  
DIAMOND SAPP dual needle . . . . . 8.95  
Shipment PPD. (specify cartridge make)

## RECORD CHANGERS

COLLARO TC-340 4 speed changer . . . \$36.75  
COLLARO RC-440 4 speed changer . . . 40.67  
COLLARO TC-540 4 speed changer . . . 45.57  
GARRARD RC-88 4 speed changer . . . 53.41  
GARRARD RC-98 4 speed changer . . . 66.15

FREE wood mounting base, record wiping cloth and 45 RPM spindle with all orders for Collaro and Garrard changers, with this ad.

VM 4 SPEED HI-FI CHANGER—Model 1210 with Ronette or Astatic flip-over cartridge . . . . . \$22.95  
MONARCH Model UA8U 4 SPEED AUTO. INTERMIX CHANGER less cartridge \$19.85  
WECOR 4 SPEED CHANGER with turn-over cartridge . . . . . \$23.95  
RONETTE (phono fluid) cartridge flip-over type . . . . . \$2.98  
SONOTONE cartridge, flip-over . . . . . \$2.98  
45 RPM SPINDLE for V.M. or Monarch . . \$1.98  
WOOD MOUNTING BASE for V.M. or Monarch . . . . . \$3.95  
MOUNTING BOARD unfinished for V.M. or Monarch . . . . . \$1.50  
NEW GENERAL ELECTRIC HI-FI VARIABLE RELUCTANCE CARTRIDGE. Replaces discontinued RPX050 type. Full range reproduction 20-20,000 cycles. Four gram tracking force for minimum record and stylus wear.  
4G050—Dual Sapphire needles . . . . . \$8.77  
4G052—Diamond, Sapphire needles . . \$18.99

## KITS!

We stock the following manufacturers complete line of kits—see Advertiser's Index for reference pages.

EICO QUALITY CABINART  
DYNA BOGEN ELECTRO-VOICE  
ARKWAY GROMMIES

All domestic orders will be shipped prepaid! Send us your list. Order by Mfr. and Model No. of item.

## 520 WORTH OF ELECTRONIC PARTS IN GRAB-BAG

consisting of: Porcelain sockets, coils, speaker, trans resist. cond. ONLY . . . . . \$1.98 (plus C.O.D. postage)

## YOU NAME IT—WE HAVE IT

Complete line of T.V. & Radio receiving tubes, coils, transist. controls, antennas & accessories—No Minimum Order—DEALER DISCOUNTS! Thousands of satisfied HI-FI enthusiasts and dealers will vouch that STAN-BURN GIVES THE BEST DEAL POSSIBLE!

EXPORT INQUIRIES AND OFFERS INVITED  
Terms: 20% with order. Balance C.O.D. All prices F.O.B. NEW YORK Warehouse, Write for our latest price list and Hi-Fi Catalog RTV-5. All Prices Subject to Change Without Notice.

# STAN-BURN

RADIO and ELECTRONICS CO.  
558 CONEY ISLAND AVE. • B'KLYN 18, N. Y.

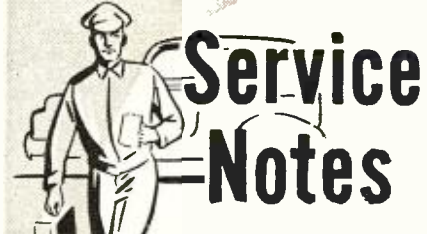

# Service Notes

## CROSLY FRINGE RECEPTION

Receivers in the J-21 Custom series (chassis 472, 473, etc.) may not in all cases perform up to their capability in fringe areas. This will be the result of variations in the characteristics of the 3BZ6 tubes used in the i.f. stages. Under certain conditions, the r.f. tuner bias will rise above its optimum operating level as a result of these variations. The result is a higher-than-normal snow level. To ascertain this condition when it is believed to exist, short out the tuner bias at the tuner itself while on a weak station. If snow decreases, the situation exists.

Once the condition is established in weak-signal areas, where the "local" position on the area switch is not

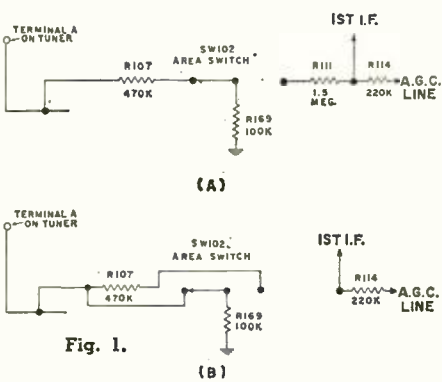

needed to control exceptionally powerful stations, a relatively simple wiring change can be made to improve signal-to-snow ratio. Remove resistor  $R_{111}$  from the circuit. See Fig 1. Transfer one end of  $R_{107}$  from the lug to which it presently connects on area switch  $SW_{102}$  to the lug vacated by the removal of  $R_{111}$ . Connect the lead from the other side of  $R_{107}$  (where it connects to  $C_{106}$ , not shown in the illustration) to the switch lug just vacated by the transfer of  $R_{107}$ . This change removes completely the original "local" position, and puts the "fringe" (or "normal") position in its place. The added "super fringe" position replaces the original "fringe" position.

## INSUFFICIENT WIDTH, MECK

When the raster of a TV receiver is not wide enough, normal adjustments or tube changes should always be attempted before any changes in the circuit are contemplated. In receivers using the 9018, 9022, and 9024 chassis, for instance, attempts should first be made to adjust the horizontal-size and horizontal-drive controls to produce adequate width. Next would be substitution of horizontal-oscillator and horizontal-output tubes. However, if these fail to produce desired results,

# SURPLUS BUYS!

TRIPLET MICROAMMETER—0-500 u/a Dc, 2 1/2" rd, bakelite case, white scale—ea. \$3.95  
G. E. METER—DW41. 2 1/2" rd, 0-500 mils., New . . . . . \$2.95  
METER—0-1 Mil (3KV scale) 3 1/2" rd, Marion—new . . . . . \$3.95

FILAMENT TRANSFORMER—2.5V—10 amps. 10 KV insulation. As used in BC610. New. . . \$3.95

PORTABLE AUDIO AMPLIFIER—1141F. Used with 625 mine detector. Compl. w/tubes, schem., cable, L.N. 12x4x4. 9 lbs. . . . . \$3.95

DUAL RECEIVER RACK (ARC-5)—Br. new \$1.95

COLLINS 20 watt MODULATION XFORMER—cased—3 for \$5.00 . . . . . ea. \$1.95

PHONE PATCH TRANSFORMER—1 1/2 cube. cased. w/schematic—simple, efficient. . . . . \$1.00

ARC—5 XMTR. 3-4MC—exc. cond. . . . . \$5.95

TS45A/APM-3—new—w/tech manual. . . \$39.95

5933/807W—ruggedized version of 807. Br. New—Sylvania Boxed . . . . . \$1.59, 2 for \$3.00, dozen \$15.00

POWER SUPPLY—RA-2B. Input 115V—60CPS. Output 1150 to 1420VDC—450 Mils. Cabinet 19x15x12. Wt. 150 Lbs. Brand new w/spare 866A's. Reduced. . . . . \$59.95

MIN. CARBON BUTTON MIKE—C-1 (ANB-MC1) w/plug. Br. new—6 for \$5.00 . . . . . ea. \$1.00

PLATE TRANSFORMER—Pri.: 115V-60CPS. Sec.: 550-0-550 220MA. (conservative) Collins cased. Each . . . . . \$6.95

COAX RELAY Advance #3305—Coil 100VDC. Supplied with matching coax connectors. New. . . . . \$5.95

NAVY PATCH CORD—2PL-55 type plugs on short cable. . . . . 49¢—5 for \$2.00

COLLINS LOW PASS FILTER—to 400 MC. w/2 coax conn. . . . . \$1.00

LEACH RELAY #1154—115VAC—DPST—New. Boxed . . . . . \$1.95

T40-APS/1B TRNSVR—115V—800 Cy—8 2 1/2 B Final. Blower, Relays, Metered—Br new 20 lbs. . . . . \$39.95

2AP1—RCA Boxed . . . . . \$1.95

**REX RADIO SUPPLY CO.**  
88 Cortlandt Street New York 7, N. Y.

# QUANTITY BUYERS

• AGGRESSIVE JOBBERS  
• LABORATORY SUPPLIERS  
• INDUSTRIAL DEALERS

Your opportunity to buy at maximum savings • These monthly listings are keyed to you • Standard brands • Fast moving • Below manufacturers cast

**WE OFFER**  
IMMEDIATE DELIVERY  
PHONE COLLECT  
FOR TECHNICAL INFORMATION  
NET TEN FOR TOP RATED HOUSES

\*\*\*\*\*  
\* Silver Ceramicon Trimmer—Erie Type \*  
\* 2N1POTS2A—3mmf—12 mmf—500 VDC \*  
\* For Sale in Lots of 1000 for \$85.00 \*  
\* GE Panel Meter—2 1/2" Rd.—Type 8DW \*  
\* 0—500 Mils. DC—Indiv. boxed \*  
\* For Sale in Lots of 75 for \$138.25 \*  
\* (\$1.75 ea.) \*  
\* TUBES—Special Purpose—TUBES \*  
\* 2C4—Sylvania, boxed—100 for \$25.00 \*  
\* 5933/807W—Sylvania, boxed—100 for \$85.00 \*  
\* 2AP1—RCA, boxed—100 for \$90.00 \*  
\* Variable Condensers \*  
\* 100 MMFD—23 Plate—2.5 Kv Gap—Hammarlund—100 for \$75.00 \*  
\* 140 MMFD—Apc Type W/Shaft—100 for \$40.00 \*  
\* Oil Condensers \*  
\* 10 MFD—600 VDC (Button or Porcelain Insul.) 100 for \$80.00 \*  
\*\*\*\*\*

**GREENWICH SALES CO.**  
Est. 1945  
59 Cortlandt St., New York 7, N. Y.  
DI 9-3813



add a capacitor (.05- $\mu$ fd. to .1- $\mu$ fd.) across the width coil.

### VIDEO RINGING, EMERSON

Some TV transmitters accentuate the higher video frequencies more than others to insure a crisper picture at the receiver even where bandpass of the latter may not be optimized. In receivers using the 120341H and 120342R chassis, such over-emphasis of these frequencies may result in high-frequency ringing, which shows up as closely spaced multiple images. If this symptom develops, it can be alleviated by shunting a resistor across  $L_{11}$ , the 660-microhenry shunt-peaking coil. The value of this resistor should be 4700 ohms at  $\frac{1}{2}$  watt.

### WIDTH INCREASE, TRUETONE

If sufficient horizontal size cannot be obtained on Models 2D2044 and 2D2047 of receivers bearing the *Western Auto (Truetone)* label, check to see where the high-voltage filter capacitor,  $C_{117}$ , is connected. In some sets, this capacitor was returned to ground. For more width, disconnect the ground end, reconnecting it to terminal 1 on the horizontal-output transformer.

### INTERLACE: MAJESTIC

If line pairing should develop in early versions of chassis 99, 103, and 105, the following changes should improve vertical interlace stability:

Add a 10,000-ohm resistor in the boost voltage line between the horizontal-linearity coil and the junction formed by  $R_{108}$  (screen resistor of the vertical-output tube) with  $R_{86}$  (vertical-size control). Connect one end of a .05- $\mu$ fd. capacitor to this same junction, connecting the other end to the 225-volt "B" source. Also connect a .25- $\mu$ fd., 200-volt capacitor across the vertical-deflection coils.

### VERTICAL HOLD, SYLVANIA

The range of the vertical-hold control may not be adequate in some receivers in the 1-532 series. Range of this circuit can be improved by the addition of two resistors. A 2.2 megohm unit, designated  $R_{331-1}$ , is connected to the same grid of the vertical oscillator

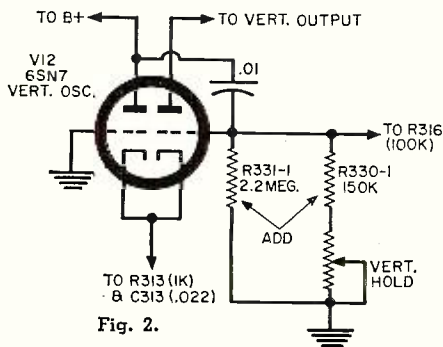

(see Fig. 2) to which the hold control is connected, with the other end being returned to ground. The connection from this grid to the hold control is severed and a 150,000-ohm resistor, labeled  $R_{330-1}$ , is inserted between the control and the grid.

# WE TRADE HIGHER!

## IT'S EASY TO DO BUSINESS WITH WALTER ASHE!

1. Just tell us what factory-built gear (made since 1945) you have to trade, and what new gear you wish to purchase. You'll get our top dollar quote by return mail.

2. When the deal is made, you ship your equipment to us by prepaid express or, if express is not available, by prepaid truck. We check it at once and, in most cases, your new gear is on its way to you within 24 hours after we receive your trade-in.

## SEND FOR OUR BIG FREE 1958 CATALOG

144 PAGES  
THE  
"TREASURE CHEST"  
OF VALUES

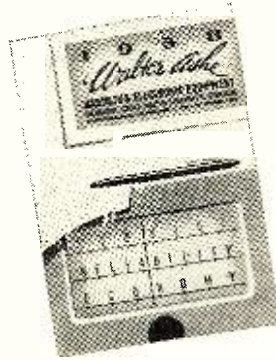

### SPARKY SAYS

HEY! LOOK!  
HOW ABOUT THIS?



WANT RECONDITIONED GEAR AT LOW COST? SEE WALTER ASHE!  
WRITE FOR FULL DETAILS ABOUT OUR TIME PAYMENT PLAN

All prices f. o. b. St. Louis

**Walter Ashe**  
RADIO CO.  
1125 PINE ST. • ST. LOUIS 1, MO.

WALTER ASHE RADIO COMPANY  
1125 Pine Street, St. Louis, Mo.

OUR 36TH YEAR

Rush "Surprise" Trade-In Offer on my.....  
for.....  
(show make and model number of new equipment desired)

Send new FREE 1958 Walter Ashe catalog. RN-6-58

Name.....  
Address.....  
City..... Zone..... State.....

## "NO NOISE" BIG 3

Beware Of Cheap Substitutes!



NO-NOISE NEW  
RUBBER COAT  
SPRAY

- Insulates where applied
  - Protects indefinitely
  - Prevents arcing, shorting, corrosion
  - Waterproofs thoroughly
  - Non-inflammable
  - Contains no plastic
- 6 Oz. Spray Can  
**\$3.25**  
Net To Servicemen

NO-NOISE  
VOLUME CONTROL  
and  
CONTACT RESTORER

- Cleans = Lubricates
  - Protects
- NOT A CARBON TET SOLUTION
- 2 Oz. Bottle **\$1.00**  
6 Oz. Spray Can **\$2.25**  
Net To Servicemen



NO-NOISE  
TUNER-TONIC  
With PERMA-FILM

- Economical—a little does a lot.
  - Cleans, lubricates, restores all tuners, including water type.
  - Non-toxic, non-inflammable
  - Use for TV, radio and FM
- 6 Oz. Aerosol Can  
**\$3.25**  
Net To Servicemen

**ELECTRONIC CHEMICAL CORP.**  
813 Communipaw Avenue Jersey City 4, N. J.

## WILL YOUR REPLACEMENT Fuse-Resistor BURN OUT AGAIN?

Not if you use—  
The NEW SENCORE  
"FUSE-SAFE"  
CIRCUIT TESTER

Save costly call backs by testing the circuit before replacing fuse, fuse resistor or circuit breaker.



Individual scale for each value fuse resistor — no interpretation, just read in red or green area.

★ Measures line current and up to 1100 watts of power at 115 volts using line cord and socket.

★ Two convenient current ranges — 0 to 2 amps and 0 to 10 amps. Test leads clip in place of fuse or fuse resistor.

★ 5 ohm, 10 watt resistor prevents TV circuit damage and simulates operating conditions.

As Recommended by Leading Manufacturers

Mfg by **SENCORE SERVICE**  
INSTRUMENTS CORP.  
171 OFFICIAL RD., ADDISON, ILL.

Cut out this ad now for further information



**Advance** **BUY of the MONTH!**  
**SIGMA 4F RELAY**  
 Sensitive 24 VAC or 6 VDC SPDT...\$1.49  
 With Transformer for 110 VAC operation...\$1.89

**POWER SUPPLY KIT BARGAIN**  
 Primary 115V, 60 Cy. Sec. 400-0-400V. @ 200 Ma., 6.3V @ 5 Amp., SV @ 4 Amp. Std. Mounting, plus 6 Hy, 200 Ma. choke and Two 10 Mfd. Oil Condensers...ea. \$7.50

**STEPPING RELAY**  
 Resettable type, 3 deck 10 position with additional 1A and 1B contact at reset position. Stepping coil...ea. \$8.95

**STEP UP-DOWN TRANSFORMER**  
 750 Watt 110/220 V. 60 cycle...ea. \$5.95

**TRANSFORMERS**

6.3 V FILAMENT	1 Amp. .... \$1.19
35 Amp. .... \$7.80	
20 Amp. .... 3.95	2 1/2 V Sec. 10 Amps.
10 Amp. .... 3.40	110 V Pri.
7 1/2 Amp. .... 1.99	Excellent for pr.
3 Amp. .... 1.89	of 866's .... \$3.95

**SCOOP! AC Blowers, 115 VAC, 120 CFM. \$995**

**OIL CONDENSER BARGAINS**

1 Mfd 600 VDC \$ .25	10 Mfd 1500 VDC \$3.75
2 Mfd 600 VDC .45	2 Mfd 2000 VAC 1.50
4 Mfd 600 VDC .75	3 Mfd 2000 VDC 2.75
10 Mfd 600 VDC 1.10	15 Mfd 1500 VDC 3.95
25 Mfd 600 VDC 3.40	2 Mfd 5000 VDC 8.75
20 Mfd 650 VDC 2.75	1 Mfd 3000 VDC 1.85
1 Mfd 1000 VDC .60	4 Mfd 4000 VDC 12.75
2 Mfd 1000 VDC .75	1 Mfd 5000 VDC 3.25
4 Mfd 1000 VDC 1.25	16 Mfd 2000 VDC 4.50
10 Mfd 1000 VDC 1.75	1 Mfd 12500 VDC 28.50
4 Mfd 1500 VDC 1.75	
5 Mfd 10000 VDC 40.00	

**PANEL METERS**

2" METERS	0-5 Ma. .... 3.95
0-120 Ma RF with external Thermo-couple .... 3.95	0-25 Ma DC .... 3.95
0-250 Ma DC .... 3.95	0-50 Ma DC .... 3.95
0-300 VAC .... 3.95	0-200 Ma DC .... 3.95
3" METERS	0-150 VDC .... 3.95
0-150 VAC .... \$4.95	200-0-200 V. DC. .... 3.95
0-15 DC KV 2" w/ shunt. .... \$8.95	0-1.5 Amps DC. .... 2.95
0-3 1/2 KV with shunt. .... \$6.95	0-15 DC KV 2" w/ shunt. .... \$8.95
2" Dual scale w/ high and low/switch 0-150V. DC. 0-7 1/2 V. DC. .... \$3.95	

**115 V. 60 CYCLES SELSYNS**  
 High torque BRAND NEW in original wrappings. Made for Bendix Aviation. 2 for \$10.50... Each \$5.95

**RELAYS**  
 110 V. A.C.—3 pole heavy duty dunco relay, 30 amp. con-tacts...ea. \$4.39

**RELAY**  
 6VDC P-B DPST 5 Amp Contact... \$1.29

**0-200 MICROAMMETER**  
 Mounted in Rubber case with cable...ea. \$2.95

**DU MONT POWER TRANSFORMER**  
 950 V. CT 300 ma; 2 6.3 V. @ 5 Amps; 2 5 V. @ 4 Amps...ea. \$7.50

**G. E. RELAY CONTROL**  
 (Ideal for Model Controls, Etc.)  
 Contains a sigma midget 8,000 ohm, relay (trips at less than 2 mA), high impedance choke, bi-metal strip, neon pilot and many useful parts. The sensitive relay alone is worth much more than the total low price of... \$1.10 Each 10 for \$9.25

**SPECIAL!! RG-8/U CO-AX CABLE**  
 52-ohm Imped. 100-ft. length \$5.75

**ANTENNA RELAYS**  
 12 Volt DC, DPDT plus extra SPST 10 amp contact. Low Loss ins...ea. \$1.39

**Signal Corps Earphones**  
 Hi-Impedance Dual Headset, complete w/ Headband & Cord. Used—terrific Value \$1.79 Per Set 2 for \$3.25

**Selenium Rectifiers**  
 30-36 VDC input, 24-28 Vdc output; 5 Amps ..... \$4.50 1/2 Amp ..... \$1.19 150 Ma 110V ..... \$1.29

Min. Order \$3.00—25% with order F.O.B. New York 10 DAY GUAR. PRICE OF MDSE. ONLY

**Advance Electronics**  
 6 West Broadway • New York 7, N. Y. • REclor Z-0270

**30 Watt Hi-Fi Super Lin Kit**  
 AMP-PREAMP with TRANSISTORIZED FRONT END

**FREQUENCY RESPONSE:**  
 ± 1 db 10-40,000 cps.  
 TUBES: uses (1) 6AU6, (1) 12AU7, (3) EL34's, (1) 6X4-RT  
 SHIPPING WEIGHT 26 lbs. FL-30 \$42.00 F.O.B. N.Y. Sale Price. Send for Free Catalogue write Dept. RN

**CUTICK ELECTRONICS HI-FI RADIO T.V. PARTS**  
 171 Washington St., Worth 2-5866, New York 7, N.Y.



**SENDING SPEED**  
**RECEIVING SPEED**

Be a "key" man. Learn how to send and receive messages in International Morse code. Communicate with operators around the globe. Learn at home quickly through famous Candler System. Used by best operators. Qualify for Amateur or Commercial License. Write for FREE BOOK.

**CANDLER SYSTEM CO.** Dept. 2-G, Box 9226, Denver 20, Colo., U.S.A.



**Service Industry News**



**WE DID IT.** For our first featured "Service Association of the Month," turn to page 100. Many of you who are members of local service-industry groups will be able to benefit from the experiences of the Milwaukee group featured in this issue. Conversely, other service associations throughout the nation may be able to learn something from your own operation. Whether they can or cannot, they—and we—would like to know something about your association and what it is doing. Why not fill in the coupon run with the "Association of the Month?" If you do, the questionnaire we send you will make it quite easy for you to tell us about yourselves without getting involved in a king-size project.

**Minnesota Fall Conference**  
 The Minnesota Television Service Engineers, Inc., are planning to sponsor an Upper Midwest Electronic Service Convention in the fall. It is planned to invite service dealers in a seven-state area to participate in the affair.

The apprenticeship standards developed by MINTSE have gained international attention. Government agencies in Canada, Cuba, Mexico, and Ireland were represented among the hundreds of requests received by the Minnesota Association for copies of the booklet detailing the standards. Copies of the booklet may be obtained by writing MINTSE, Inc., P. O. Box 4429, Minneapolis 21, Minnesota.

In North Carolina, most of the service associations have embarked on programs that have the worthwhile objectives of helping members to derive more profit from their activities. These programs revolve around adequate charges for service calls coupled with better public relations.

The Cataba Valley Radio & TV Association, which centers in Hickory, N. C., has been one of the leaders in the movement to put service on a higher income and public-acceptance plane. Howard Stutts is president of the Cataba Valley group; Earl Jones is vice-president; and Bob Patton is secretary.

The association recently sent out an invitation to all service dealers in its area urging them to take a part in the organization and make it a real community force. Information about the organization may be obtained by writing the Cataba Valley Radio & TV Association, 112 East First Street, Newton, N. C.

Earlier this year, the Cataba Valley Association helped dealers in Lenoir to form an association in that area. The Caldwell County Television Association

was formed with a charter membership of twelve shop owners. Officers selected to guide the organization during its first year include Herbert H. Griffin, president; Jack Kirby, vice-president; Woodrow Turnire, secretary; and Charles Corley, treasurer. Warren Angly, committee chairman, issued an invitation to all service dealers in that area to join and take an active part in the association. Information about its aims and objectives may be obtained by writing the Caldwell County Television Association, Box 17, Whitnel, N. C.

**Philadelphia Consolidation**  
 Three independent television service groups in Philadelphia, Pa., recently consolidated and formed the Television Service Association of Delaware Valley. The new organization is said to have a membership of 300.

The three associations that were involved in the consolidation were the Northeast Television Service Dealers Association, the Philadelphia Radio Servicemen's Association, and the Television Service Dealers Association of Philadelphia. The move was said to be in line with the long-range aims of the Council of Radio & Television Service Associations of Delaware Valley. The Council was the organizational vehicle through which these groups formerly cooperated on broad programs of interest to the independent service industry in the greater Philadelphia area.

The following were announced as some of the aims of the TSA of Delaware Valley: 1. To promote and protect the interests and welfare of the electronic service industry in the greater Philadelphia area. 2. To help police and enforce present laws against unethical practices with respect to consumer welfare. 3. To develop a public-relations program which will tend to create a better public understanding of the electronic service industry's problems. 4. To help elevate the radio and television service dealer's standards and income. 5. To cooperate with other trade associations and many segments of the electronic industry for the betterment of the industry.

Officers elected to serve during the initial year include: Ray Cherrill of the *Cherrill Radio & TV Service Co.*, president; John S. McCloy of *McCloy's TV Service*, vice-president; Harvey Morris of *Harvey's Radio & TV Service Co.*, secretary; Louis J. Smith of the *Louis J. Smith TV Service Company*, corresponding secretary; and Jack Rubin of the *Delaware Valley TV Service Co.*, treasurer.

In addition to Messrs. Cherrill, Mc-



AMAZING BUYS  
ON QUALITY HI FI

AT

# CENTER ELECTRONICS

## SCOTT 99-D AMPLIFIER



22-watt amplifier, including pre-amplifier with complete controls. This music center includes facilities for tape-recording, tape playback and speaker selection. Scratch and rumble filter. Your very best buy for the money.

Metal Case ..... \$ 9.95  
Wooden Case ..... \$19.95  
Amplifier ..... \$109.95

**CENTER PRICES  
ON REQUEST**

## STEPHENS TRUSONIC FULL RANGE SPEAKERS



Free cone suspension speakers have: smoothest full frequency response; maximum power-handling capacity; lowest distortion; best transient response; low, low free air resonance; high efficiency.

80FR — 8" ..... \$31.50

120FR — 12" ..... \$60.00

150FR — 15" ..... \$87.50

**CENTER PRICES  
ON REQUEST**

## MIRACORD XA-100



Push-button control and "magic wand" spindle — A precision instrument for both manual and automatic reproduction — THE FINEST BY FAR ..... \$67.50

**CENTER PRICE  
\$46.95**

Mail Orders 25% Deposit, Balance C.O.D.  
BASIC AMPLIFIERS • TUNER AMPLIFIERS  
PREAMPS • PICKUP ARMS • SPEAKERS  
SPEAKER ENCLOSURES • RECORD CHANGERS  
TAPE RECORDERS • CARTRIDGES • TURNTABLES • ETC. GET OUR SPECIAL PRICES.

**CENTER ELECTRONICS CO., Inc.**  
Dept. N 7, 72 Cortlandt St New York 7—CO 7-6474

# INFRARED SNIPERSCOPE TELESCOPE & PARTS

See in the dark—without being observed. War surplus Sniperscope M-2. Gov't cost about \$1200. Used for industrial plant security; research lab experiments; infrared photography; spectroscopy, etc. Instrument complete, ready to use. Includes Power Pack, infrared light source. Will operate from 6 V auto battery. Battery or transformer available.



Stock No. 85,053-DU ... Shipping **\$150.00**  
weight approx. 12 lbs. f.o.b. Barrington, N. J.

Order by stock No.—Send check or M.O.—money-back guarantee!

Save still more money! Build your own Sniperscope! We will furnish instructions—parts, including: Power Packs, 1P25A image tubes, light units, filters, etc. For details—request FREE Catalog "DU."

## SPECIAL! INFRARED 1P25A IMAGE TUBE

Stock No. 70,127-DU ..... \$9.95 pstd.  
Order by stock No.—Send check or M.O.—money-back guarantee!

## COLOR TV TUBESCOPE

Saves time, effort in alignment of color dot pattern.  
Stock No. 50,139-DU .22 power. \$24.50 pstd.  
Order by stock No.—Send check or M.O.—money-back guarantee!

## GET FREE CATALOG "DU"

America's No. 1 source of supply for experimenters, hobbyists. World's largest variety of Optical Items. Bargains galore. War Surplus—Imported—Domestic! Microscopes, Telescopes, Satellitescopes, Color TV Tubesscopes, Infrared sniperscopes and Parts, Prisms, Lenses, Reticles, Mirrors and dozens of other hard-to-get Optical Items.

WRITE FOR FREE CATALOG DU

**EDMUND SCIENTIFIC CO.**  
BARRINGTON, NEW JERSEY

Cloy, Morris, Smith, and Rubin, the Board of Directors includes Ralph Newby, Ray Fink, Charles Knoell, Al Haas, and Sam Brenner.

## Missouri Elections

Edwin Engel, of *Engel Radio & TV Service, Inc.*, Crystal City, Mo., was recently elected president of the Television Electronic Service Association of Missouri. TESA-Missouri is a NATESA affiliate.

Other officers elected at the recent annual meeting were: northeast vice-president, Denison Houghton of *People's Radio Shop*, Columbia; northwest vice-president, M. C. Crane of *Crane's TV & Radio*, St. Joseph; southeast vice-president, E. N. Carroll of the *Carroll Radio & TV Lab*, Cabool; southwest vice-president, W. A. Pryer of *Pryer Radio & TV Service*, Mountain Grove.

Carol King of *King's TV Clinic*, Lamar, was named secretary. Carl Adcock of *Carl's Radio & TV*, Aurora, was elected treasurer.

Directors, elected for two year terms, are: Robert Matteson of *Matteson TV Service*, Florissant; Howard J. Friener of *Empire Television Service Corp.*, St. Louis; Wayne Lemons of *A-1 TV & Radio Service*, Buffalo; and Arnet H. Patterson of *Patterson Radio & TV*, Springfield.

## Florida Convention

Swinging into high gear to promote their Southeastern Electronic Service Convention, which is scheduled to be held in the Miami Municipal Auditorium early in June, the members of the Radio & Television Technicians Guild of Florida, Inc., recently honored their outgoing president, George Peroni, as they installed the new officers who will guide the organization during the coming year.

Parker A. Latta, owner and operator of *Latta's Radio*, took over the helm as president of the Florida Guild. John J. Petruff of *John J. Petruff Electronics Consultants*, assumed the post of first vice-president, and James J. Ross of *Ross Television, Inc.*, stepped in as second vice-president.

The duties of corresponding secretary were taken over by Samuel Kessler of *Kessler Radio & TV* and those of recording secretary by Larry Lawrence of *Lawrence Radio & Electric*.

Ed Stevens of *Eagle Radio & Television* started on his eighth consecutive year as treasurer of the Guild by virtue of a unanimous vote of the membership.

Shan Desjardins, executive director of the RTTG, is handling the preparatory arrangements for the four-day June convention. Invitations are going out to service dealers in Florida, Georgia, Mississippi, Alabama, and Louisiana urging them to attend this first regional convention and exhibition ever held in the southeast for the benefit of independent electronic service dealers. Information about the convention may be obtained from Shan Desjardins, ex-

# FREE.

all-steel file cabinets  
with your purchase of  
**PHOTOFACT**

the world's finest TV-Radio Service Data



**FREE FOR REGULAR  
PHOTOFACT SUBSCRIBERS**

You get these valuable File Cabinets ABSOLUTELY FREE from Howard W. Sams if you are a regular subscriber to PHOTOFACT and buy each Set as issued monthly...

**FREE FOR PHOTOFACT  
LIBRARY PURCHASERS**

You get FREE File Cabinets as you complete your profit-building PHOTOFACT Library... What's more, you can own the PHOTOFACT Library the new Easy-Buy way. Here's how...

**NEW EASY-BUY PLAN**

No interest. No carrying charge. As little as \$10 down. Up to 24 months to pay. And Howard W. Sams will give you absolutely free all the steel file cabinets you'll need for your Library: Single-Drawer File Cabinet worth \$8.95 with your purchase of 60 Sets of PHOTOFACT Folders; Two single-drawer File Cabinets worth \$17.90 with your purchase of 120 Sets; Three single-drawer File Cabinets worth \$26.85 with your purchase of 180 Sets; Four single-drawer File Cabinets worth \$35.80 with your purchase of 240 Sets.

Take advantage of this money-saving opportunity. See your Sams Distributor today, or write to Howard W. Sams...

**GET THE FULL DETAILS**

**HOWARD W. SAMs & CO., INC.**

2203 E. 46th St., Indianapolis 5, Indiana

Send me full details on your FREE File Cabinet offer and EASY-BUY Plan.

I'm a Service Technician:  full time;  part time

My Distributor Is: .....

Shop Name: .....

Attn.: .....

Address .....

City ..... Zone ..... State .....



**Amazing New Handbook Takes The "Headache" Out of TV Trouble Shooting**

**Pin Point TV TROUBLES IN 10 MINUTES**

**SAVES TIME . . . ELIMINATES GUESSWORK!**

Now, a simple, practical way to accurately spot the cause of trouble in any TV set, FAST! Quick, easy-to-understand tests tell you in which of 5 TV set sections to find the cause of trouble. Fool-proof Check Charts help you locate the exact trouble spot at once, from as many as 700 possibilities. Book fits easily into your tool kit for handy on-the-job use. Over 300 spiral bound fast-reference pages with 50 time-saving Check Charts; dozens of easy to understand diagrams and tests; explanations of circuits and designs. The hours and aggravation this amazing handbook can save you on a single servicing job more than pay its low price!

**USE IT ON 7 DAYS FREE TRIAL!**

Send no money, just the coupon. We'll rush your copy on FREE TRIAL. After 7 days, send only \$3.95 plus postage or return the book and owe nothing. Act NOW!

**MAIL COUPON NOW!**

Educational Book Publishing Div.  
 COYNE ELECTRICAL SCHOOL, Dept. 68-RT  
 500 S. Paulina St., Chicago 12, Ill.

Rush TV handbook for 7 days FREE TRIAL per offer.

Name ..... Age .....

Address .....

City ..... Zone ..... State .....

Check here if \$3.95 enclosed. We pay postage. 7-day money-back guarantee.

**BUILDING A HI-FI SYSTEM?**

Send Us Your List Of Components For A Package Quotation

**WE WON'T BE UNDERSOLD!**

All merchandise is brand new, factory fresh & guaranteed.

**AIREX RADIO CORPORATION**  
 64 Cortlandt St., N. Y. 7, CO 7-2137

**PARTIAL LIST OF BRANDS IN STOCK**

Altec Lansing  
 Electrovoice  
 Jensen  
 University  
 Acoustic Research  
 Janszen  
 Wharfedale  
 Viking  
 Concertone  
 Bell • Lee • G.E.  
 Weathers  
 Harman-Kardon  
 Eico • Pilot  
 Sherwood  
 Acrosound  
 Fisher  
 Bogen  
 Dynakit  
 H. H. Scott  
 Pentron  
 Ampro • VM  
 Revere  
 Wallensack  
 Garrard  
 Miracord  
 Webster  
 Collaro  
 Thorens  
 Rek-O-Kut  
 Norelco  
 Fairchild  
 Pickering

Full Line of Cabinets

ecutive director of the RTTG of Florida, 119 N.W. 12th Ave., Miami 36, Fla.

**Bregenzner Re-elected**

Bert A. Bregenzner was elected to serve his fourth consecutive term as chairman of the Federation of Radio-Television Service Associations of Pennsylvania, Inc. Owner of the *Penn Radio & Sound Co.*, of Pittsburgh, Bregenzner has been very active in state and national service programs for many years.

Other officers elected to guide the federation during the coming year include Charles A. West of *West Television*, Williamsport, vice-chairman; Adam Deets of Edwardsville, recording secretary; Dan Holter of Bellefonte, corresponding secretary; and L. B. Smith of Hershey, treasurer. -30-

**ASSISTANCE REQUESTED**

**WE HAVE** received an urgent request from Pergamon Institute of London for help in securing a complete file of **RADIO & TV NEWS** from its inception in 1919 to the end of 1957.

The Institute is a non-profit foundation for the furtherance and dissemination of scientific knowledge, with headquarters at 4 & 5 Fitzroy Square, London, W1, England.

Since the publishers of this magazine are no longer able to supply back issues prior to 1953, we wonder if some of our readers would be willing to help out. The Institute will pay for back issues but asks that our readers write to the Administrative Secretary, R. Bigwood, listing the issues they have to offer. Please do not ship the issues until the Institute has indicated its need for them.

All transactions and financial arrangements will be between the Institute and the seller. Please do not send your letters or your issues to this magazine since we are not in the market for back issues of our publication. Thanks for your help. -30-

Research prototype model of new ultrasonic dishwasher is demonstrated here by Acoustica Associates' president, Robt. Rod. The new noiseless machine will clean dishes in seconds by means of "silent sound." The machine, which may sell for about \$500, is expected to be made available perhaps this year.

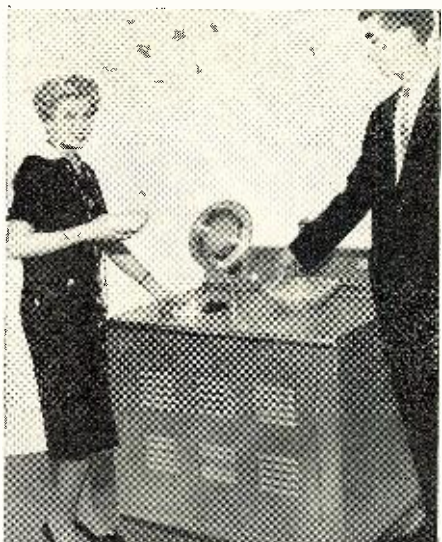

**The Gremlin Sentry**  
 (Continued from page 51)

that yells its head off when it gets wet. There are various difficult and expensive ways of building such a unit. The easiest way is to convert your pet gremlin. Fig. 3 shows the circuit changes. The sensitive element is composed of two small squares of metal window screening separated by a single thickness of newspaper. When dry, the paper is a fairly good insulator; but when wet, it is a better conductor than the 100,000-ohm bridge resistor. One drop of water striking the paper will unbalance the bridge and close the relay. If this makes the unit too easily tripped to suit your needs, move the pot tap closer to A. By adjusting the potentiometer, sensitivities from one drop to a cloudburst may be obtained. When the proper setting is found, remove the pot, measure the resistance from the tap to each end, and replace it with two fixed resistors. Now connect the output of the control relay to the primary of a doorbell transformer. The secondary, of course, is connected to a doorbell. This completes the rain alarm.

Upon introducing this gremlin to your wife, you will automatically become her great, big hero. With this sentry standing guard, she can hang out the wash on a cloudy day and then relax with her favorite television program. The first few raindrops will sound the alarm, telling her to bring in the wash, close the windows, etc.

One last word of caution: An isolation transformer will be worth its weight in gold for this application, since mixing water with a direct power-line connection can lead to shocking consequences. The author is deadly serious when warning you that ordinary 117-volt home power wiring can really send you—right out of this world! Since you're probably not an angel, there is no use rushing to the hot reception waiting for you.

**EDITOR'S NOTE:** And now one final word concerning the availability of the Simmons Electronic Blanket Control which forms the basis for this article. When the author first conceived the idea of seeing what he could do with the unit, many thousands of the controls were readily available at any one of a dozen electronics parts suppliers throughout the country. As we go to press, however, we have been able to locate only one source that has a large supply of the units on hand. The source is Concord Radio Corp., 45 Warren St., New York 7, N. Y.

Our readers who cannot obtain one of the blanket controls for conversion need not despair, however. We suggest that these readers simply follow the schematic diagram and parts listing given in the article. Note that the thyatron tube and resistor  $R_2$  are not required. -30-



**A**... Always  
**B**... Buy  
**C**... Columbia

Before you take another breath send for our NEW, sensational Summer '58 CATALOGUE, FREE!

**BUILD YOUR OWN BATTERY CHARGER!**  
 It's here! The famous GN-52 GENERATOR as used in Sig. Corps PE-2101 12-15 VDC output @ 30 amps. Small as a car generator! Runs from a fan belt, AC motor or gas pump. Excellent cond. While they last. **\$7.95**

**MOTOROLA FM MOBILE R-237/VR RECEIVER.** 30-40 MC. 6 VDC. 15-tube, double superhet! Looks like standard Motorola mobile installation. Size: 15x10x11". Excellent, like new. Complete with all tubes & self-contained power supply **\$19.95**

**COMMUNICATION RECEIVER**  
 Navy Model RBS-2. Freq. 2-20 MC. AM in 4 bands. All controls and dial on front panel. 115 V. 60 cyc. THIS IS A REAL P.B. RECEIVER at a real knock-down price! Excellent cond. With power supply. **\$39.50**

**FM FIXED STATION**  
 This is the Fred M. Link Transceiver. Freq. 30-42 MC. Power input 115 V. 60 cyc. Excellent condition. Complete w/ all tubes and self-contained power supply. **\$19.95**

**BC-683 RECEIVER**  
 27-38.9 MC. 10 tubes. Continuous and push-button tuning on 10 pre-set channels. Complete with 10 tubes, speaker, and squelch circuit. R.F. gain. Like new **\$14.95**

**BC-603 RECEIVER.** Same as above except freq. is 20-28.5 MC. Like new. **\$5.95**

**POWER SUPPLIES**  
 110 VAC. 60 cycles power supply for EITHER above BC-683 or BC-603 Receiver. New mfr. May be plugged into dynamotor receptacle on receiver. RECEIVER DOES NOT REQUIRE ANY CONVERSION W/ THIS V. Power supply interchangeable with dynamotor for 12 V. use **\$11.95**

AVAILABLE in kit form with instructions. **\$7.95**

**BC-134 TRANSMITTER**  
 12 V. Input power. 700 watts. Freq.: 1500 to 12,500 kc. Self-contained modulation. Can be used for CW or phone. Excellent, like new. **\$14.95**

**BC-1335 RECEIVER-TRANSMITTER**  
 27-38 MC. 120-channel FM. This is an 18-tube, small size, crystal controlled unit! Terrific for mobile installation. Has 6 or 12 V. SELF-CONTAINED power supply. Brand new. Complete with all tubes and vibrator. **\$19.95**

ONLY **\$1.25**

**SPARE VIBRATOR:** for this unit. New. **\$1.25**

All Orders FOB Los Angeles. 25% deposit required. All items subject to prior sale. NOTE: MINIMUM ORDER \$3.00. WRITE TO DEPT. R.

Columbia

**ELECTRONICS**  
 2251 W. WASHINGTON BLVD.  
 LOS ANGELES 18, CALIFORNIA

**THAT'S A BUY!**

New most famous make full wave bridge rectifier 130VAC factory rated 350Ma/100VDC gtd output up to one-half amp 20 plates 4-5-1; newly mfgd for gov't cont. Cost \$8.10, "TAB" Special \$1.25@, 5 for \$5 postpaid 48 States.

111BJ LIBERTY ST., N. Y. 6, N. Y.  
 Write for Catalog  
 PHONE: RECTOR 2-6245



**Genuine OAK WOOD  
 Antique  
 TELEPHONES!**

As is \$9.00 complete. Tested working order \$12.00. Shipments FOB Simpson, Pa. Write for free list.

Telephone Engineering Co.  
 Dept. RT6 Simpson, Pa.

**RADIO & TV NEWS  
 HAS A BUYER  
 FOR YOUR USED  
 EQUIPMENT**

If you have equipment, components, of parts to sell, look to the classified columns of RADIO & TV NEWS for fast results.

Your message, placed in our classified columns, will be read by more than 245,000 readers.

Best of all, your classified ad need cost you no more than \$5.00.

For further information, write:

Martin Lincoln  
 RADIO & TV NEWS  
 One Park Avenue  
 New York 16, N. Y.

**Universal Test Leads**  
 (Continued from page 52)

around the outside for a firm bond. F is a spade lug (with or without an insulator) for taking readings from binding posts. Attach the banana plug by soldering its stud to the spade lug. G is a universal battery clip (with or without insulator) for most temporary connections. Attach banana plug as in A.

These are but a few suggested possibilities for making up attachments. You will find many other combinations to solve your own particular problems as they arise. Once you have converted your test leads, many variations will suggest themselves.

As for switching terminations this may be done in a jiffy. Fig. 4 shows an alligator clip ready to be slipped into place on a prepared insulated handle. Different terminating connectors are on or off in a moment. -30-

Fig. 4. Any connector plugs in quickly.

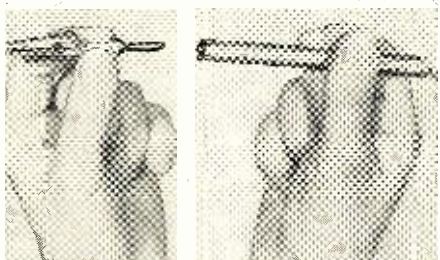

**FERRITE-ROD ANTENNAS**

By CHARLES ERWIN COHEN

ON AM RADIOS using ferrite-rod antennas, as do many nowadays, placement of this unit may have quite a bit to do with sensitivity of the receiver. On the popular Trav-Ler Model 5300 portable, for example, the ferrite-rod antenna is supported very close to the chassis. It was found that its effectiveness was quite low in this position. Temporarily dismantling it and supporting it as far away from the set as its leads would allow enabled clear reception on stations that could not even be heard when the antenna was in normal position.

As a result, the antenna was permanently mounted on the outside of the top surface of the back cover, adjacent to the handle, permitting the antenna to operate at full efficiency while preserving the compactness of the set. When a change of this kind is made, the antenna circuit will have to be realigned. The low-frequency adjustment is made by sliding the movable coil along the ferrite rod. This should be done before the antenna is mounted, as this adjustment will determine the position for the slots that will be cut into the back cover, or other accommodation that is made for the terminal lugs.

To determine whether your set will benefit from such a change, test it by removing the antenna from its mount and holding it as far away from the chassis as you can to compare the difference in performance. Hold the antenna lightly by one end of the rod, as too much hand capacity can damp out the coil.

-30-

**SEE BELOW—  
 UNCONDITIONAL  
 MONEY-BACK  
 GUARANTEE from**

**TRANSVISION**

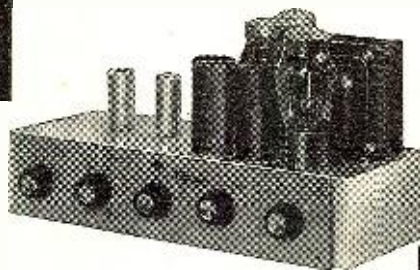

For the FIRST time—

**"STEREO"**

from

**ORDINARY RECORDS  
 RADIO, or TAPE**

The TRANSVISION "Dual-AMP" Stereo Amplifier (includes pre-amplifier) enables you to enjoy Stereophonic Music from ordinary records, tapes, or Radio. (May be used also for Stereo tapes and records since it is a high quality dual channel amplifier.)

You need only an ordinary record changer or tuner and speakers to do this.

**No Other Amplifier Required**

**SPECIAL INTRO-  
 DUCTORY OFFER: \$89**

Includes built-in preamp.  
 Regular price will be \$139.

**TECHNICAL CHARACTERISTICS:**

- (1) 24 watts total power—(2) Flat response 20-20,000 cycles—(3) Variable frequency responses on each section of amplifier allows compensation for all records—(4) Four inputs for phono, tuner, tape, TV—(5) Tube complement; 3-12AU7, 1-6SL7, 1-5U4G, 3-6V6—(6) Two output transformers—(7) Two speaker outputs—(8) Shipping weight, 19 lbs.

**MONEY-BACK GUARANTEE**

If returned in original condition within 10 days, the full purchase price less 15% handling and re-packaging charge, will be refunded.

TRANSVISION, INC., NEW ROCHELLE, N. Y., Dept. N

- I'm enclosing \$10.00 deposit. Ship COD.
  - Full payment enclosed; ship freight prepaid.
- Please ship one Transvision Stereo "Dual-Amp."

Name.....  
 Address.....  
 City..... State.....



# STEREOPHONIC KIT

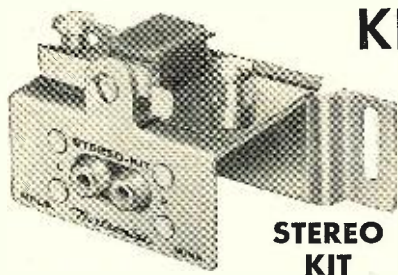

**STEREO  
KIT**

CONVERT to the NEW four-track stereo system. Mounts on existing monaural or stereo recorders and provides faithful reproduction of the new four-track prerecorded stereo tapes—as well as the presently available stereo and monaural tapes. Includes Nortronics TLD-H four-track head. To convert monaural recorders, one additional sound channel is required—such as the Nortronics PL-100 playback amplifier. Stereo recorders may be converted by either replacing the present head with a TLD-H head—or by using the STEREO-KIT (SK-40). Four-track prerecorded tapes are commercially available.



The TLD-H head and STEREO-KIT may also be used for stereo or monaural recording. For stereo recording use two Nortronics RA-100 recording amplifiers. Also available, is the two-track STEREO-KIT (SK-100), which contains the TLD-S head—suitable for converting monaural recorders to two-track stereo. Both the PL-100 and RA-100 may be used with the SK-100 kit. Information and circuits available. See your dealer or order direct. Net Prices: SK-40—\$26.00; SK-100—\$23.50; PL-100—\$39.50; RA-100—\$48.50; TLD-S—\$19.50; TLD-H—\$21.60.

**THE NORTRONICS COMPANY, INC.**  
1015 So. 6th St. Minneapolis 4, Minn.

**ENGINEERING DEGREES**

E.E. Option Electronics or Power

Earned through Home Study  
Residence classes also available  
(Operating as a College of Engineering  
only at present)

**PACIFIC INTERNATIONAL UNIVERSITY**

5719R Santa Monica Blvd.  
Hollywood 38, California

**SELF-SERVICE TUBE TESTERS**  
**\$25 TO \$50**

Used-reconditioned complete with signs and floor model cabinets. Get into a profitable business with a minimum investment. Write, Ed Moerke, P. O. Box No. 264, Zion, Ill.

**ELECTRONICS**

**PREPARE FOR A GOOD JOB!**  
**BROADCAST ENGINEER**  
**RADIO SERVICING AUTOMATION**

**TELEVISION SERVICING**  
**BLACK & WHITE—COLOR**

APPROVED FOR VETERANS AND SURVIVORS  
OF VETERANS  
BUILDING AIR CONDITIONED  
SEND FOR FREE LITERATURE

**BALTIMORE TECHNICAL INSTITUTE**  
1425 EUTAW PLACE, BALTIMORE 17, MD.



"AUTO RADIO REMOVAL" by Sams Staff. Published by *Howard W. Sams & Co., Inc.*, Indianapolis, Ind. Vols. 2 & 3 (1956-1957). Price \$2.95 each. Spiral bound.

These two additions to the series started last year with coverage of 1955 auto radio receivers include step-by-step instructions for the removal of radios, power supplies, and speakers from automobiles.

As was the case with the preceding volume, there is a list of tools required for removing each set, a phantom view of the dashboard panel with the radio in place, and a photograph of the radio in the process of being removed. The rear-seat speaker data provided for each model indicates whether or not there is a cut-out provided, the size speaker needed, and if a separate speaker control must be installed or is a part of the receiver.

Sets used in all of the most popular cars are included, hence for the technician specializing in auto radio servicing these volumes would seem to be an essential part of the workshop library.

"TELEVISION IN SCIENCE AND INDUSTRY" by Zworykin, Ramberg & Flory. Published by *John Wiley & Sons, Inc.*, New York. 289 pages. Price \$10.00.

If any author or group of authors was well qualified to write on the subject of closed-circuit television this trio should top the list. Dr. Zworykin is one of modern TV's outstanding pioneers, having invented the iconoscope and developed the kinescope. Dr. Ramberg is Research Physicist for *RCA Laboratories* while Mr. Flory is on the technical staff of the *Laboratories* specializing in the development of industrial TV equipment. These men have pooled their "know-how" with the result that a more authoritative book on this subject would be hard to find.

The authors cover a little of the historical background of CCTV and then discuss the fields in which such equipment is or can be used. Another section of the text deals with the equipment currently available, special techniques, accessories, etc. The balance of the book is devoted to an analysis of the achievements of closed-circuit television and its future applications.

It would be hard to pinpoint any facet of our economy that is not, cannot, or will not eventually be involved in closed-circuit or industrial TV—so wide are the ramifications of this versatile tool. The book is written in simple enough language so that

laymen and technical personnel in fields other than electronics can derive maximum benefit from the discussion.

"VACUUM TUBE RECTIFIERS" by A. Schure. Published by *John F. Rider Publisher, Inc.*, New York. 78 pages. Price \$1.50. Paper bound.

This is Volume 21 of the Electronic Technology Series. Coverage includes physical characteristics of rectifiers, single-phase rectifiers, polyphase rectifiers, output filter circuits, and rectifier and filter design data.

Theory and circuitry are given for half-wave and full-wave rectifiers, voltage-multiplying circuits, polyphase rectification, and filter circuits.

The book also includes tables of tube characteristics to supplement the text.

"WHAT MAKES GUIDED MISSILES TICK!" by Barron Kemp. Published by *American Electronics Co.*, 1203 Bryant Ave., New York 59. 95 pages. Price \$1.50. Paper bound.

This book describes the construction and uses of guided missiles and satellites in simple, clear, everyday language. The chapters include information on guided missile history, modern guided missiles, missile electronics, telemetering, the satellite, the missile's future, a glossary and other data which will give the layman as well as the technician an understanding of the over-all picture of guided missiles and satellites.

"LOW-COST HIGH-QUALITY AMPLIFIER" by P. J. Baxandall. Published by *Iliffe & Sons Ltd.*, London. 29 pages. Price 3s/6d (by mail 4s). Paper bound.

This text consists of a series of articles which originally appeared in recent issues of "Wireless World." The author feels that many of the dicta of "high-fidelity experts" are based on hearsay rather than fact. A statistical analysis by the designer of the power amplifier described in this booklet has shown that an undistorted output of more than 5 watts is rarely called for, even by sound-reproduction enthusiasts when given a free hand to adjust the volume level to their own liking.

The booklet describes a low-cost high-quality amplifier, a low-cost preamplifier, and a phono and mike preamplifier.

"PORTABLE TRANSISTOR RECEIVER" by S. W. Amos. Published by *Iliffe & Sons Ltd.*, London. 15 pages. Price 2s/6d (by mail 2s/10d). Paper bound.





# Name your own 7 WONDERS OF THE WORLD

and visit them all

FREE VIA **TWA**  
TRANS WORLD AIRLINES  
U.S.A. • EUROPE • AFRICA • ASIA

Just list any 7 places, people, or events in the world that you would most like to visit and photograph, and you can win this fabulous contest!

TWA-TRANS WORLD AIRLINES will fly you to the 7 world wonders of your choice in luxurious comfort aboard a JET-STREAM\* airliner!

AMERICAN EXPRESS will make all arrangements for first class accommodations through its worldwide Travel Service! Your expenses will be covered by safe, convenient, American Express Travelers Cheques, spendable everywhere!

POPULAR PHOTOGRAPHY magazine will reveal how you can get aboard this exotic magic carpet when it announces full details of the most unique contest ever—in the July issue.

Read complete details in July  
**POPULAR PHOTOGRAPHY**  
... on sale June 3

\*JETSTREAM IS A SERVICE MARK OWNED EXCLUSIVELY BY TWA

This is a reprint of an article which originally appeared in "Wireless World" covering the construction of a transistorized superhet.

The booklet describes the theoretical and practical design of a battery operated, self-contained portable set which uses a total of seven junction transistors and one point-contact diode.

The receiver operates from a 4.5- or 6-volt drycell which will provide 150 hours of listening for a nominal sum. A built-in ferrite rod antenna and the use of the latest type of r.f. transistors gives this receiver exceptionally high sensitivity.

U. S. readers are advised that the component parts used in this construction are of British manufacture and American-built equivalents may not be available in all cases.

\* \* \*

"FEEDBACK THEORY AND ITS APPLICATIONS" by P. H. Hammond. Published by *The Macmillan Company*, New York. 344 pages. Price \$7.00.

Written for post-graduate engineers and physics students as well as practicing engineers in need of a brush-up, this volume covers proven methods of linear and nonlinear feedback system analysis and their application to engineering devices which incorporate feedback in some form.

The author has assumed that the student has some familiarity with the Laplace or Heaviside operational method and the reader is advised to have his working knowledge of mathematics well in hand before tackling this text.

Since the author is Principal Scientific Officer of the Royal Radar Research Establishment at Malvern, England, some of his terminology is British but should involve no difficulties on this score for those accustomed to finding their way around the literature.

\* \* \*

"FUNDAMENTAL PRINCIPLES OF TRANSISTORS" by J. Evans. Published by *D. Van Nostrand Company, Inc.*, Princeton, N. J. 249 pages. Price \$6.75.

This book has been written by an engineer with the *Standard Telecommunications Laboratories*, Enfield, England and is intended for practicing engineers or students at the post-graduate level.

The text is divided into eleven chapters covering an introduction to transistors, basic theory of semiconductors, the measurement of semiconductor parameters, the theory of the *p-n* junction, the methods of preparing a *p-n* junction, point-contact transistors, junction transistors, measuring transistor parameters, the manufacture of transistors, special types, and silicon and other transistor materials.

The treatment is mathematical and makes no concessions to those with a weak background in physics, mathematics, and electronics. Engineers and specialists in metallurgy and chemistry will derive the most benefit from this work.

## RADIO ELECTRONIC SURPLUS

### BC683 FM RECEIVER



27-39 mc. Equipped with 10 push buttons for selecting channels. Cont. variable tuning over the entire range. Unit complete with tubes, built-in loud speaker, squelch circuit, head phone jacks, schematic diagram on bottom of case. Approx. weight 34 lbs.  
Used, good.....\$12.50 each  
12- or 24-volt D.C. Dynamotor.....each \$3.95

### BC603 FM RECEIVER

Same description as BC683 except that range is 20-27 mc. This unit complete with tubes.  
Like New.....each \$6.95  
Manual with schematic for BC603 & BC604.....\$1.00 each

### BC684 TRANSMITTER

(Used with BC683 receiver.) Used, good...\$4.95 each  
CRYSTALS (set of 80) for BC604 transmitter..\$5.00

### DM35 DYNAMOTOR

Input 12 volt D.C., 18.7 amps. Output 625 volts, 225 ma. Used, good.....\$12.50 each  
FT237 RACK for above receivers and transmitter.....\$4.95

### BC1335 2-CHANNEL

#### FM TRANSCEIVER



30-39 mc. This unit is complete with 18 tubes operating from either 6 or 16 volts D.C. (Self-contained power supply). Crystal control, sensitive superhet circuit. Approx. dimensions 11" x 10" x 6". Approx. weight 24 lbs. Unit complete with tubes, schematic diagram and pre-setting instructions.

Like New.....each \$22.50

### BC659 FM TRANSCEIVER

29-40 mc, 2 channels, crystal control. Unit complete with tubes, built-in speaker and dual meter for testing filament and plate circuit. Approx. dimensions 16" x 13" x 7 1/2".

Like New.....each \$6.95  
Power Supply (PE120) for BC659 operates on 12-volt D.C.  
Like New.....each \$6.95  
Manual with schematic for BC659.....each \$1.00

### NT-6 WILLARD 6-VOLT STORAGE BATTERY



Rated 2.4 amp. hr.  
Approx. dimensions: 3 1/2" x 1 3/4" x 2 1/8" h.  
Weight: 1 lb. 3 oz. (plastic case) Dry charged  
PRICE \$2.50 ea.

### 500 KC CRYSTALS IN FT241 HOLDER

(54th harmonic type).  
\$1.00 each,  
6 for \$5.00 postpaid

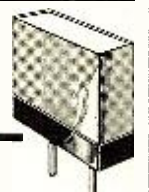

### AN/CRC-7 VHF TRANSCEIVER



With voice or transmit tone, used with air-sea rescue work. Crystal controlled. 140.58 mc. Used, good.  
See Conversion Data April '58, CQ

\$15.00 each (less battery)

### 44 POSITION STEPPING SWITCH



With automatic reset. 24 volt A.C. Dimensions 4 1/4" x 4 1/4" x 3" deep. Mfgd. by Wico.

\$3.00 each

Five for \$12.50 postpaid

RG-8/U (52 OHM) 100 FT. Roll With Connectors.....\$5.95 per roll

RG-11/U (75 OHM) 200 FT. Roll With Connectors.....\$7.95 per roll

NO C.O.D.'s. REMIT FULL AMOUNT WITH ORDER. ALL PRICES F.O.B. PASADENA.

**C & H SALES CO.**

2176 E. Colorado St. - Pasadena 8, Calif.



**CHRISTMAS IN JUNE!**



**SEMI-ANNUAL  
DOUBLE  
BONUS  
OFFER!**

**BONUS #1**  
Your choice  
of any  
**POLY-PAK®**  
Listed Below

**BONUS #2**  
Our Choice  
**\$5 WORTH**  
Assorted  
**RADIO PARTS**

**BOTH FREE WITH \$10 ORDER!**

UNTIL JUNE 30  
Our Usual \$1  
**POLY-PAKS®**

**88¢**  
EACH

- 100 CERAMIC CONDENSERS, 2 lbs.
- 30 DISC CONDENSERS, 2 lbs.
- 40 PRECISION RESISTORS, 1 lb.
- 10 TIMING MECHANISMS, 2 lbs.
- WIRE STRIPPER-CUTTER.
- 7 SCREWDRIVERS w/ RACK.
- 60 HI-Q RESISTORS, 1 lb.
- PIC TUBE BRITENER, Parallel.
- 20 FERRITE TUNED COILS, 2 lbs.
- 5 BALLPOINT PENS, 1/2 lb.
- 50-FT. "ZIP" CORD, 2 lbs.
- 5 25' ROLLS "MICRO" WIRE.
- 250-FT HOOKUP WIRE, 3 lbs.
- 1 1/2 1/60 FAN MOTOR.
- SIGMA 10,000 ohm RELAY.
- MEN'S CIGARETTE LIGHTER.
- 40 MOLDED CONDENSERS.
- 150 RESISTORS, 2 lbs.
- 2 TRANSISTOR XFMRS.
- 2 PRINTED CIRCUITS.
- 4 G-E 1N69 DIODES.
- 6 AC-DC CORD SETS
- 5 DIAL-LITE ASSEMBLIES.
- VEE DER-ROOT COUNTER, D-9999.
- 40 TUBE SOCKETS, 2 lbs.
- MIDGET CRYSTAL MIKE.
- 4 POWER FILTER CHOKES, 2 lbs.
- "MICRO" MOTOR, 1 1/2 VDC.
- 20 RAYTHEON KNOBS, 1 lb.
- 6 TRANSISTOR SOCKETS.
- 1000 PCS. HARDWARE.
- 6 SILICON DIODES.
- 8 GERMANIUM DIODES.
- 10 POWER SWITCHES, asstd.
- 50 PRINTED CIRCUIT PARTS
- 60 COILS & CHOKES, 2 lbs.
- 2 SUB-MINI SOLENOIDS, 2 oz.
- 20 VOLUME CONTROLS, 2 lbs.
- 15 ROTARY SWITCHES, 3 lbs.
- 50 PLUGS, RECEPTACLES, 2 lbs.
- 6 FERRI-LOOPSTICK CORES, 1 1/2 lbs.
- SUN BATTERY, hundreds uses.
- 40 POWER RESISTORS, 2 lbs.
- 60 TUBULAR CONDENSERS, 2 lbs.
- 60 TERMINAL STRIPS, BOARDS.
- 1 MINI-METER, 1 1/4 lbs.
- 40 HI-Q CONDENSERS.
- 8-PC. NUTDRIVER SET
- TV MIRROR, 1 lb.
- 50 ASSORTED KNOBS, 2 lbs.
- 10 "POLY" BOXES.
- 100 RADIO PARTS, 3 lbs.
- 75-PC. RESISTOR SPECIAL, 2 lbs.
- 2 PNP TRANSISTORS.
- 65-PC. CONDENSER SET
- 70 MICA CONDENSERS, 1 lb.
- 15-PC. TWIST DRILL SET
- 40 SUB-MINI RESISTORS.
- 10 ELECTROLYTICS, 3 lbs.

**Mac's Service Shop**  
(Continued from page 62)

"And it's a handy-dandy little a.c. field detector," Barney went on as he held the pickup within about three feet of an electric clock on the wall. The straight line on the scope screen wrinkled up into a very distorted sine wave as Barney adjusted the sweep to sixty cycles. "Using this thing as a probe, you can tell where a magnetic field is strongest and weakest. That often helps in placing transformers, discovering how hum is getting into a phono pickup, etc. And, by looking at the scope, you can tell the nature of an unknown field and make a shrewd guess as to what is producing it."

As he finished speaking, Barney disconnected the pickup from the scope and connected it to the input of the a.c. v.t.v.m. The range switch was set to .01 volt full-scale.

"I want you to see how sensitive this arrangement is to any pulse produced field," Barney said as he picked up a metal-cased flashlight and held it near the pickup. Every time it was switched on, the meter pointer jerked smartly. "Give you any ideas?" he asked.

"Yeah. That arrangement could be very handy in locating an intermittent or poor connection, especially in any sort of transformer winding. With d.c. passing through the winding, the slightest variation in current would show on that meter."

Barney looped a test lead from the ohmmeter carelessly around the pickup and touched the prods together. Even though the ohmmeter was on a range that sent one milliampere of current through the leads, the meter kicked every time the prods touched each other. "Just wanted to show you how sensitive the thing is," he explained. "You can detect a very small change in current through even a single wire lying against the pickup and you can do it without making any direct connections to the circuit. Of course, if you want to hear what the pickup is getting instead of seeing it, all you have to do is connect it to the high-gain input of the signal tracer."

"I'm sold," Mac said with a grin; "you've just invented a new probe." Barney started to speak and then stopped. Finally, though, he looked up at Mac sheepishly and said:

"I didn't intend to tell this on myself, but after your confession I think I'll tell you my experience with that blessed scope. When I was cleaning up the bench the other day I noticed the transparent screen in front of the tube had collected a lot of finger smudges; so I took it out of the bezel and gave it a good washing, wiped it dry with a clean paper towel, and replaced it. Wanting to see how much difference this made, I switched on the scope. When no trace appeared,

I increased the intensity, double-checked the positioning controls, fiddled with the focus control, and made sure both amplifiers were turned clear off; but not the slightest trace of a spot or pattern could be seen.

"Man, I was really sweating, for I was convinced that somehow I had clobbered your scope. I couldn't make up my mind whether to join the Foreign Legion or volunteer to be the first man shot to the moon! To see if I could detect any sign of fluorescence, I turned out all the shop lights and removed the calibrated screen again. There was the trace just as nice as you please!

"It didn't take me long to discover that when I tried to replace the screen in front of the tube the trace would slide off to one side like a glob of mercury under a finger tip. That transparent screen was carrying a king-size static charge, doubtless induced by the brisk rubbing with the paper towel. The nasty part was I couldn't get rid of the charge. I tried rubbing it all over with my hands, holding it under running water, and squeegeeing it on the metal bench; but the more I did the more charge it seemed to collect. It picked up lint and dust and began to look as though I was trying to tar and feather it. Finally I got an inspiration: I rubbed it with the anti-static cloth we use on records, and that did the trick. I was sure glad to be able to see that trace again *through* the screen!"

"I had exactly the same experience," Mac chortled, "but I never thought of the cloth. I just waited until the charge leaked off and that took a long, long time.

"Much as I hate to break up this Kaffeeklatsch, it's really time we got to work, Red."

**ARRL MEET IN FRESNO**

**THE Fresno Amateur Radio Club of Fresno, California, will play host to the Pacific Division ARRL Convention on June 7th and 8th.**

Harry Engwicht, W6HC, Pacific Division Director, and George Hart, WINJM, national emergency coordinator, will be honored at the wind-up banquet.

The committee in charge has scheduled open forum discussions, commercial displays, entertainment, and a "Wouff Hong" initiation. Special technical sessions will be held by groups, including SSB, RTTY, VHF, Novice, and Traffic.

The Hotel Californian has been chosen as official headquarters with 125 rooms set aside for the convention.

The ticket price for the two days is \$7.75 including the banquet. Pre-registrations should be postmarked no later than midnight June 2nd.

XYL's and YL's are cordially invited. Special activities have been planned for the ladies—including a luncheon and organized tour.

Outside activities will include mobile judging and hidden transmitter hunts on 75, 10, 6, and 2 meters.

Reservations and all correspondence regarding the meet should be addressed to Radio Amateur Convention, P.O. Box 783, Fresno, California.

**FAMOUS Regency**  
ALL-TRANSISTOR Vest Pocket  
**RADIO only \$14.95**



Lektron scoops the field with the "hottest" pocket transistor radio since the advent of the transistor! Designed and built by Regency, one of America's great names in radio. Uses an exclusive circuit with RF, DET and AMP stages. **SMALLER THAN A PACK OF CIGARETTES!**—only 3x2x1 1/2". NO EXTERNAL ANTENNA OR GROUND—no hanging wires! Amazing sensitivity, volume and selectivity. Attractively designed two-tone styrene case. Variable tuning covers 540 to 1500 kc. **READY TO PLAY** when you receive it! 1000-hour batteries and ultra-sensitive phone included in this fabulously low price! Gift packed. Wt. 1 oz.

**THREE-TUBE AC-DC AMPLIFIER**  
 Fully wired, ready for use. Reg. \$5. Separate volume and tone controls. Lowest price ever! **\$2.99**  
TUBES: \$1.01 extra

**HI-FI 10" SPEAKER**  
 40 to 10,000 cycles. Famous make. 8-ohm v.c. Hvy Alnico magnet. Wt. 3 lbs. **\$4.44**

**HOW TO ORDER** Check items wanted. Return entire ad w/ check or M.O. including sufficient postage; excess returned. C.O.D. orders, 25% down; rated, net 30 days. Print name, address, amount money enclosed, in margin. (Canada postage, 45¢ 1st lb., 28¢ ea. addl. lb.) EXPORT ORDERS INVITED.

**POCKET TRANSISTOR**

3 1/2 x 2 x 1 1/2" bakelite case. 100 ohms/volt. Zero adj. 0/15/150/1000 AC & DC V: 0/150 ma; 0/100,000 ohms. W/test leads & battery. **\$6.99**  
\$12 value.





# What's New in Radio

## 100-WATT MOBILE RADIO

The Communication Products Department, *General Electric Company*, Electronics Park, Syracuse, N. Y., has announced the availability of a thermostatically protected, transistor-powered 100-watt mobile radio.

The new equipment is designed with automatic cut-off and re-set functions which keep the transistor power supply safe from abuse due to heat caused by overload, duty cycle, and environmental conditions. The unit is equipped with a die-cast heat sink of special design. Made of brushed aluminum, the sink resembles a waffle grid and serves as a total enclosure for power transistors. With this design the equipment can be operated in any position with the grid providing a chimney effect for heat elimination.

This mobile is designed for operation in the 25-54 mc. band.

## WIREWOUND POT

*Eastern Precision Resistor Corporation*, 675 Barbey St., Brooklyn 7, N. Y., has developed a new subminiature precision wirewound potentiometer that provides infinite resolution.

Tradenamed the "I.R. Potentiometer," the design represents an entirely new approach to the problem of obtain-



ing infinite electrical and mechanical resolution in ultra-small pots. The unit is completely sealed by a double-walled case that withstands all environmental conditions. The problem of vibration and shock is eliminated because no wiper arm is employed. The 100% usable resistance range allows for adjustment from zero ohms to full resistance with  $\pm .1\%$  tolerance.

Further details on this unit are available direct from the manufacturer.

## TV KIT BUILDER

*Brooks Radio & TV Corp.*, 84 Vesey St., New York 7, N. Y., is now offering a deluxe TV chassis in kit form for the "do-it-yourself" contingent.

Capable of driving any 70- or 90-degree CRT in 17, 21, 24, or 27 inch sizes, the circuit incorporates 16 tubes and provides 30-tube performance. Other features of the DX-16 include: intercarrier circuitry; cascode tuner for selectivity and fine definition; 5 $\mu$ v. video sensitivity; fast-action a.g.c.; three



## 60 NEW PROJECTS FOR "DO-IT-YOURSELFERS"

**IMPORTANT NEWS:** The new 1958 Edition of the *Electronic Experimenter's Handbook* is now on sale. If you like to build useful, profitable electronic devices, pick up a copy of the new *Handbook* now. Last year's edition sold so fast many hobbyists, experimenters, and students couldn't buy a copy . . . and this year's *Electronic Experimenter's Handbook* contains even *more projects, more pictures, more guidance!* Each device has been pre-tested and operated by readers of *Popular Electronics*. You'll find step-by-step instructions, hundreds of photos, drawings and unique "pictorial diagrams."

## 60 Devices . . . Nearly 200 pages . . . a Practical "File" of Electronics Ideas and Information

**FOR YOUR HI-FI.** Presence control. Hi-fi crossover. Filter. Electrostatic speaker system. Mixer equalizer. Spare amplifier. \$5 coax oval-flex speaker enclosure. Junior hi-fi. Hardware store crossover.

**RECEIVERS.** Shirt pocket transistor superhet. Vokar receiver. Superregen unit. Miniature VHF ear. Junkbox BC receiver. Etched circuit two-tuber.

**FOR YOUR HOME.** Invisible light door opener. Picnic power amp. DC supply for AC/DC motors. Installing back seat speaker. Light-operated relay. Transistorized intercom. Radio intercom.

**FOR YOUR DARKROOM.** Audio photometer. Transistor slave flash unit. Photographer's electric pencil. Light distributor. Darkroom timer. Enlarger exposure meter.

**FOR YOUR HAM SHACK.** Simple shortwave receiver. VHF explorer's receiver. 70-watt transmitter. Double your Heathkit AT-1 output. Code practice set. Antenna tuner. Transistor 10-meter receiver.

**FOR YOUR WORKSHOP.** Economy signal generator. Simple oscilloscope calibrator. Rejuvenator for dry cells. \$14 signal tracer. Transistor checker. Capacitor meter. Low-cost multi-tester. Transistorized signal tracer. Buzzer-type power supply.

**FOR THE KIDS.** IQ tester. Electronic worm digger. Model spaceship. Game computer. Transistorized phonograph amplifier. Coin operated oscillator.

**SPECIAL PROJECTS.** Solar battery experiments. Electronic anemometer. Varistrobe. Detectorscope. Simplified etched circuits. Car rattle locator. Simple burning tool.

**ON SALE NOW - Only \$1**

Buy Your Copy Today at Your Newsstand or Radio Parts Store

ZIFF-DAVIS PUBLISHING COMPANY, 434 S. Wabash Ave., Chicago 5, Illinois.



\$29.95  
ppd

Send for it today!

NEVER BEFORE AT THIS LOW PRICE!

Precision, battery-operated transistorized portable

## TAPE RECORDER

Weights only 2 lbs. 8"x7"x2"  
(imported from West Germany)

Precision-engineered—Records, plays back, erases. Variable speed controls. Operates on 4 ordinary C-batteries. Uses standard 1/4" 1-mil or 1/2-mil tape. Playback time about 15 min. Patented motor mount provides for forward and reverse winding; stopping with instantaneous braking action, taking up all slack tape; preventing tape from spilling. Voice can be dubbed and superimposed on music or other voice recording (and vice versa). Fine, durable, high-quality components. Complete instructions. Servicemen—Dealers! Every service call an easy sale after a simple demonstration. Imitates same functions as machines costing many times as much.

Your cost for sample, only \$29.95. Suggested retail selling price, \$39.95! On your re-order for two or more, earn an additional 10% discount. Hurry—be the first in your area with this sure-fire item! Everyone will buy! Rush order now!

Unconditionally guaranteed for 90 days against mechanical defects. 10-day money-back guarantee. RTN-6

**FILNOR PRODUCTS CO. 1 Park Ave., N.Y. 16, N.Y.**



## BLOCK-BUSTING BUYS FROM ARROW'S NEW CATALOG 117

Look at some random selections:

### MARINE:

New APN-4 B Loran, 12, 24, 32 volts Collins' TCS receiver with 12 Volt dynamotor tunes 1500 to 3000 kc on its first band and you can crystal control 4 channels, all for \$29.45 Bendix DF's Eclipse remote compass, complete new installation for \$49.50 Sportsman Transmitter-Receiver in Mahogany case, 54 Watts output and many more.

### AMATEUR:

Black Widow Mobile xmtr-rcvr in 1 1/4, 2, 6, and 10 meters for \$165.00 GO-9 GP-7 SCR-522 BC-1335 BC-583 BC-779 Hammarlund Super-Pro Command-Set units include 2-meters Tune-up and S-meter mikes handsets all at the lowest prices in the world

### HI-FIDELITY:

TWO power amplifiers on ONE chassis for Stereo OR Monaural, ready to use, and only \$49.50 Our own all-transistor 10 Watt power amplifier, kit or wired, uses NO output transformer, has ZERO ohms output impedance, matches everything; uses Zener controlled lab-standard regulated pwr supply, thermistor bias control, and gives the CLEANEST sound you ever heard, only \$49.50 for the kit; uses solder-dipped printed-ckt board for your wiring ease Our own Wall Baffles with HARTLEY speakers let you have BOTH Stereo AND your furniture too 3-motor Stereo Tape Recorder Pioneer speaker bargains and many, many more

AND EVERYTHING CAN BE BOUGHT WITH ONLY 10% DOWN and a year to pay.

Our new sales showroom at 7035 Laurel Canyon, No. Hollywood, Calif.

**FREE!** Hot off the press! Our new Catalog 117! Get your copy today!

**ARROW SALES, INC.**  
BOX 3007-RN NORTH HOLLYWOOD, CALIF.

## SCHEMATICS—CONVERSIONS FOR SURPLUS GEAR

### NEW LIST DI MANY ADDITIONS!

Send stamped, self addressed envelope for List D. Add 25c for chart explaining AN nomenclature. DO IT TODAY!

R. E. BOX 1220  
GOODHEART BEVERLY HILLS, CAL.

## a TERRIFIC BARGAIN in a

**SOLA CONSTANT-VOLTAGE TRANSFORMER**  
Ends fluctuating line voltage!

Big Discount Off...

the factory price at a 1-input 2,000 VA unit! And here's another bonus! This Air Forces 2,000 VA overstock, Sola Cat. No. 30768, has 4 inputs! 90-125 V., 190-250 V., 60 cy. or 50 cy. Isolated secondary is constant 115.0 V. ± 1% from no-load to full-load of 17.4 amp. So, if you choose, use it as a 220-115 V. step-down. And slash \$97.50 off the factory 1-input price!

Brand new in original wood box. 4 cu. ft. Ship. wt. 254 lbs. F.O.B. Pasco, Wash. Only **\$147.50**

**THE M. R. COMPANY**  
P. O. Box 1220-A Beverly Hills, Calif.



BC-652-A 2 to 6 mc.—two bands 8 tube super heterodyne receiver designed for A.M. or C.W.  
3 tube crystal frequency calibrator in receiver in separate chassis.  
C.F.C.—calibrates receiver, calibrates trans, oscill, stage on tunable freq. and presets freq.  
Contains DM-40 Dyn. operating on 12 volts D.C. input **\$29.95**  
Same as above but no Dynamotor... **\$24.95**

BC-344 Receiver—200-1500 KC 115 V.A.C. input. Exc. Cond. **\$39.95**

IU4 Jan Portable Battery Tube 4 for **\$1.00**  
Quant. of 100 or more less 10% + 2% for cash 100,000 Available

Versatile min. Transformer. 3 sets of C.T. Winding for a Comb. of impedance 600 OHMS C.T. \$20.00 OHMS 25,000 OHMS. The ideal Trans. for S.S.B. Phone Patch, etc. **65c**  
Price Reduced ..... 10 for \$5.00

### SPECIALS

Rotary Inductor Silver Plated.....\$5.95  
Plate Relay Shielded Sigsma.....\$4.95  
Jumbo Crystal Socket 50-200..... 4 for 1.00

### PANEL METERS—All New

3" Square 0-3 V.D.C. 20,000 OHMS P.V.....\$4.95  
0-15, 0-5, 0-6, 0-5, 0-2 Amps R.F.  
W/Ext. Thermocouple.....ea. 6.95  
Simpson 2" Sq. Scale Calif. 0-3 Volts and 0-10 Volts Peak to Peak..... 4.95

**SPARKS RADIO SUPPLY**  
194 GENESEE ST., BUFFALO 3, N.Y.

high-gain video i.f. stages; a.g.c. level and area control; pre-aligned video and i.f. coils; Synchroguide; 250-ma. power transformer; and 12" speaker.

The kit comes with all parts and tubes, except the picture tube. Full size step-by-step building instructions are included. The company also offers a line of build-it-yourself cabinets to house the chassis.

Write Dept. B of the company for full details.

### COMMUNICATIONS SYSTEM

Security Devices, Inc., P. O. Box 64, El Reno, Okla., is now in production on a new simultaneous communications system, the Model LCS-2.

The system, composed of from 2 to 20 stations, permits communication between all stations in the system without the necessity for operating switches or other controls, permitting personnel to

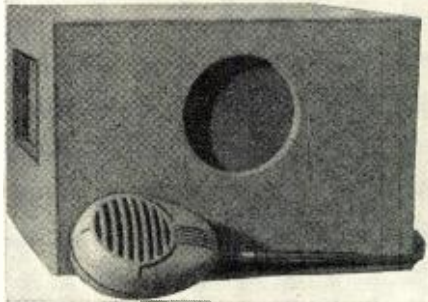

exchange conversation under emergency conditions or while engaged in other activities without hampering movements.

Each station is a master unit, consisting of a dual amplifier, loudspeaker, and microphone. The amplifier is housed in a non-metallic cabinet which is finished in an attractive and durable coating. The cabinet is fully enclosed and provided with a locked cover on the rear to prevent tampering, but is readily accessible for servicing.

The various units of the system are interconnected by a single two-conductor cable. All units are connected in parallel. The system is designed for continuous duty on a 24-hour basis. Power consumption will not exceed 50 watts at 117-volt, 60-cycle a.c.

The manufacturer will supply complete specifications and prices on request.

### FM MOBILE PHONE

Kaar Engineering Corporation, 2995 Middlefield Road, Palo Alto, Calif., has developed a new low-priced FM mobile radiotelephone that can be licensed for use by any citizen of the U.S. for communicating between vehicles and fixed points, from one vehicle to another, and between two or more fixed points.

The TF500FM operates in the 450-460 mc. special services and the 460-470 mc. Citizens Radio bands and is the lowest priced, commercial-grade instrument of its type yet to be placed on the market, according to the company.

Police and fire departments, railroads, taxicab operators, industries, and other specific commercial enterprises are eligible for licensing in the 450-460

mc. band while any citizen is eligible for licensing in the Citizens Band.

Under average conditions the new unit will provide reliable communications between vehicles and a fixed point

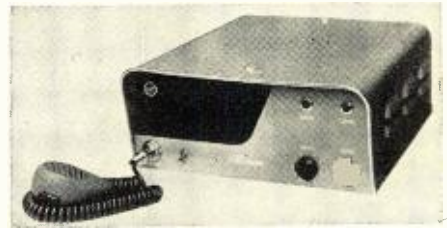

within a 10-mile radius of the fixed station. Detailed information on this equipment is available from the manufacturer.

### "CARDMATIC" TUBE TESTER

The Hickok Electrical Instrument Co., 10524 Dupont Ave., Cleveland 8, Ohio, is now offering a new high-speed, low-cost "Cardmatic" portable tube tester for service and maintenance applications.

The heart of the Model 121 is an automatic, card-type multiple switch that has an unusually low contact-to-pin resistance and an almost unlimited flexibility to virtually eliminate the obsolescence factor.

The test provides up to 140 fixed-bias potentials, 320 heater voltages, 640 plate voltages, 640 screen voltages, 100 self-bias settings, and 4000 quality-value sensitivity ranges to permit a



high degree of accuracy and completeness in testing all tube elements for exact evaluations.

The active card magazine holds over 600 code cards instantly available. For additional details on this tester, write the company for a free brochure.

### SIGNAL TRACER KIT

PACO Electronics Company, Inc., a division of Precision Apparatus Company, Inc., Glendale, New York, has introduced a new r.f.-a.f. signal tracer kit which has been designed especially for use by industrial technicians, service technicians, and hobbyists.

The Model Z-80 is capable of handling all receiver or amplifier signal levels, including direct tracing of the signal at the receiver antenna input terminals. The unit may even be used as a small paging amplifier.

Simple to assemble and use, the Model Z-80 features a high-gain amplifier for both r.f. and a.f. investigation, high sensitivity for the direct pickup of broadcast signals at the receiver antenna input terminals, fine and coarse







HQ for the 5 TOP QUALITY brands of

# TUBES

AT SENSIBLE PRICES!

• Individually Boxed • First Quality Only

0A2	.75	5Z6	1.60	6CU6	1.50	12AX7	.85
0A3/VR75	.80	6A7	1.35	6D6	1.20	12AY7	1.70
0B2	.75	6A8M	1.35	6DC6	.95	12AZ7	.95
0B3/VR-90	.80	6A8GT	1.35	6D3Y	.85	12BA6	.70
		6AB5	.75	6D7E	.85	12BA6	.70
0C3/VR-105	.80	6AB5	1.25	6DQ6	1.55	12BA7	1.25
		6AB7	1.50	6E5	1.00	12BE6	.75
0D3/VR-150	.80	6AC5GT	1.35	6E5	1.10	12BE6	.75
		6AC7	1.35	6F6M	1.35	12BF6	.75
0Z4	.75	6AD7G	1.85	6FGG	1.00	12BH7A	1.05
0Z4G	.70	6AF4	1.45	6H6	.75	12BK5	1.20
1A5GT	.90	6AF6G	1.20	6J4	2.00	12BN6	1.10
1A7GT	1.00	6AF5	.80	6J5	.85	12BQ6GT	1.55
1AD4	1.50	6A7	1.80	6J7	1.20	12BR7	.85
1AE4	1.35	6AH4GT	1.05	6J7	1.20	12BR7	.85
1AG4	1.50	6AH6	1.40	6K5G5	.80	12BV7	1.00
1AX2	1.00	6AK4	1.50	6K7	1.20	12C7A	1.05
1B3GT	1.00	6AJ5	1.85	6K8	1.40	12CZ7	1.05
1H5GT	.85	6AK5	.90	6L6C	1.50	12C5	.80
1L4	.75	6AK6	1.50	6L6M	2.00	12C6	.85
1L5	1.05	6ALS	.65	6L6M	2.00	12C6	1.55
1LA4	1.00	6AL7GT	1.80	6L7	1.40	12DQ6	1.55
1L6	1.00	6AM4	1.65	6S4	1.25	12K7GT	1.00
1LB4	1.25	6AM8	1.15	6Q7	1.10	12K7GT	1.00
1LC5	1.10	6AN4	1.65	6S4	1.25	12K8	1.30
1LD5	1.10	6AN8	1.20	6SA7GT	1.05	12Q7GT	1.00
1LE3	1.10	6AQ5	.75	6SC7	1.00	12SA7GT	1.05
1LG5	1.10	6AR6	1.20	6SB4	1.25	12S6	1.00
1LH4	1.10	6AQ7GT	1.15	6SF7	1.20	12S7	1.00
1LN5	1.10	6ARS	.75	6SG7	1.10	12SH7	1.00
1LSGT	1.05	6AS7	2.25	6H7	.85	12SK7GT	.95
1Q5GT	1.10	6ASS	.85	6S7M	.85	12SK7GT	.95
1RS	1.00	6AS6	1.00	6SK7CY	.90	12SL7G	.95
1S4	.80	6AS8	1.15	6SN7GT	1.10	12SN7GT	1.00
1S5	.80	6AT6	.75	6SQ7GT	.85	12SQ7GT	.85
1T4	.80	6AT8	1.10	6S7GT	1.00	12V6GT	.75
1T5GT	.90	6AU4GT	1.15	6SS7	1.05	12V6GT	.75
1U5	.80	6AUSGT	1.50	6ST7	1.10	12W6GT	1.00
1V	1.00	6AU7	1.00	6T8	1.15	12AA4	1.25
1V2	.65	6AUS	1.20	6U5	1.00	12AA5	1.60
1X2B	2.00	6AV5GT	1.20	6V6	1.00	12AF7	1.05
2A3	.55	6AV6	.60	6V3A	1.45	12AF7	1.05
2AF4A	1.35	6AWS	1.25	6V6GT	.75	14B6	.90
2B4	1.10	6AX5GT	1.05	6W4GT	.85	14E6	1.15
2D21	.55	6AZ8	1.45	6W6GT	1.00	14E7	1.20
2X2	.75	6B2	1.15	6X5GT	.70	14F8	1.20
3A4	.75	6BA6	1.25	6X8	1.10	14H7	1.20
3A5	.75	6B7A	1.25	6X8	1.10	14H7	1.20
3AL5	.65	6BC4	.80	7A4	.75	14Q7	1.20
3AU6	.60	6BC7	1.15	7A5	.90	14R7	1.30
3AV6	.85	6BC8	1.25	7A7	.90	14S6	1.25
3BE6	.85	6BD5	1.25	7A7	.90	14W7	1.25
3BC5	.85	6BD6	.70	7AB	1.25	19AU4	2.20
3BN6	1.00	6BD6	.70	7AB	1.25	19AV6	2.20
3B8	.90	6BF5	.80	7AF7	1.00	19J6	1.10
3BY6	.85	6BF6	.65	7AG7	1.00	19T8	1.15
3CZ6	.85	6BG6	2.25	7AH7	1.00	12K7GT	1.00
3CB6	.85	6BH6	.95	7AU7	.90	25AV5GT	1.25
3CF6	.85	6BH8	1.25	7B4	.75	25AX4GT	1.05
3D7B	.80	6BJ6	1.00	7B5	1.00	25BK5	1.25
3FL4	1.25	6BJ7	1.00	7B6	1.00	25BQ6GT	1.55
3Q4	.75	6BK4	2.50	7B7	1.00	25CD6GA	2.00
3Q5GT	1.15	6BK5	1.15	7C7	1.00	25E5	1.60
3S4	.85	6BK7A	1.15	7C5	1.00	25L6GT	.80
3V4	.85	6BL7GT	1.35	7C6	.95	25W4GT	.95
4BC8	1.40	6BN6	1.00	7E7	1.20	25Z6GT	1.00
4BQ7A	1.40	6BN6	1.00	7E7	1.20	25Z6GT	1.00
4B8	1.35	6BQ6GT	1.50	7F7	1.00	25A5	1.00
4BU5	1.20	6BR7A	1.35	7F8	1.00	35B5	.75
4BZ7	1.40	6BR8	1.15	7G7	1.15	35C5	.75
5A6	2.10	6B8	1.45	7H7	1.10	35L6GT	.85
5AN8	1.15	6B8	1.45	7I7	1.00	35W4	.50
5AN8	1.25	6BX7GT	1.35	7K7	1.20	35Y4	.80
5AQ5	.75	6BY5G	1.25	7L7	1.30	35Z3	.85
5A8	1.20	6BY6	.80	7M7	1.20	35Z4	.65
5AT8	1.15	6BY8	.80	7N7	1.20	35Z5	.65
5AU4	1.30	6BZ6	.80	7R7	1.40	41	.90
5AV8	1.35	6BZ7	1.40	7V7	1.30	42	.80
5AW4	1.25	6BZ8/X155	1.40	7W7	1.30	43	1.00
5AZ4	.85	6C4	1.60	7X7	1.40	50A5	1.10
5BK7	1.20	6C4	1.60	7Y4	.80	50C5	.75
5BR8	1.20	6C4	1.60	7Z4	.80	50C5	.75
5BQ7	1.40	6C5	.80	8AW8A	1.40	50L6GT	.85
5CG8	1.15	6CB5	.80	8C7	.90	50M6GT	1.00
5J6	1.00	6CB5	.80	8CM7	.90	50V6GT	.75
5R4GY	1.50	6CD6G	2.25	12A4	.80	50V7GT	.75
5U8	1.15	6CC7	.85	12A5	.85	12K7GT	2.70
5U4GB	.80	6CC7	.85	12A7	1.25	81	.85
5V4	.80	6CC8	1.10	12A15	.65	81	1.75
5V4G	1.15	6CH8	1.25	12A25	1.00	83	1.25
5V6GT	.85	6CM6	.90	12A27	1.05	117L7GT	2.70
5W4GT	.80	6CN7	.85	12A45	.85	117P7GT	2.00
5X4G	.80	6CN7	.85	12A47	.85	117P7GT	2.00
5X8	1.15	6CR6	.85	12A46	.80	117Z3	.85
5Y3GT	.80	6C8	.95	12A56	1.10	117Z6GT	1.00
5Y4G	.80	6C8	.95	12A56	1.10	117Z6GT	1.00
5Z3	1.00	6C5	.80	12AX4GT	.95	5642	1.05

WRITE FOR LATEST TUBE CATALOG FREE!  
We stock over 1000 types including Diodes, Transistors, transmitting and Special Purpose types.

### 2-COLOR TUBE CARTONS

Keeps your tube stock neat. New safety partition prevents tube breakage. Distinctively lithographed in glossy red and black. The most distinctive tube carton available today. Minimum quantity: 100 of any one size. Write for case lot prices. Packed 1000 to case. F.O.B. N. Y. C.

SIZE For Tube Per 100  
Miniature . . . 6AU6, etc. . . \$1.00  
GT . . . . . 6SN7GT, etc. . . 1.25  
Large GT . . . 1B3GT, etc. . . 1.50  
Large G . . . 5U4G, etc. . . 2.00



### WHITE GLOSSY BOXES

Completely blank. No printing or color. Otherwise same as above. Same high quality, same low prices. Specify "WHITE" when ordering. When color is not stated, 2 color cartons will be shipped.

Write for Latest "Green Sheet" Catalogue Listing Hundreds of Equipment and Component Specials

TERMS: 25% deposit with order, balance C.O.D. All merchandise guaranteed for cost of merchandise only. F.O.B. N.Y.C.  
Subject to price variation and stock depletion  
We are near Prince St./BMT Station, Spring St./IRT Station. Open Monday thru Saturday. Thousands of unadvertised specials. Come in and browse around.

**BARRY ELECTRONICS CORP.**  
512 Broadway, Dept. RN, N.Y. 12, N.Y.  
Phone: Walker 5-7000

attenuators to handle any signal level found in most receivers or amplifiers, and visual and audible signal indica-

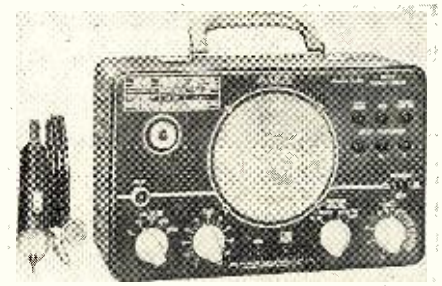

tors, plus output terminals for use with scopes or a v.t.v.m.

The instrument comes complete with all parts and a detailed construction and operation manual.

### TRANSISTORIZED TV CAMERA

Dage Television Division, Thompson Products, Inc., Michigan City, Ind., has developed a fully transistorized, automatic television camera which measures only 2 3/8" x 5 3/8" x 7 3/8".

This miniaturization has been made possible by replacing all tubes with transistors and all wires with printed circuits. To facilitate and speed maintenance the camera has been assembled

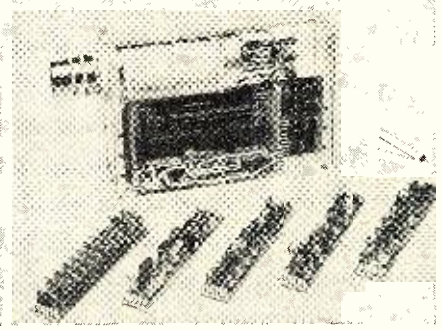

with modular components. The six basic modules in the unit are video amplifier, sweep amplifiers, synchronizing generator, binary strip, power supply, and oscillator strip.

The self-contained camera reduces the usual tangle of interconnecting electric lines to only one coaxial cable. In addition, since the camera has all the necessary auxiliary equipment built in, it will operate on almost any available power such as 117-volt a.c., 28-volt d.c., and even a miniature 7 1/2-volt battery.

### PHOTO CREDITS

Page	Credit
29	Jensen Mfg. Co.
31 (left)	Atlas Sound Corp.
31 (right)	Altec Lansing Corp.
32	Racon Electric Co.
36 (left)	Pickering & Company, Inc.
36 (right)	Neshaminy Electronic Corp.
37	Arnhold Ceramics, Inc.
39	Walt Disney Productions
56	Electronic Instrument Company
82	DuKane Corp.
94	Sargent-Rayment
106	International Telephone & Telegraph Co.
110	Hughes Aircraft Corp.
120	Acoustica Associates

**Multicore**  
FIVE CORE  
**WORLD'S FINEST SOLDER!**  
Made especially for the  
**RADIO AND ELECTRONIC MARKET**

Guarantees your work —  
**FASTER! SURER! NO CALL-BACKS!**

**LOWEST POSSIBLE PRICES —**  
**PROMPT DELIVERY**

**SOLD ONLY THROUGH**  
**RADIO PARTS DISTRIBUTORS!**  
Dept. MF48  
**MULTICORE SALES CORPORATION**  
PORT WASHINGTON, NEW YORK

**RAD-TEL TUBE CO.**  
1U4 SYLVANIA—RCA  
ORIGINAL  
JAN CARTONS  
EACH IND. BOXED  
BRAND NEW  
Lots of **24**¢  
Lots of 100 . . . . . 29¢  
Singly . . . . . 57¢

**SENSATIONAL!**  
**PICTURE TUBE**  
TEST and REPAIR Instrument  
SIMPLE, EASY-TO-USE

**REJUVA-CHECK**  
TESTS Checks emission, shorts & leakage; estimates life of CRT.  
REPAIRS Checks shorts & leakage, cathode contamination.  
REJUVENATES New life to dim tubes—restores emission.  
Reg. \$7.95—Made By **\$6.95**  
CENTURY. \$10.50 Value . . .

**FREE TV DYNATRACER**  
Reg. \$2.95 Dynamic TV Trouble Shooters  
FREE with REJUVA-CHECK Purchase!

**Rad Tel TUBE CO.**  
Not Affil. With Any Other Tube Mfg. Order Co.  
55 Chambers Street Newark 5, N. J.

Write Dept. RN-6 For FREE Catalog of Parts. Subject to prior sale. No C.O.D.'s please. Allow for postage.



# CLASSIFIED

RATE: 50¢ per word. Minimum 10 words. August issue closes June 10th. Send order and remittance to: RADIO & TV NEWS, 1 Park Ave., N. Y. C. 16, N. Y.

## RADIO ENGINEERING

ELECTRONICS! Associate degree—29 months. Technicians, field engineers, specialists in communications, missiles, computers, radar, automation. Start September, February. Valparaiso Technical Institute, Dept. N, Valparaiso, Indiana.

## FOR SALE

TUBES—TV, Radio, Transmitting And Industrial Types At Sensibly Low Prices. New, Guaranteed, 1st Quality, Top Name Brands Only. Write For Free Catalog or Call WALKER 5-7000, Barry Electronics Corp., 512 Broadway, New York 12N, N. Y.

TELEVISION Sets \$11.95. Plus shipping. Jones TV, 147 High, Pottstown, Pa.

TUBES—Television, Radio, Guaranteed. Boxed, 75% off. Bell Electronics, 40 Canal, New York City 2.

DIAGRAMS for repairing radios \$1.00. Television \$2.00. Give make, model. Diagram Service, Box 672-RN, Hartford 1, Conn.

RADIO & TV Tubes at manufacturers prices. Guaranteed—Send for free price list. Edison Electronic Tube Co., Menlo Park, N. J.

GOVERNMENT Sells—Surplus Electronics; Walkie-Talkies; Transceivers; Test Equipment; Oscilloscopes; Radar; Voltmeters; Misc.—Fraction of Army costs—Buy direct now from U. S. Government—"Depot List & Procedure" \$1.00—Brody, Box 8-RT, Sunnyside 4, New York.

GOVERNMENT Surplus Snooper scopes, Radios, Mine Detectors, Parabolic Reflectors, Parts. Picture catalog 10¢. Meshna, Malden 48, Mass.

LABORATORY Oscilloscope New—5 MC. Direct from factory guaranteed. Kit price \$142.—Write for free literature. Electronic Industries, Patterson, N. Y.

DIAGRAMS! Repair Information! Radios—amplifiers—recorders \$1.00. Televisions \$1.50. Give make, model, chassis. TV Miltie, Box 101RA, Hicksville, New York.

RECONDITIONED Used Television 17", 21", 24" & 27" Table Model & Console, 150 sets to choose from. Wholesale prices—For list Write to Horn's Radio & TV, 1621 California Street, Columbus, Indiana.

TELEVISION & Radio Tubes, Parts and Supplies at low prices. One year Guarantee. Write Hi-Quality Tube Co., Inc., 284 Lafayette St., Rahway, New Jersey for Free price list. Distributorship openings.

## WANTED

ART-13/T47A Transmitter \$100.00. ART-13/T47 Transmitter \$65.00. BC-788C Altimeter \$75.00. R5/ARN-7 Radio Compass \$60.00. BC-348 Rec'r Unmod. Q & R Models \$35.00. ARC-1 Transmitter \$90.00. AN/ARN-14C Radio Receiver \$250.00. Ship via express, C.O.D. Subject to Inspection to: H. Finnegan, 49 Washington Avenue, Little Ferry, New Jersey.

CYLINDER and old disc phonographs. Edison, Conqueror, Idelia, and Oratorio models. Berliner Gramophones and Zono-ophones, Columbia cylinder Graphophones, and coin-operated cylinder phonos. Want old catalogues and literature on early phonos prior to 1919. Will pay cash or trade late hi-fi components. Classified Box 50 % Radio & TV News, 1 Park Ave., N. Y. C. 16, N. Y.

CASH Paid! Sell your surplus electronic tubes. Want unused, clean transmitting, special purpose, receiving, TV types, magnetrons, Klystrons, broadcast, etc. Also want military & commercial lab test and communications gear. We swap too, for tubes or choice equipment. Send specific details in first letter. For a fair deal write, wire or telephone: Barry, 512 Broadway, New York 12, N. Y. WALKER 5-7000.

WANTED: Receiver R5/ARN-7, MN-62A Transceivers, RT18/ARC-1, AN/ARC-3, BC-788C, I-152C, Collins, Bendix equipment, Test Sets, Dynamotors, Inverters. We pay highest prices. Advise quantity, condition, price first letter. Aircraft Radio Industries, Inc., 70 East 45th St., N. Y. 17, telephone LEXington 2-6254.

June, 1958

## NOTICE

In replying to box numbers be sure to address letters to

## RADIO & TV NEWS

1 Park Ave.  
New York 16, N. Y.

Note: This does not apply to box numbers where city and state are shown

LABORATORY Quality Equipment and Military Surplus Electronics bought, sold. Engineering Associates, 432 Patterson Road, Dayton 9, Ohio.

TIMEX magnetic recorder, spare heads. Divitbiss, 108½ Daniel, Champaign, Illinois.

WANTED—Raytheon 2J23 magnetron tubes. Wire quantity, condition and price. KWTV, Okla. City, Okla.

## HIGH FIDELITY

PRICES? Try ours! Everything in Hi-Fi. Factory-sealed components. Write right now. Audion, 64-62 Booth St., Rego Park 74, N. Y.

DISGUSTED with "HI" HI-FI Prices? Unusual Discounts On Your High Fidelity Requirements. Write. Key Electronics, 120 Liberty St., New York 6, N. Y. EVergreen 4-6071.

WORLD Renowned Hartley Speakers now available to Dealers, Servicemen, Custom Installers, lowest franchise requirements in high fidelity. Write Hartley Products Company, 521 East 162 Street, New York 51, N. Y.

DISCOVER our "Six Unique Services" on Hi-Fi; Stereo. Complete line. Write The Silver Trumpet, 406R Walnut, Alexandria, Indiana.

## TAPE & TAPE RECORDERS

RECORDERS. HiFi. Tapes. Free Wholesale Catalog. Carston 215-R East 88 St., N. Y. C. 28.

TAPE Recorders, hi-fi components, tapes. Unusual Values. Free catalog. Dressner, 69-02 R, 174 St., Flushing 65, N. Y.

DISCOUNTS to 50%. recorders, tapes, hi-fi components, consoles, photograph equipment. Request specific prices only. Long Island Audio & Camera Exchange, 3 Bay 26th Street, Brookline 14-N, N. Y.

## RECORDS

PHONOGRAPH Records cheap, postpaid. Catalogue. Paramount, Box 242-N, Williamsport, Penna.

## EXPECTING AN ORDER?

You'll get it quicker if your postal delivery zone number is on the order blanks, return envelopes, letterheads.

The Post Office has divided 106 cities into postal delivery zones to speed mail delivery. Be sure to include zone number when writing to these cities; be sure to include **your** zone number in **your** return address—after the city, before the state.

## REPAIRS & SERVICING

ALL Makes High Fidelity Speakers Repaired. Amprite, 70 Vesey St., N. Y. 7, N. Y. BA 7-2580.

## BUSINESS OPPORTUNITIES

THIS space could be doing a selling job for you—reaching over 245,000 people who read Radio & TV News each month. If you have something to sell, place an ad in the Radio & TV News classified section for fast results. Rate: 50¢ per word. Minimum 10 words. Send order and remittance to Martin Lincoln, Radio & TV News, One Park Avenue., New York 16, New York.

HIGH Paying Jobs, Opportunities, foreign, USA. All trades. Companies pay fare. For information Write Dept. 59L, National Employment Information, 1020 Broad, Newark, New Jersey.

NEW German miracle gems! Titania's replacement. \$2.00 carat. MexTex, 721RTV, El Paso, Texas.

SELF-SERVICE Tube Testers \$25 to \$50. Used-reconditioned complete with signs and floor model cabinets. Get into a profitable business with a minimum investment. Write, Ed Moerke, P. O. Box No. 264, Zion, Ill.

## TECHNICAL INSTITUTES

A.S. DEGREE in Electronics Engineering Technology in 24 months. Shorter resident or home study courses in Electronics, Radio-TV Servicing, Broadcasting, Airlines. G. I. approved. Low tuition. Free catalog. Central Technical Institute, Dept. W-68, 1644 Wyandotte, K. C. 8, Mo.

## CORRESPONDENCE COURSES

USED Correspondence Courses and Books sold and rented. Money back guarantee. Catalog free. (Courses bought.) Lee Mountain, Pisgah, Ala.

## INSTRUCTION

ENGINEERING Degrees, EE Option Electronics earned by home study. Residence classes also available. Pacific International University (operating as a college of engineering only at present), 5719-C Santa Monica Boulevard, Hollywood 38, California.

MISSILE Electronics: Learn basic circuits of transistors and magnetic amplifiers as used in Missiles and Satellites. Send \$1.00 for booklet. Kits also available. Box 8087, Long Beach 8, Calif.

## MISCELLANEOUS

TRADE-IN TV. Ship anywhere. \$9 up. Write Justis Bros., Newport, Del.

SAVE Money! Don't Buy until you get Our price list! All types Radio & TV tubes at Mfrs. prices! 100% Guaranteed! 24-Hour Service! Write United Radio Co., Newark, N. J.

1000 name and address labels for \$1! Pocket rubber stamp \$1! Send postcard for many other bargains! Hillhouse, Box 179, Syracuse 1, N. Y.

DECALS—Trademarks, Service, Sales, etc. Write Allied Decals, Inc., 8378 Hough, Cleveland, Ohio.

SAVE Money. Time. We build kits and custom cabinets. Send kit or kit cost + 30%. Ask for cabinets. Hopps, 6925 59th Road, Maspeth 78, N. Y.

U. S. Navy's excellent books, Basic Electricity, 684 pages, \$2.25; Basic Electronics, 728 pages, \$2.25. No C.O.D.'s. Foster, Box 703, Silver Spring, Maryland.



**"TAB" Tubes Tested, Inspected, Boxed**

Guaranteed **FIRST-QUALITY** Surplus  
Postpaid Orders \$10 Receiving #'s 48 States

0A2	.80	6B16	.72	12A76	.59	11723	.69
0B2	.72	6B17	.99	12A77	.89	11726	1.10
0C3	.84	6B17	1.95	12AUG	.63	424A	2.00
0D3	.80	6B18	1.08	12A17	.68	2051	2.65
0Z4	.50	6BQ6	1.19	12AX7	.79	2221	.68
1A7	1.00	6BZ7	1.25	12BA6	.65	3023	5.00
1B3	.74	6C4	.44	12BA7	.99	717A	5.41
1R5	.78	6C5	.69	12BD6	.59	4-125	29.00
1S4	.78	6CB6	.80	12BE6	.59	4-250	35.00
1T4	.78	6CD6	1.49	12BF6	.59	4E27	7.00
1U4	.68	6H6	.59	12BH7	.99	4E60	29.50
1U5	.85	6H7	.59	12BT6	1.00	4X150	19.00
1X2A	.68	6J6	.59	12BZ7	.99	4X250	35.00
3Q4	.68	6K6	.59	12CUG	1.45	4X500	38.00
3Q5	.86	6K7	.79	12SA7	.79	4E10	3.98
3S4	.68	6L6	1.19	12SG7	.89	5BP4	1.98
3V4	.99	6S4	.59	12SH7	.89	35T	4.00
SR4	1.25	6S8	.99	12S17	.75	40T	7.00
5U4	.59	6SA7	.69	12SK7	.75	250T	20.00
5V4	.89	6SB7	1.19	12SQ7	.69	388A	1.00
5V3	.59	6SC7	.89	198G6	2.15	418A	14.00
6AB4	.59	6SC7	.78	19T6	1.16	450T	43.00
6AC7	.75	6H7	.69	25RQ6	1.39	807	4.10
6AG7	.89	6S17	.69	25L6	.72	808	1.00
6AH6	.99	6S17	.72	25W4	.77	809	3.00
6AK5	.69	6S17	.89	25Z6	.79	810	1.00
6AL5	.59	6SN7	2/31	25Z6	.75	811	3.00
6AQ5	.66	6SQ7	.74	EL34	3.49	812	3.00
6AS7	3.20	6SR7	.79	EL37	2.49	813	9.00
6AT6	.49	6T8	.98	35L6	.59	814	2.45
6AU4	1.29	6U8	.98	35W4	.52	815	2.50
6AU5	1.19	6V6	1.39	35Y4	.69	829B	8.00
6AU6	.69	6W4	.89	50A5	.69	866A	1.60
6A4	.79	6W6	.89	50A5	.69	866A	1.60
6BA6	.59	6X4	.39	50B5	.69	6146	4.00
6BA7	1.00	6X5	.49	50C5	.69	5879	1.20
6BD6	.69	6Y6	.69	50D5	.69	5000	2.70
6BE6	.59	7N7	.89	KT66	3.29	6550	3.90
6BG6	1.50	12AL5	.59	75	.89	5842	11.00
6BH6	.75	12AQ5	.75	20A5	.59	5554	1.00

Write for Complete Tube List! Discounts to Qty. Buyers  
**TUBES WANTED! WE BUY! SELL & TRADE!**

**FINEST HI-FI RECORDING TAPE**  
1200 Ft.—7" Reel **\$1.45** Lots of 3  
Money Back Gtd.

Highest quality controlled plastic base tape made by new Erin process. Precision coated & silt. Gtd. Constant output. Soli. Free. Freq. 7 1/2 IPS. 40-15KC Outside Wnd In. New 1st Quality "Mylar" 2400 Ft.—7" Reel Ferro Erin Gloss Process Recording tape. \$4.49, 3 for \$12

**DIAMOND PHONO-NEEDLES** Postpaid 48 States!  
REGISTERED ONE YR. GUARANTEED BY THE MFR!  
ALL MAKES LP&78—ONE DIAMOND...\$7  
TWO DIAMONDS \$14; DIAMOND & SAPPHIRE...\$8  
PLEASE SEND CARTRIDGE NAME & NUMBER

**NEW VR11 "GE" PHONO CARTRIDGES!!**  
Postpaid 48 States!  
4G061/LP or 4G063/78 DIAMOND...\$16  
4G050/LP&78 TRI-PLAY...\$8.59  
4G052/LP&78 TRI-PLAY DIAMOND & SAF...\$18  
4G053/LP&78 TRI-PLAY DIAMONDS...\$26

**WRITE FOR BONUS CATALOG**

Infrared Receiver Assembly USN/US/AM-R1400, direct viewing telescopic unit. Changes invisible infrared energy into a visible image on an inbuilt screen. Includes infrared filter, radioactive charging system. Navy cost \$216 includes inst case & data. Special \$21.

**NEW "TEKSEL" SELENIUM BRIDGE RECTIFIERS. ONE YEAR GTD!**

**FULL WAVE BRIDGE • WRITE FOR CATALOG**

CURR.	18VAC	36VAC	72VAC	144VAC
CONT.	14VDC	28VDC	56VDC	112VDC
1AMP	\$ 1.30	\$ 2.60	\$ 5.20	\$ 10.40
2AMP	2.15	4.30	8.60	17.20
3AMP	2.90	5.80	11.60	23.20
6AMP	4.15	8.30	16.60	33.20
10AMP	6.10	12.20	24.40	48.80
15AMP	9.90	19.80	39.60	79.20
24AMP	15.00	30.00	60.00	120.00

**NEW GTD RADIO & T.V. RECTIFIERS**  
35MA 40c @ .6 for \$2; 65MA 45c @ .5 for \$2;  
75MA 49c @ .5 for \$2; 100MA 59c @ .6 for \$3;  
150MA 70c @ .9 for \$5; 250MA 79c @ .6 for \$3;  
300MA 88c @ .5 for \$4; 500MA \$1.00 @ .8 for \$7;  
400MA \$1.10 @ .5 for \$5; 500MA \$1.35 @ .4 for \$5;  
65MA/260V \$1.10 @ .9 for \$5; 100MA/260V \$1.25 @ .9 for \$5; 100MA/156V 95c @ .300MA/156V \$1.75, 3/55. Order \$10. Postpaid 48 States!  
New Silicon 500MA/Hi Temp/140V Rectifier H'mt Sealed with clip...\$1.55 @ .7 for \$10, 25 for \$33  
MFRS. & DSTRBTRS. WRITE FOR QTY. PRICES.

**HAMS NEW TRANSISTORIZED "TABPAK"**  
12 VDC to HI VDC POWER SUPPLY!!!  
Kit or Assembled. Filtered, small in size! Quiet! Light Wgt. Input 12 to 14VDC (Low Idle Current). Output 4500uA @ 250VDC up to 150mA/65 watts. Int. "TABPAK" Assembled TR39CB...\$35  
"TABPAK" Kit TR39CK...\$30

**DC POWER FOR TRANSISTORS!!**

Transistors! Filtered Power Supply Kit used to power transistor circuits, amplifiers, etc. Delivers 12VDC at 2AMPS filtered less than 0.5% ripple or 25VDC at 1A. TR39 Kit \$18; TR32W assembled & wired \$24.  
115VAC Inpt. Transformer & Full Wave Bridge Rectifier for 12VDC @ 2AMP. RECTRAN KIT RT1K...\$4.50  
RT1W Assembled & Wired...\$8.50  
RT2K Kit 12 or 18VDC at 6 AMPS...\$9.00  
RT2W Assembled & Wired...\$14.75

**KITS! "TAB" THE BEST KITS!**

All Kits Contain Most Popular Values & Sizes  
Kit 35 Precision Resistors Kit 35 Power Resistors  
Kit 18 Switches Kit 75 Mica Cond's  
Kit 3 Transistor Transf. Kit 6 Crystal Diodes  
Kit 150 Carbon Resistors Kit 8x25 ft. Hookup Wire  
Kit 42 Panel Lamps Kit 100 Fuses  
Kit 12 Electrolytic Cond's Kit 100 Ceramic Cond  
Kit 15 Volume Controls Kit 18 Rotary Switches  
Kit 36 Tube Sockets Kit 6 Crystals & Holders  
Kit 50 Tubular Cond's Kit 65 Inductors & Coils  
Kit 500 Lugs & Eyes Kit 6 Microswitches  
Kit 10 Xmit Mica Cond's Kit 10 Wheat Lamps  
Kit 5 Lbs. Surprise Kit Kit 40 Insulators  
Kit 10 Xmit Mica Cond's Kit 85 Insulated Resist.  
Kit Encapsulation Fluid Kit TV Knobs  
Kit Volume Control Fluid Kit Glyptal Cement & Varnish

**"TAB"** TERMS: Money Back Guarantee! Our 14th year. \$2 min order. F.O.B. N.Y.C. Add. ship. charges or for C.O.D. 25% Dep. Prices shown subject to change.  
111R LIBERTY ST., N. Y. 6, N. Y. Catalog  
Write for PHONE: RECTOR 2-6245

**INDEX OF**

**Advertisers**

JUNE 1958

While every precaution is taken to insure accuracy, we cannot guarantee against the possibility of an occasional change or omission in the preparation of this index.

ADVERTISER	PAGE	ADVERTISER	PAGE
Advance Electronics	118	Minnesota Mining and Manufacturing Company	90
Aermotor Company	92	Moerke, Ed.	122
Airex Radio Corporation	120	Moss Electronic Distributing Co., Inc.	84, 85
Allied Radio Corp.	9, 21	Multicore Sales Corporation	128
Arky	108	National Radio Institute	3
Arrow Sales, Inc.	126	National Schools	13
Ash Radio Co., Walter	117	North American Phillips Co., Inc.	87
B & K Manufacturing Co.	63	Northrop Aeronautical Institute	112
Baltimore Technical Institute	122	Nortronics Company, Inc., The	122
Barry Electronics Corp.	128	Oelrich Publications	111
Bell Telephone Laboratories	THIRD COVER	Offenbach-Reimus	16
Bozak Sales Co., The R. T.	8	Olson Radio Warehouse	127
Brooks Radio & TV Corp.	106	Orradio Industries, Inc.	86
C.B.C. Electronics Co., Inc.	22	Pacific International University	122
CBS-Hytron	6	Peak Electronics Company	114
C & H Sales Co.	123	Perma-Power Company	88
Candler System Co.	118	Picture Tube Outlet	115
Capitol Radio Engineering Institute	7, 83	Pilot Radio Corporation	12
Carston	115	Platt Electronics Corp.	103
Center Electronics Co., Inc.	119	Popular Photography Contest	123
Century Electronics Co., Inc.	91	Postal Zone	129
Channel Master Corp.	26	Progressive "Edu-Kits" Inc.	113
Chicago Standard Transformer Corporation	101	Quality-Electronics	115
Cleveland Institute of Radio Electronics	81	Quam-Nichols Company	22
Columbia Electronics	121	Quietrol Company	113
Coyne Electrical School	103, 109, 120	RCA Institutes, Inc.	23
Cutick Electronics	118	RW Electronics	113
DeVry Technical Institute	5	Rad-Tel Tube Co.	128
Dressner	115	Radio & Electronic Surplus	101
Dynaco Inc.	88	Radio & TV News Classified	121
Ebe, Inc.	111	Radio Corporation of America	88
Edmund Scientific Co.	119	Raytheon Manufacturing Company	
EICO	27, 28		SECOND COVER
Electro-Sonic Laboratories, Inc.	90	Record Changer Service	107
Electro-Voice, Inc.	19	Reeves Soudercraft Corp.	18
Electronic Chemical Corp.	117	Rek-O-Kut Company, Inc.	94
Electronic Experimenter's Handbook	125	Rex Radio Supply Co.	116
Electronic Organ Arts, Inc.	111	Rider Publisher Inc., John F.	14
Fair Radio Sales	107	Rinehart & Co., Inc.	115
Filnor Products Co.	125	Sams & Co., Inc., Howard W.	96, 119
Garrard Sales Corporation	16	Sarkes-Tarzian, Inc.	111
General Electric	89	Schober Organ Corp., The	109
Goodheart, R. E.	126	Scott, Inc., H. H.	20
Grantham Schools	100	Service Instruments Corp.	117
Greenwich Sales Co.	116	Sparks Radio Supply	126
Gyro Electronics Co.	101	Spaulding Products Company	102
Harvey Radio Co., Inc.	82	Sprayberry Academy of Radio-Television	15
Heath Company	64, 65, 66, 67, 68, 69, 70, 71, 72, 73, 74, 75, 76, 77, 78, 79	Stan-Burn Radio and Electronics Co.	116
Henshaw Radio Supply	115	Sylvania Electric Products Inc.	10, 11
Indiana Technical College	107	"TAB"	121, 130
Karlson Associates, Inc.	90	Telemarine Communications Co., Inc.	95
Lafayette Radio	98, 99	Telephone Engineering Co.	121
Lampkin Laboratories, Inc.	105	Terado Company	89
Lektron	124	Transvision, Inc.	121
Liberty Auto Radio, Inc.	97	Triad Transformer Corporation	104
McGee Radio Company	93	Tri-State College	16
M. R. Company, The	126	United Sales Company	22
Mallory & Co., Inc., P. R.	FOURTH COVER	University Loudspeakers, Inc.	24
Michigan Magnetics, Inc.	80	Valparaiso Technical Institute	111
Milwaukee School of Engineering	110	Ward Products Corp.	17
		World Radio Laboratories	109
		Xcelite, Inc.	105





1948—Early “point contact” transistor.

## The remarkable transistor observes its 10th birthday

In 1948, Bell Telephone Laboratories announced the invention of the transistor. In 1958, the transistor provided the radio voice for the first United States satellite.

To advance the transistor to its high level of usefulness, Bell Labs had solved problems which, in themselves, approached the invention of the transistor itself in scientific achievement.

First, there had to be germanium of flawless structure and unprecedented purity. This was obtained by growing large single crystals—and creating the “zone refining” technique to purify them to one harmful part in *ten billion*.

The “junction” transistor, another radical advance, spurred transistor use. Easier to design, lower

in noise, higher in gain and efficiency, it became the heart of the new electronics.

An ingenious technique for diffusing a microscopically thin layer on semiconductors was created. The resulting “diffused base” transistor, a versatile broadband amplifier, made possible the wide use of transistorized circuits in telephony, FM, TV, computers and missiles.

In telephony the transistor began its career in the Direct Distance Dialing system which sends called telephone numbers from one exchange to another.

For Bell System communications, the transistor has made possible advances which would have been impossible or impractical a brief decade ago.



1958—Satellite transistor, incorporating 10 years of Bell Labs research and development.



# BELL TELEPHONE LABORATORIES

WORLD CENTER OF COMMUNICATIONS RESEARCH AND DEVELOPMENT



... another  
**P. R. MALLORY & CO. Inc.**  
**MALLORY**  
service-engineered  
product

**CONVENIENT CARD-PACK**  
Buy Discaps on these handy cards  
... fits standard 3" x 5" file  
drawer ... 5 capacitors per card  
—tabbed for easy identification.



*Now available for service use*

# MALLORY- RMC DISCAPS®

*High-quality ceramic capacitors*

Long preferred in industrial electronics and by equipment manufacturers, Mallory-RMC Discaps are now ready for you to use on service jobs wherever you need dependable performance in even the most critical applications.

You're sure of tested quality—for Discaps are made under the most rigid quality controls, from basic raw materials to the finished unit. Every capacitor is tested for power factor, capacity, leakage resistance, and dielectric strength.

Discaps ... made by the world's largest manufacturer of ceramic disc capacitors ... are now available in the most popular ratings from your Mallory Distributor. See him today.

- Capacitors
- Vibrators
- Resistors
- Power Supplies
- Mercury and Zinc-Carbon Batteries
- Controls
- Switches
- Filters
- Rectifiers

